

COMPLETE U. S. BROADCAST STATION LIST



May
25 Cents
Canada 30c

Radio-Craft

HUGO GERNSBACK Editor

In This Issue
RADIO-CRAFT'S
Listener's
DX Forum

Constructing the
"RADIOLAMP"
Table Receiver
See Page 648

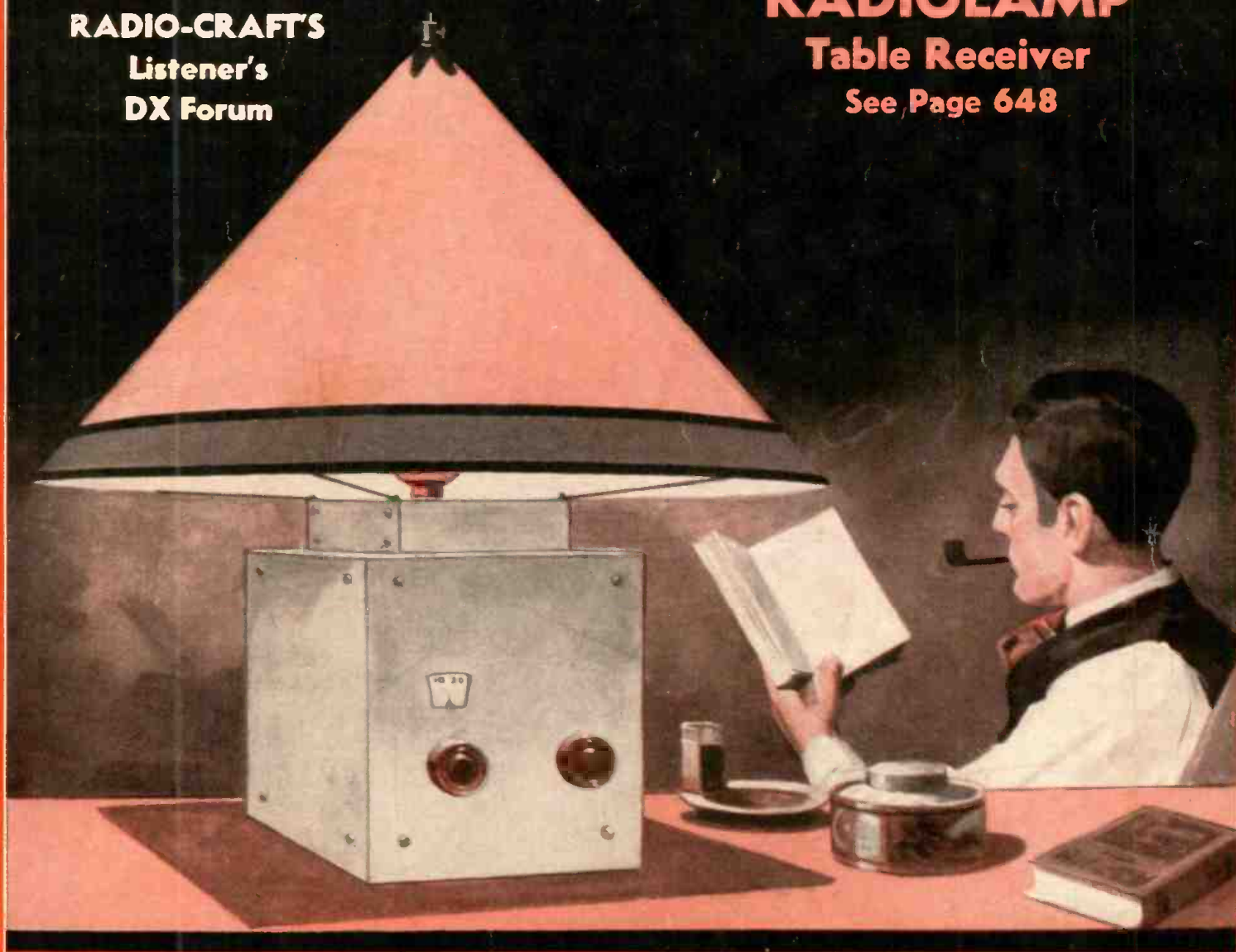

Broadcast Station List — Constructing A Micro-Midget Analyzer
Rewiring Sets For 2-Volt Tubes — A Battery-Operated Midget

RADIO'S LIVEST MAGAZINE



McMURDO~SILVER

THE ONLY CUSTOM-BUILT RECEIVER OFFERED FOR 10 DAY TRIAL

No strings to this offer. Try the Masterpiece 10 days. Keep it if you like it . . . or send it back for prompt refund.

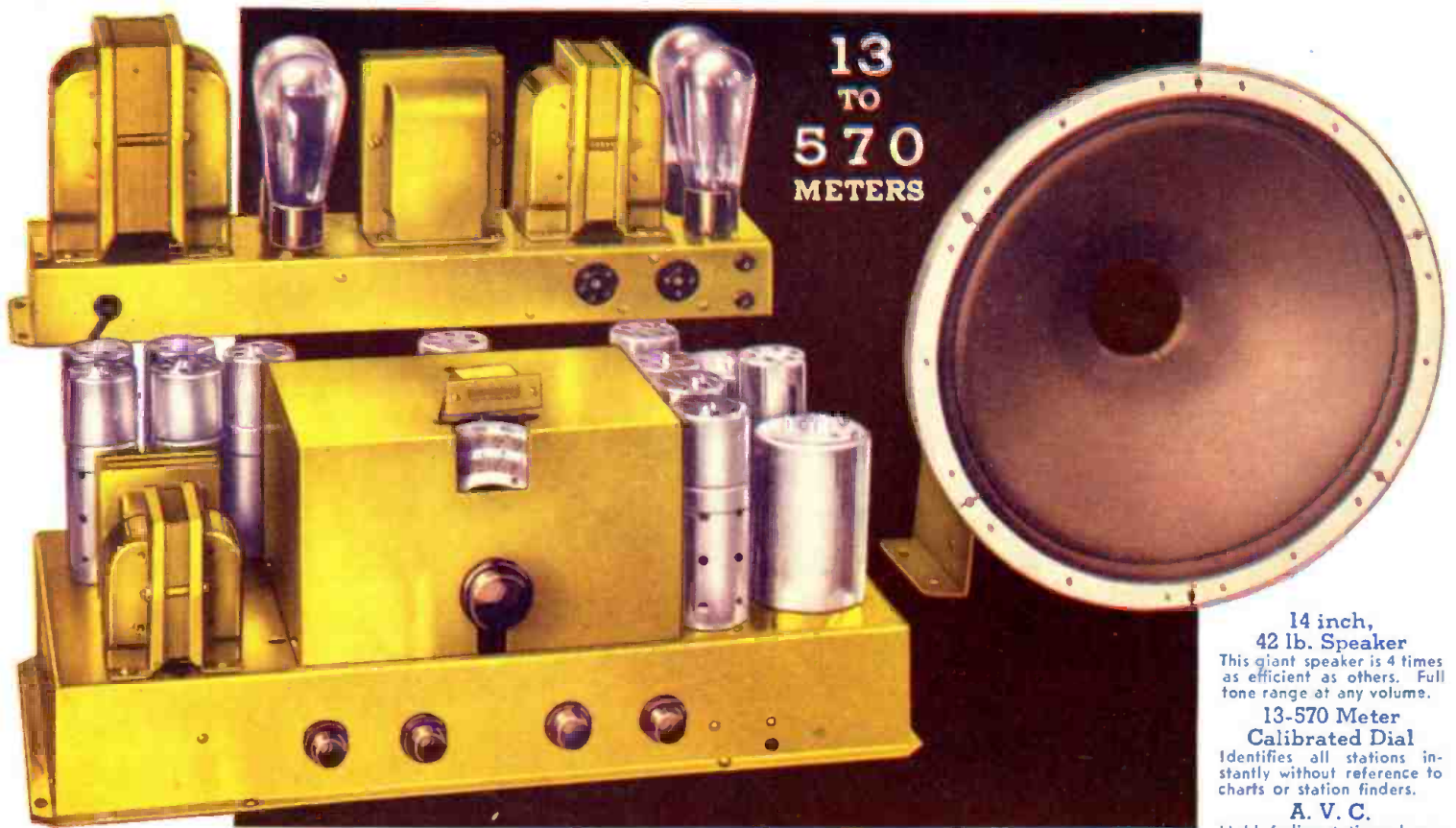

13
TO
570
METERS

14 inch,
42 lb. Speaker

This giant speaker is 4 times as efficient as others. Full tone range at any volume.

13-570 Meter
Calibrated Dial

Identifies all stations instantly without reference to charts or station finders.

A. V. C.

Holds fading stations at constant volume.

Manual and Automatic Tone Control
Gives any desired interpretation of musical programs at any volume.

Meter Tuning

Permits micrometrically accurate tuning.

Noise Squelch
Circuit

Cuts out all inter-station noise at the turn of a knob.

Audio-Beat
Oscillator

The throw of a switch makes very low-power foreigners easy to find.

Individual Curves

Personally made by myself on your own set, which they accompany.

Accurately Logged

On at least 3 European or Asiatic stations in final test.

NOW is the best time for European reception. But, you don't want to spend your money for an All-wave receiver until you KNOW, beyond all doubt, that the receiver you intend to buy will fully meet your expectations, and will actually give you the reception you hope to get. You are right. You should not be asked to gamble. Yet the Masterpiece is the only receiver you can buy, without gambling. The Masterpiece is the only custom-built radio in the world whose maker knows it to be so fine that he dares offer it to you for a ten day free trial in your own home, with only you to be the judge if it is satisfactory in every way before you decide it's the set you want. Good? The Masterpiece has got to be good to justify such a guarantee!

This is the most daring offer ever made by a maker of custom-built receivers. 10 day free trial! 10 days in which to prove to yourself, by any kind of test you can conceive of, right in your own home, that The Masterpiece is the finest All-wave receiver made today.

London, Paris, Berlin, Madrid, Lisbon and other foreigners are coming in at their best now—with excellent volume and clarity. You want to hear these stations clearly, distinctly . . . each word, each note sharply defined . . . exactly as though you were there. Hear them that way with The Masterpiece—on trial!

Send 6c in stamps for my 16-page book giving complete technical description of the Masterpiece and its many new and outstanding operating and performance features. Full details of my offer will be included. Please use the coupon from this announcement.

McMURDO SILVER INC.
1132 W. Austin Ave., Chicago.

Six cents in stamps enclosed. Send me your book giving full technical details and performance facts on The Masterpiece.

Name _____
Street _____
Town _____ State _____

McMURDO SILVER INC.

1132 West Austin Avenue

Chicago, U. S. A.

LEARN RADIO IN 10 WEEKS!

PAY FOR YOUR TRAINING AFTER YOU GRADUATE

I am making an offer that no other school has dared to do. I'll take you here in my shops and give you this training and you pay your tuition after you have graduated. Two months after you complete my course you make your first payment, and then you have ten months to complete your payments. There are no strings to this offer. I know a lot of honest fellows haven't got a lot of money these days, but still want to prepare themselves for a real job so they won't have to worry about hard times or lay offs.

I've got enough confidence in these fellows and in my training to give them the training they need and pay me back after they have their training.

If you who read this advertisement are really interested in your future here is the chance of a life time. Mail the coupon today and I'll give you all the facts.



A scene in the big, busy Radio Shops at Coyne. Here you see fellows working on real Radios—not reading about them from books or lessons. This is THE way to prepare for the big-money field of Radio!

TELEVISION *and* TALKING PICTURES

Television is already here! Soon there'll be a demand for THOUSANDS of TELEVISION EXPERTS! The man who learns Television now can have a great future in this great new field. Get in on the ground-floor of this amazing new Radio development! Come to COYNE and learn Television on the very latest, newest Television equipment. Talking Picture and Public Address Systems offer opportunities to the Trained Radio Man. Here is a great new Radio field just beginning to grow! Prepare NOW for these wonderful opportunities! Learn Radio Sound Work at Coyne on actual Talking Picture and Sound Reproduction equipment.

PREPARE NOW and be ready for Radio's many opportunities

Forget pay-cuts—lay-offs—unemployment! Don't be tied down to an untrained man's future. You NEED TRAINING IN A FAST-GROWING MONEY-MAKING TRADE. Here's your chance of a lifetime to get it! Hundreds of opportunities now open in Radio. My sensational offer, explained below, makes it possible for you to START AT ONCE!

The right way to learn Radio is the Coyne way—not by books, but by actual, practical work on actual Radio, Television and Sound equipment. Here at Coyne you'll service and operate scores of modern Radio receivers, huge Broadcasting equipment, late type Television apparatus, Talking Picture machines, Code transmitters and receivers, etc. In 10 weeks you can step into a REAL JOB, leading to a salary of \$50 a week and UP!

ALL PRACTICAL WORK At COYNE in Chicago

ALL ACTUAL, PRACTICAL WORK. You build radio sets, install and service them. You actually operate great Broadcasting equipment. You construct Television Receiving Sets and actually transmit your own Television programs over our modern Television equipment. You work on real Talking Picture

machines and Sound equipment. You learn Wireless Operating on actual Code Practice apparatus. We don't waste time on useless theory. We give you the practical training you'll need—in 10 short, pleasant weeks.

MANY EARN WHILE LEARNING

You get Free Employment Service for Life. And don't let lack of money stop you. Many of our students make all or a good part of their living expenses while going to school and if you should need this help just write to me. Coyne is 33 years old. Coyne Training is tested—proven beyond all doubt. You can find out everything absolutely free. Just mail coupon for my big free book!

H. C. LEWIS, Pres. RADIO DIVISION Founded 1899
COYNE ELECTRICAL SCHOOL
500 S. Paulina St., Dept. 53-8H, Chicago, Ill.

Mail Coupon Today for All the Facts

H. C. LEWIS, President
Radio Division, Coyne Electrical School
500 S. Paulina St., Dept. 53-8H, Chicago, Ill.

Dear Mr. Lewis: Send me your big FREE Book; details of your FREE Employment Service; and tell me all about your special offer of allowing me to pay for training on easy monthly terms after graduation.

Name.....
Address.....
City..... State.....



OUR JUNE ISSUE IS A SPECIAL
AUTOMOTIVE RADIO NUMBER

See Page 652

HUGO GERNSBACK, Editor-in-Chief

LOUIS MARTIN
Associate Editor

R. D. WASHBURNE
Technical Editor

CONTENTS OF THE MAY, 1933, ISSUE

VOLUME IV NUMBER 11

Editorial—DX Listening.....	Hugo Gernsback.....	647
How to Build the "Radiolamp" Table Receiver.....	Clyde Fitch.....	648
The Latest Radio Equipment.....		651
The Vest-Pocket, Seven-Tube Superhetero-Ultradyne.....	Ulysses Fips.....	654
Building a Battery-Operated "Personal" Receiver.....	H. G. Cisin.....	657
Building a Laboratory-Standard Analyzer.....	Leon J. Littmann.....	658
Making Money with Amplifiers, Part V.....	Hubert L. Shortt and Frank Lester.....	660
Constructing the Micro-Midget Analyzer.....	George G. Serotta.....	662
The Multitester—A Volt-Ohmmeter and Milliammeter.....	Milton Reiner.....	664
Readers' Department.....		665
Operating Notes.....	Bertram M. Freed.....	666
Rewiring R.C.A. and A.K. Sets for 2-Volt Tubes.....	David Hoyle.....	668

RADIO SERVICE DATA SHEETS:

No. 89 R.C.A. Victor R-27, and Philco 53 Ultra-Midget A.C.-D.C. Receivers.....		670
No. 90 Fada 103 Fadalette, Stewart-Warner Series 108, and DeWald 54 Dynette Sets.....		671
Broadcast Stations of the U. S.....		672
The DX Listener's Forum.....		675
Radio Craft's Information Bureau.....		676
A Super-Sensitive All-Wave Crystal Set.....	J. M. Nighswander.....	680
Quasi-Optical Home Experiments.....	John B. Brennan, Jr.....	682
Book Review.....		697

IN OUR NEXT FEW ISSUES:

HOW TO MAKE AN ULTRA-MIDGET CAR RADIO SET. Because of the extreme adaptability of the little A.C.-D.C. ultra-midget sets, many set makers have provided for their use with battery supply, and are recommending their use as an automotive receiver. However, while most of these sets are extremely convenient to use, due to their portability and ready adaptability to any convenient 6 V. current outlet, such as a dash-board or instrument-board light socket, they lack the extreme sensitivity and A.V.C. feature of most automotive sets. To meet this demand, there has been designed a new "ultra-midget": a car radio receiver which the average set builder will have no difficulty in constructing. Build this new "money maker."

THE AUXILIARY ANALYZER AND TUBE TESTER. This interesting device picks up the problem of set and tube testing where older analyzers leave off, and enables the Service Man to continue the use of his old tester in the service of new sets and tubes.

RADIO-CRAFT is published monthly, on the fifth of the month preceding that of date; its subscription price is \$2.50 per year. (In Canada and foreign countries, \$3.00 a year to cover additional postage.) Entered at the post office at Mt. Morris, Ill., as second-class matter under the act of March 3, 1879. Trademark and copyright by permission of Gernsback Publications, Inc., 98 Park Place, N. Y. C. Text and illustrations of this magazine are copyright and must not be reproduced without permission of the copyright owners. We are also agents for WONDER STORIES and WONDER STORIES QUARTERLY. Subscription to these magazines may be taken in combination with RADIO-CRAFT at reduced Club rates. Write for information.
Copyright 1933. GERNSBACK PUBLICATIONS, INC.

HUGO GERNSBACK, President
S. GERNSBACK, Treasurer

J. M. HERZBERG, Vice-President
I. S. MANHEIMER, Secretary

Published by TECHNI-CRAFT PUBLISHING CORPORATION. Publication office: 404 N. Wesley Ave., Mount Morris, Illinois. Editorial and Advertising Office: 96-98 Park Place, New York City. Chicago Advertising Office: 737 North Michigan Avenue, Chicago, Ill. Western Advertising Office: 220 No. Catalina St., Los Angeles, Calif. L. F. McClure, Chicago Advertising Representative. Loyd B. Chappell, Western Advertising Representative.

London Agent: Hachette & Co., 3 La Belle Sauvage, Ludgate Hill, E.C. 4
Paris Agent: Hachette & Co., 111 Rue Reaumur
Australian Agent: McGill's Agency
179 Elizabeth St., Melbourne

Tricks of a "Sound" Wizard

Since sound effects are to radio dramas what scenery is to the stage, one of the most important roles in any radio program is that enacted by a star performer who is neither personally heard nor seen by the listening audience. Yet his task is of the utmost importance if the background of microphone-play is to seem realistic. Such an invisible wizard is Albert J. Sinton, sound director of the World Broadcasting System, whose ingenious effects have added materially to the living realism achieved by that organization in the reproduction of its popular electrical transcriptions.

Born in England, Sinton came to the United States when five years old, and soon after his school days developed an ear for music. It was as a drummer in a theatre orchestra in Utica, New York, that he began his unique career and later with the advent of the silent screen was engaged by a local motion picture house to watch the pictures shown, and with his drum and varied gadgets, produce the sound of winds and waves, railroad and steamboat whistles, and similar effects as the films unreel.

During the course of that experience, Sinton devised a unique sound effect cabinet operated by electricity and compressed air. Installed in this console cabinet were the means of making about fifty standard sound effects such as those of trains, airplanes, automobiles, and like familiar noises, and soon thereafter Sinton found himself being referred to as "the wizard of sound." Operated by push buttons from a control board, this device was at once adopted by the screen when the talkies came into being. It then came to the notice of the W. B. S. and Sinton was offered the post of Chief Sound Technician in the New York studios of that organization.

In addition to his magic cabinet, however, Sinton is the originator of the means of realistically producing many sound effects now familiar to the ears of the listening audience. For instance the effect of footsteps crunching in the snow as required in making broadcasts of the adventures of the Northwest Mounted Police more thrilling. This colorful effect is produced by crunching the fat enclosed in a glove in a bowl of cornstarch.

Not only do many of Sinton's devices add realism but reduce production expense. Before he set to work to solve the problem, scripts that called for the sound of marching feet required the presence of as many supers as the W. B. S. studios could hold. Naturally this was costly as well as inconvenient, so Sinton invented an apparatus which gave the illusion of a marching host quite as well, if not better, than the footsteps of an actual mob. His invention was a frame about eighteen inches square with a number of wooden blocks suspended from its center. By

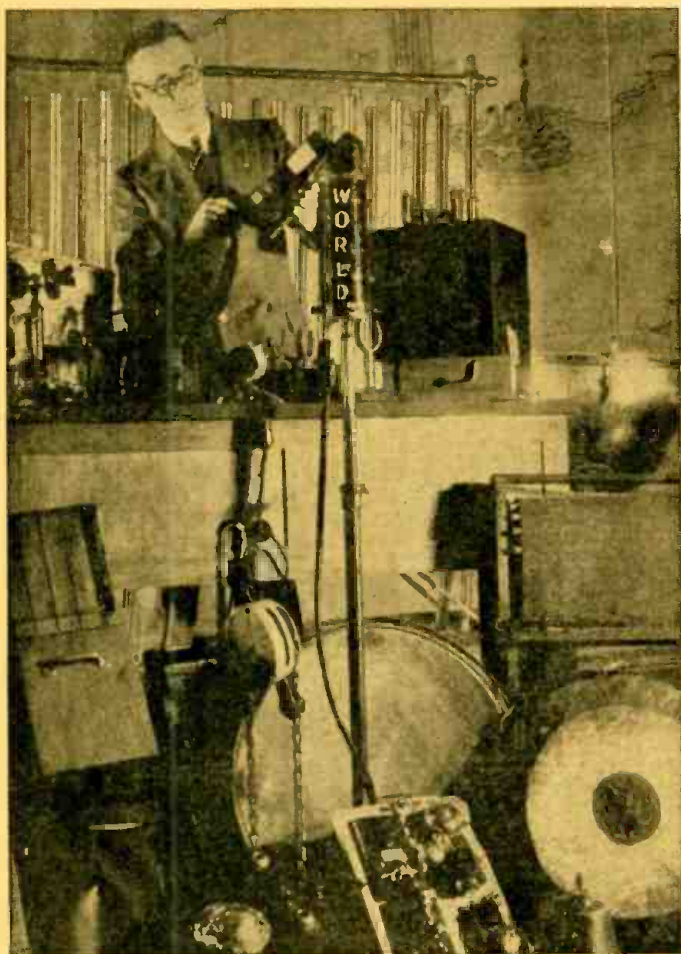

In this view, Albert J. Sinton, sound genius of World Broadcasting System, is shown surrounded by some of his numerous inventions for foxing the public via the "air" lanes. At the moment, he is producing the sound effects incident to the whine of shells in the course of a World War drama for the microphone. "You can't judge an effect by its sound!"

POST CARD

PLACE
1c
STAMP
HERE

Mr. J. E. Smith, President

National Radio Institute

Dept. 3EX

Washington, D. C.

POST CARD

PLACE
1c
STAMP
HERE

Lincoln Radio Corporation

Dept. E335

329 South Wood Street

Chicago, Illinois

POST CARD

PLACE
1c
STAMP
HERE

Mr. H. C. Lewis, President

Coyne Electrical School, Dept. 53-8H

500 South Paulina Street

Chicago, Illinois

POST CARD

PLACE
1c
STAMP
HERE

E. H. Scott Radio Laboratories, Inc.

Dept. C-53,

4450 Ravenswood Avenue

CHICAGO, ILLINOIS

Mr. J. E. Smith, President
National Radio Institute
Dept. 3EX,
Washington, D. C.

Without obligating me, send free book about spare time and full time Radio opportunities and how I can train for them.

Name

Address

City..... State.....

May RADIO CRAFT

Lincoln Radio Corporation
Dept. E335, 329
Chicago, Illinois, U. S. A.

Please send me Free Technical description of the

R-9

SW-33

Name

Address

City..... State.....

May RADIO CRAFT

Mr. H. C. Lewis, President
Coyne Electrical School
Dept. 53-8H, 500 So. Paulina St.
Chicago, Illinois

Without obligation send me your big free catalog and all details of Railroad Fare to Chicago, Free Employment Service, Radio, Aviation, Electricity, and Automotive Courses, and how I can "earn while learning" as per your advertisement in RADIO-CRAFT.

ALSO TELL ME ABOUT YOUR "PAY AFTER GRADUATION OFFER."

Name

Address

City..... State.....

May RADIO CRAFT

E. H. Scott Radio Laboratories, Inc.
Dept. C-53, 4450 Ravenswood Avenue,
Chicago, Illinois

Send me all details regarding the SCOTT ALL-WAVE DELUXE RADIO, including technical data, performance proofs and prices. This is not to obligate me.

Name

Address

City..... State.....

pounding these blocks on the floor with a rhythmic movement, the sound of the tramp of many feet was perfectly produced.

"Sometimes," said Sinton, "the effect of applause is reproduced from a previous electrical transcription of the approval of a living audience and "dubbed-in" on the transcription being made. Other times it is found more satisfactory to have an actual gathering in the studio to laugh and clap their hands.

"One of the most difficult effects I have ever been asked to create was the squeak of the chains of a porch hammock. I tried all sorts of things, including a real hammock swinging in the studio," Sinton continued, "but none sounded natural over the mike, for all too frequently that temperamental instrument absolutely refuses to reproduce actual sounds realistically. So in the case of the hammock chains, I finally won out by drawing a tooth-pick back and forth across the teeth of a small nail file."

Another novel method this "wizard" has devised is the scraping of a wire brush over a piece of corrugated tin mounted on a resonating box. The result is a perfect simulation of a locomotive going at full speed over a bridge! Not satisfied with that, however, Sinton desired a complete cabinet of railroad noises, so it was arranged that he might actually ride in an engine cab with his notebook as his companion. During the trip, Sinton took notes on the various sounds he heard while the train was in motion—the engineer's signal, the shoveling of coal, clicking of wheels on the rails, the steam exhaust, whistles and bells—everything which would add realism to a thrilling series of railroad broadcasts. Then after weeks of experiment, he solved each need and achieved his "railroad" cabinet.

Working with him, Sinton has a trained crew of sound producing experts, the forte of one of whom is animal imitations. In spite of that assistance, however, Sinton once found himself stumped by the need to produce the sound of horse's hoofs. He at last achieved it with a rubber plunger, such as is used by plumbers, but at the close of the program a colored porter burst into the studio and called out "Oh, Mr. Sinton, lend me one o' your horses. The sink outside's plugged up!"

Still other devices of Sinton's are apparatus to create the illusion of waves and the splash of swimmers diving into water. Another is his "rain making" machine which performs its task by dropping sand on parchment paper, while his wind-maker is a motor shaft equipped with rattan sticks which revolve and fan the studio air. In one script where an automobile starter was required to be heard, Sinton found that except for having an actual starter mounted, this effect was a tough nut. But he stumbled across its solution in the form of an emery wheel mounted and in motion. Once asked if he could give the effect of falling snow, Sinton replied that he could and stood silent without moving. "Perfect!" pronounced the director and Sinton took a bow. At the present time, however, he is experimenting with the feasibility of an actual electrical recording of wind and other natural sounds.

Up until a short time ago, sound effects previously recorded for "dubbing in" were fed into the electrical transcription disc by telephone line and as a result were not heard by the actors in the studio. Consulting with the directors Sinton thought the players' performance would be more convincing if they could hear these background effects. So he devised a turntable and phonograph pickup, with an associated amplifier and reproducer which would enable his sound discs to produce the desired effect in the studio and feed them to the transcription disc only via the studio microphone in the hearing of the cast.

At present Sinton is engaged in a fascinating task assigned to him by the W. B. S. which is sending him to various sections of New York and its environs in a car equipped with electrical transcribing apparatus. The purpose of these trips is to capture at first hand harbor noises, subway sounds, the rumble of freight cars, the blast of steam shovels, steel drills and all of the noisesome background familiar to Manhattan.

(See also the very interesting article, "How the Robot Fools You," in the April, 1932, issue of EVERYDAY SCIENCE AND MECHANICS, pg. 410. *Technical Editor.*)

A "Talking Fiddle"

A New York musician has devised a sound amplification system which he claims will produce the effect of a full symphony orchestra, although a number of string instruments are eliminated.

Instead of utilizing the usual large number of first and second violins, only two first and two second violins are employed. Each violin is equipped with a Universal model W watch-case type microphone, attached to the bridge of the instrument.

In addition two large model LL Universal microphones are used to pick up the orchestra as a unit. Only a single amplifier is necessary. The number of speakers, as well as their arrangement, is determined by the acoustical conditions of the auditorium.

There is a mixer between the microphone and the amplifier, which permits separate volume control for each of the six microphones. In this way, the volume of the four violins may be amplified above that of the other instruments, to as great an extent as desired.

Using this plan, the orchestra is under the direction of a leader who directs the musicians and also controls the mixing panel, increasing the volume of the first and second violins as compared to that of the other instruments, to give the effect of a complete symphony orchestra and also to suit his individual interpretation of the way in which the selection should sound. Modifications of the above plan have been suggested, whereby additional microphones could be used in connection with the reproduction of other instrument sounds.

(See also "The Radio Violin" in the December, 1931, issue of RADIO-CRAFT, pg. 358. *Technical Editor.*)

A "Padded Cell" for Sound Tests

In the general Engineering laboratory of the General Electric Company at Schenectady there is a padded cell—a room, within a room, of such construction that outside sounds, and even building rumble, cannot enter.

The outer wall is of sound-absorbing plaster; next within is hollow tile; then an air space; felt; another wall of sound-absorbing plaster; more air space; sheet iron; air space; lath-work, and then a thick layer of cotton waste—with a total thickness of about 18 inches. The ceiling of the inner room is similarly constructed; and the floor is supported on a felt blanket. Heavily padded double doors isolate the room.

Within the room—where lack of reflections causes one's voice to sound strange—are conducted experiments to determine the amount and type of noise produced by motors, fans, and many other kinds of equipment. The measurements are made with a noise meter which is a product of the same laboratory.

SCOTT TAKES 20,000-MILE CRUISE TO GIVE RADIO ANOTHER HARD TEST

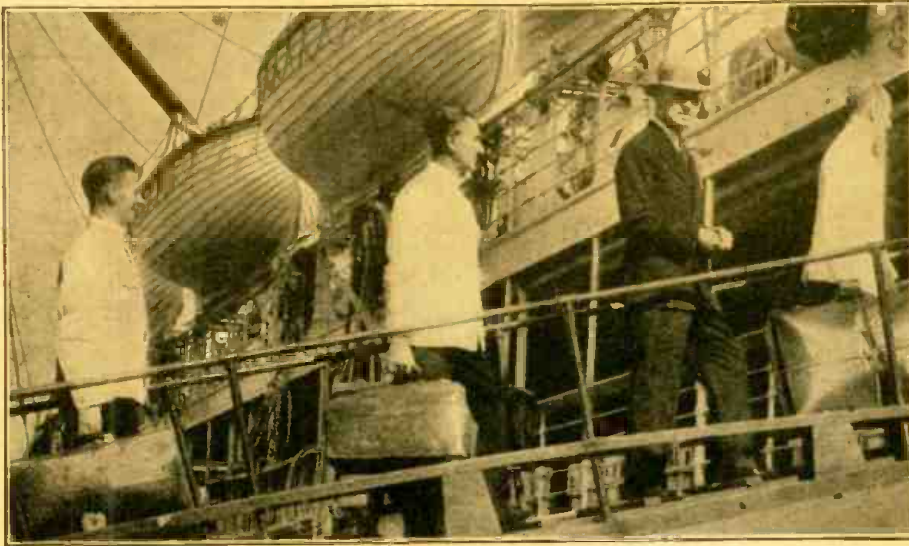

E. H. Scott, designer and builder of the famous Radio Receiver bearing his name, boards the SS. Maunganui to start 20,000-mile cruise.

WORLD-WIDE RECEPTION GUARANTEE BASED ON CONSISTENT PERFORMANCE

Backing the Scott All-Wave Deluxe Radio with a positive guarantee of consistent world-wide reception, with loud speaker volume, of foreign stations 10,000 miles or more distant, was not justified by scientific laboratory tests alone. Rather such tests, under actual owner-operated conditions, as the reception in Chicago of every program broadcast from VK2ME and VK3ME in Australia (9,500 miles distant) throughout an entire year's time, were considered more conclusive. Likewise were the more than 19,000 verified foreign reception logs submitted by Scott owners within a six months' period contributory to the

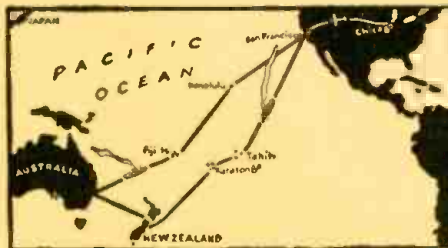

Here is the route of E. H. Scott's long cruise, undertaken to test reception under most difficult conditions.

WORLD-TRAVELING RECEIVER

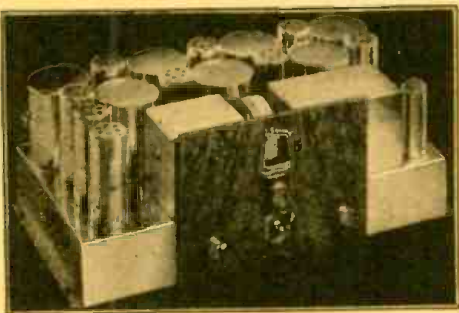

This Scott All-Wave Deluxe Radio which Mr. Scott is using on his research trip is an exact duplicate of the custom-built sets sold to discriminating buyers. It receives broadcasts on all wave lengths between 15 and 550 meters. Of true one-dial type, it uses no trimmers or auxiliary tuning dials, and has no plug-in or tapped coils or other old-fashioned wave band-changing devices. It is equipped with automatic volume control, visual tuning, static reducer, and every new scientific betterment of proved value. Despite its tremendous distance range, high selectivity, absolutely natural tone, and general excellence, it is sold at a remarkably moderate price.

maker's decision to back his receiver with such a startling warranty. On his present 20,000-mile experimental cruise Mr. Scott will cover many localities where radio reception is extremely difficult. He is wholly confident that even in these so-called "dead spots" his set will function perfectly for him as it is doing for many owners in places where radio reception was always before considered impossible.

ENTHUSIASTIC OWNERS CONTINUE TO LAUD PERFORMANCE OF ALL-WAVE DELUXE

Letters expressing perfect satisfaction with the marvelous Scott All-Wave Deluxe Radio pour into the Scott Laboratories daily. Here are excerpts from a few recent ones: "Most sensitive radio I have ever seen," SGP, Ala. . . . "Nothing finer in tone—in fact, perfect in every way," FW, Calif. . . . "Stations all the way from Berlin to Tokio and Australia," . . . JBT, Conn. . . . "Foreign reception every day. France best—Rome, England, Germany and Spain come in very good," RPH, Conn. . . . "Tone cannot be improved—it is already perfect," GL, N. Y. . . . "Australia with the volume of a local station," Dr. HPC, N. Y. . . . "Amazed at results—would not take \$500 in exchange for it," JLH, Pa. If you would

Research To Prove Perfection Of Scott All-Wave Deluxe

E. H. Scott, whose genius created the marvelous SCOTT ALL-WAVE DELUXE RADIO, sailed recently on an adventurous 20,000-mile voyage to give his receiver still another series of gruelling reception tests.

Thousands of miles from any land the SS. Maunganui plows her way down the trackless Pacific enroute to New Zealand. Her passengers are gay as they gather in the luxurious Grand Salon each evening. They enjoy an excellent dance orchestra's rhythms. The tunes come from a loud-speaker that reproduces the music of orchestras six or seven thousand miles away, back in "the States."



E. H. SCOTT

To E. H. Scott, and the world's-record-shattering receiver which he designed and builds, must go all the credit for this exceptional feat. But bringing music, daily news flashes and other radio treats to the Maunganui's company is but a small part of the thorough research Mr. Scott is carrying on during his cruise to test his receiver. From his experimentation with the Scott All-Wave Deluxe, which is his most important piece of baggage, will come new inspiration and still further justification of the consistent world-wide reception guarantee under which this radio known as "The World's Finest Receiver" is sold.

The radio-wise will watch with interest for final reports of Mr. Scott's research. They confidently expect news of the breaking of still more reception records as one outgrowth of this long trek.

like such a set—the ultimate in radio ability—why not send NOW for all details regarding it?

SEND COUPON AT ONCE!

E. H. SCOTT RADIO LABORATORIES, INC.
4450 Ravenswood Ave., Dept. C-53, Chicago, Ill.

Send me all details regarding the SCOTT ALL-WAVE DELUXE RADIO, including technical data, performance proofs and prices. This is not to obligate me.

Name

Address

Town..... State.....

5. **CLAROSTAT CONTROL HANDBOOK.** A large 32-page book containing detailed specifications of volume controls, attenuators, constant-impedance controls, phonograph pickup faders, tone controls, line ballasts, rheostats, potentiometers and fixed resistors of various kinds, together with valuable circuit-design data. Contains many diagrams and charts, and a guide of replacement volume and tone controls for many commercial receivers. *Clarostat Manufacturing Company, Inc.*

6. **MEASURING RESISTANCE BY THE DEFLECTION METHOD.** The conventional method for the measurement of resistance involves the use of the Wheatstone bridge, a costly piece of apparatus. However, there are other methods which provide a fair degree of accuracy, enough for all practical purposes. The least expensive is the deflection method, which makes use of popularly priced milliammeters and fixed resistors. This bulletin describes the method completely, and should be very useful to Service Men and experimenters with limited meter equipment. *Shallcross Manufacturing Company.*

11. **SUPREME INSTRUMENTS.** Contains lengthy descriptions of the Supreme service instruments, including the AAA1 Diagonometer, which is five instruments in one, the model 90 analyzer, the model 40 tube tester and the models 60 and 70 oscillators. Interesting to the Service Man because it tells how his work is facilitated by ingeniously-designed test equipment that indicates the condition of an entire set in a few minutes. New test apparatus to take care of the new tubes is also described. *Supreme Instrument Corporation.*

19. **A BAPTISM OF FIRE.** Centralab fixed resistors are made by forcing a carefully calibrated resistance material through a plastic ceramic material, and then baking both under terrific heat. This booklet describes the manufacturing process in detail, and lists the advantages claimed for fixed resistors of this type. It is interestingly written and illustrated, and makes good reading. *Central Radio Laboratories, Inc.*

21. **READRITE RADIO INSTRUMENTS.** This sixteen-page pamphlet contains some valuable hints on the testing of electrolytic condensers, as well as descriptions of the full line of popular-priced Readrite instruments. Worth having. *Readrite Meter Works.*

22. **HOW TO TEST PENTODES.** This is a reprint of an article of the same name that appeared in the September, 1931, number of RADIO-CRAFT, accompanied by descriptive matter on the adapters specified for the purpose. If you missed the original article study the reprint; it contains much useful data for owners of testers or analyzers not already equipped to test pentodes. *Alden Manufacturing Company.*

76. **THE COAST-TO-COAST "BROADCAST."** The "Broadcast" is the Fall 1932 edition of a 100-page mail order catalog that is a veritable encyclopedia. Its listings are very varied, and run from soldering lugs to complete 100-watt public address amplifiers. Every article is well illustrated and described for the benefit of radio

READERS' BUREAU

On this page are listed manufacturers' catalogs and booklets, chosen because they are of interest to readers of RADIO CRAFT. Many of them contain valuable technical data in the form of charts, curves, tables, etc., and are therefore worth having and saving. You can obtain copies FREE by using the coupon below.

dealers and Service Men, for whom the volume is specifically intended.

A large amount of space is also given to replacement power transformers, condensers and resistors for ordinary service work. This catalog is well prepared and is worth saving. *Coast-to-Coast Radio Corporation.*

81. **I. R. C. RESISTOR CATALOG.** This sixteen-page catalog describes a very complete line of fixed resistors for radio purposes. It includes full performance characteristics, so that a Service Man or an experimenter with a particular requirement in mind can select exactly the right unit for his purpose. A section in the back contains valuable data on the conversion of milliammeters into ohmmeters and voltmeters, and on the extension of voltmeter and ammeter ranges. This catalog is well worth saving. *International Resistance Company.*

93. **DUBILIER CONDENSERS.** The 1933 catalog of Dubilier condensers is a large 16-page booklet describing fixed condensers for every conceivable application. These range from little mica units for receiving circuits to man-high assemblies for transmitting work. A useful catalog to all radio men. *Dubilier Condenser Corporation.*

94. **ELECTRAD PRODUCTS.** The newest and latest catalog of Electrad products contains twelve pages and lists many types of fixed and variable resistors and five different kinds of amplifiers for public address purposes. The popular Truvolt resistors have been improved by the addition of insulating shields and heat radiating covers, and a number of new sizes have been added to the line. The catalog also contains some valuable data on the application of resistors to radio receivers, transmitters, amplifiers and sound systems, and suggestions on how to compute the value of resistors. A handy and useful catalog. *Electrad, Inc.*

95. **CARDWELL CONDENSERS.** This is a condensed four-page catalog of the well known Cardwell "Midway" variable condensers for transmitting and receiving. These are small but not "midget" size instruments designed for purposes where extremely light weight and reduction of bulk are desirable. Complete and detailed specifications are included for the assistance of constructors. *Allan D. Cardwell Mfg. Corp.*

96. **TOBE FILTERIZER AND CONDENSERS.** The Tobe Deutschmann company is now catering to the Service Man with an extensive line of filter, by-pass and line condensers and radio noise eliminators. Their latest catalog, describing the complete line, has just come off the press. A full page is given to the new "Filterizer" noise eliminating antenna system, an item of particular interest to Service Men because of the money-making opportunities it offers. *Tobe Deutschmann Corporation.*

97. **ARCO TUBE BULLETIN.** A descriptive folder giving full technical characteristics on the complete line of Arco radio receiving and transmitting tubes, photo-electric cells, television lamps, hot and cold cathode tubes, cathode ray tubes, rectifiers and charger bulbs. This can be posted for easy reference. *Arco Tube Company.*

98. **HOW TO USE NOISE REDUCING ANTENNA SYSTEM ON BROADCAST WAVES AND SHORT WAVES** is the title of the latest booklet on this important subject. In addition to covering the theory, the practical application of the various noise-reducing systems available for broadcast and short wave use, is described also. *Lynch Mfg. Co.*

99. **AMPERITE CHART.** Service Men will find this chart very valuable, as it shows the correct Amperite line voltage regulator to use with any of several hundred different broadcast receivers. An accompanying pamphlet explains how overloaded condensers and resistors may be the cause of crackling noises and poor reception. *Amperite Corporation.*

100. **WHOLESALE RADIO SERVICE CATALOG.** The new Spring 1933 Wholesale Radio catalog contains 152 pages, and is probably the largest mail order catalog of its kind in print. It is exceptionally complete, and includes everything from soldering lugs to all-wave receivers. It is of value to dealers, Service Men and experimenters for reference and ordering purposes. *Wholesale Radio Service Co. Inc.*

RADIO-CRAFT 5-100

Readers Bureau
96-98 Park Place, New York, N. Y.

Please send me free of charge the following booklets indicated by numbers in the published list above:

No.

Name

Address

City State.....

(Please check the following)

I am

(1) Service Man (2) Experimenter

(3) Dealer (4) Jobber

(5) Radio Engineer

(6) Licensed Amateur

(7) Professional or Amateur Set

Builder

This coupon will not be honored unless you

check off your classification above.



BE A RADIO EXPERT

Many Make **\$50 to \$100** a Week

I'll Train You at Home in Your Spare Time
for **RADIO · TELEVISION · TALKING MOVIES**

J. E. Smith, President, National Radio Institute, the man who has directed the Home-Study training of more men for the Radio Industry than any other man in America.

	<p>Set Servicing Spare-time set servicing has paid many N. R. I. men \$200 to \$1,000 a year. Full-time men make as much as \$65, \$75, and \$100 a week.</p>		<p>Broadcasting Stations Employ trained men continually for jobs paying as much as \$5,000 a year.</p>		<p>Ship Operating Radio operators on ships see the world free and get good pay plus expenses. Here's one enjoying shore leave.</p>
--	--	--	---	--	---

Aircraft Radio
Radio is making flying safer. Radio operators employed through Civil Service Commission earn \$1,620 to \$2,800 a year.

IF you are dissatisfied with your present job, if you are struggling along in a rut with little or no prospect of anything better than a skinny pay envelope—clip the coupon NOW. Get my big FREE book on the opportunities in Radio. Read how quickly you can learn at home in your spare time to be a Radio Expert—what good jobs my graduates have been getting—real jobs with real futures.

Many Make \$5, \$10, \$15 a Week Extra in Spare Time Almost at Once

The day you enroll with me I send you instructions which you should master quickly for doing 28 jobs common in most every neighborhood, for spare-time money. Throughout your course I send you information on servicing popular makes of sets! I give you the plans and ideas that have made \$200 to \$1,000 a year for N. R. I. men in their spare time. My course is famous as the course that pays for itself.

Many Radio Experts Make \$50 to \$100 a Week
In about ten years the Radio Industry has grown from \$2,000,000 to hundreds of millions of dollars. Over 300,000 jobs have been created by this growth, and thousands more will be created by its continued development. Many men and young men with the right training—the kind of training I give you in the N. R. I. course—have stepped into Radio at two and three times their former salaries.

Talking Movies, Television, Short Wave, Money-Back Agreement Included

Special training in Talking Movies, Television and Home Television experiments, Short Wave Radio, Radio's use in Aviation, Servicing and Merchandising Sets, Broadcasting, Commercial and Ship Stations are included. I am so sure that N. R. I. can train you satisfactorily that I will agree in writing to refund every penny of your tuition if you are not satisfied with my Lesson and Instruction Service upon completion.

Talking Movies
An invention made possible by Radio. Employs many well trained Radio men for jobs paying \$75 to \$200 a week.

Get Ready Now for Jobs Like These

Broadcasting stations use engineers, operators, station managers, and pay up to \$5,000 a year. Manufacturers continually employ testers, inspectors, foremen, engineers, service men, buyers, for jobs paying up to \$6,000 a year. Radio Operators on ships enjoy life, see the world, with board and lodging free, and get good pay besides. Dealers and jobbers employ service men, salesmen, buyers, managers, and pay up to \$100 a week. My book tells you about these and many other kinds of interesting Radio jobs.

64-page Book of Information FREE

Get your copy today. It's free to all residents of the United States and Canada over 15 years old. It tells you where Radio's good jobs are, what they pay, tells you about my course, what others who have taken it are doing and making. Find out what Radio offers you without the slightest obligation. **ACT NOW!**



SPECIAL Radio Equipment for Broad Practical Experience Given Without Extra Charge

My course is not all theory. I'll show you how to use my special Radio Equipment for conducting experiments and building circuits which illustrate important principles used in such well known sets as Westinghouse, General Electric, Philco, R. C. A., Victor, Majestic, and others. You work out with your own hands many of the things you read in our lesson books. This 50-50 method of training makes learning at home easy, interesting, fascinating, intensely practical. You learn how sets work, why they work, how to make them work when they are out of order. Training like this shows up in your pay envelope—when you graduate you have had training and experience—you're not simply looking for a job where you can get experience.

THIS COUPON IS GOOD for One FREE COPY OF MY BOOK *mail it now*

J. E. SMITH, President
National Radio Institute, Dept. 3EX
Washington, D. C.

Without obligating me, send free book about spare-time and full-time Radio opportunities and how I can train for them at home.

Name..... Age.....
Address.....
City..... State.....



Television
The coming field of many great opportunities is covered by my course.

This

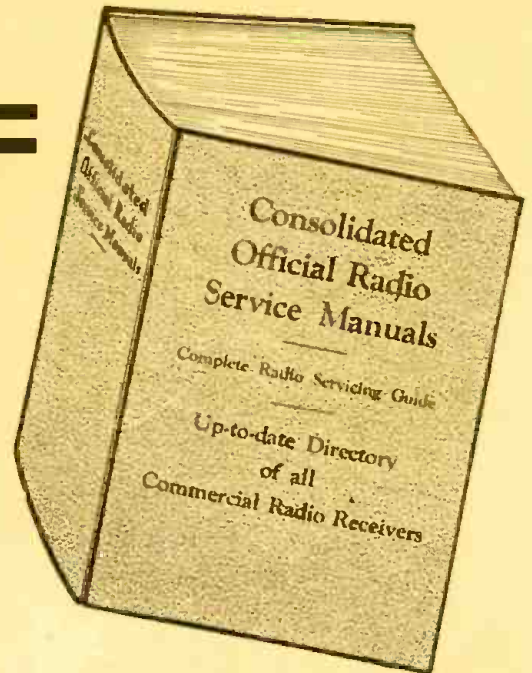

Radio's GREATEST Servicing Book

The Most Complete Directory of Radio Circuit Diagrams published!

**In ONE VOLUME of over 2,300 Pages
Extra Heavy Cover—Looseleaf Bound**

Buy this Big Volume on our *New*

DEFERRED PAYMENT PLAN

Here are two of the most surprising announcements that we have ever made to the radio trade and we know that it is such good news that every radio man will be greatly enthused.

FIRST—that the three editions of the OFFICIAL RADIO SERVICE MANUALS have now been combined into one big volume of over 2,300 pages.

SECOND—that this new single volume of consolidated radio circuit diagrams and complete radio servicing course can be bought on a deferred payment plan—and at a big saving.

It is needless to say how valuable the OFFICIAL RADIO SERVICE MANUALS have been to members in every branch of the Radio Industry, and how many thousands of each edition have been sold to manufacturers, jobbers, dealers, Service Men and experimenters. But we must emphasize this one fact: Service Men now realize that they are tremendously handicapped without the full set of Gernsback Manuals. So much so, that those who have purchased only one or two volumes, are NOW ORDERING THE MISSING BOOKS. They want their files to be complete.

The complete book gives you a volume of over 2,300 pages with over 5,500 diagrams, charts and photos. There are absolutely no pages or illustrations or diagrams duplicated. There is no radio book published today which is so modern, up-to-the-minute, and which contains so much useful information as is to be found in this single volume. It is a book that will outlast any other radio book in print. Look carefully at the illustration of the complete edition on the top of page. It measures 9" wide, 12" long, 4½" thick.

Included in this volume is a complete radio servicing course. This course covers every step needed to learn the servicing business . . . from starting in business . . . materials needed . . . and how to go about servicing receivers and repairing other radio equipment. This course in itself, is actually worth the price of the entire book.

Our new plan now enables every radio man to get this single volume—a Complete Directory of all Circuit Diagrams, of over 2,300 pages, on deferred payments. You can order this book immediately—get it in a few days, and use it while you are doing servicing work. You can make the first few calls pay for the entire cost of the book.

For you to get this book is quite simple and it is sent to you as soon as your order is received. You pay for it in small monthly amounts which can be taken from your earnings. If you were to buy the three volumes separately, the total cost would be \$17.00, including the supplements.

Now you can get the
1931 OFFICIAL RADIO SERVICE MANUAL, with Supplements,
1932 OFFICIAL RADIO SERVICE MANUAL, with Supplements,
and the 1933 OFFICIAL RADIO SERVICE MANUAL Complete

at a big saving.
THE SPECIAL NEW PRICE FOR ALL THREE MANUALS, WITH SUPPLEMENTS, IN ONE VOLUME, WITH HEAVY BINDER IS ONLY

\$14.00

You buy this book this way—
Send \$3.00 with order—
Pay \$5.00 to Express Company upon receipt of book.

Send \$3.00 thirty days after receipt of book.
Send \$3.00 sixty days after receipt of book.
Total \$14.00.

IF THE ENTIRE AMOUNT IS SENT WITH YOUR ORDER, WE WILL ALLOW YOU A 10% DISCOUNT. THIS CAN BE DEDUCTED FROM YOUR REMITTANCE.

IMMEDIATE SHIPMENT

Mail Coupon Today!

GERNSBACK PUBLICATIONS, Inc.,
96-98 Park Place, New York, N. Y.

Gentlemen:
In accordance with your Special Offer, I enclose herewith \$3.00 as first payment toward the One-Volume Radio Manual. Please forward it to me promptly. Upon receipt of the book, I shall pay express company \$5.00. Thirty days later I shall send you \$3.00, and sixty days after receipt of book, I shall send you my last payment of \$3.00. If you want to take advantage of the Special Discount of 10%, remit only \$12.60 with this coupon.

Name

Address

City State RC-533

OVER 2,300 Pages 5,500 Illustrations

THIS IS THE GREATEST SINGLE VOLUME RADIO BOOK IN PRINT TODAY

GERNSBACK PUBLICATIONS, Inc.

96-98 Park Place

New York, N. Y.



"Takes the Resistance Out of Radio"

Editorial Offices: 96-98 Park Place, New York, N. Y.

HUGO GERNSBACK, Editor

Vol. IV, No. 11, May, 1933

DX LISTENING

An Editorial by HUGO GERNSBACK

AS I HAVE often remarked before, radio has always moved in cycles. Everything that is connected with radio moves in an endless cycle. When broadcasting first became popular, there developed a great itch for "DX" listening. (For the benefit of newcomers, the initials "DX" are an abbreviation, used originally for code purposes, and meaning "long distance.") When people were building their own sets, in the early '20's, the favorite pastime was a one-tube set with which you could listen to stations hundreds of miles away. People used to sit up all night trying to get the distant stations. Then, at the end of the '20's, the DX interest lagged somewhat, and by 1930 it seemed to have completely died down, except for a few professionals who kept at it with unabated vigor.

Of late, when people have again become more sane, and are staying at home more than formerly, the "DX bug" seems to have infected a large part of the community once more; once again editors of radio publications are beginning to be flooded with DX accomplishments which, this time, are of no mean order. A few hundred paltry miles are no longer of any interest. Your present DX listeners, and I am now speaking of broadcast listeners only, are going out for REAL distance. Listening from one end of the country to the other means nothing. Middle-Western listeners have actually been able to pull in stations from Australia on normal broadcast waves; and a number of other Eastern listeners receive European broadcasts, as well as those of other countries, such as Central America, and even South America, regularly.

This might strike one as impossible at first, but there are several good reasons for this: first and foremost, we are now in the favorable position of a sunspot cycle, which aids radio reception. This cycle is now decreasing, and will reach its minimum, indicating favorable reception, in 1934. It will then *gradually* increase and decrease again and, by 1945, will be at another minimum. It is, therefore, possible to look forward towards better radio reception both for broadcast wavelengths as well as short-wave reception, during the next few years.

Of course, not every radio set will bring in broadcast stations from the Antipodes. You must first have a good radio location; you must have a powerful set; and you must choose your hours for listening accordingly. The large cities, as a rule, cluttered up with broadcast stations, are not favorable for DX listening when it comes to real distance; although there are exceptions to this rule. Just what is the best set, is also not quite clear; for sometimes a set with only a few tubes seems to perform as well as another set with ten or twelve tubes, which may not even work well at all. Of course, an excellent aerial and ground are the first requisites; and, then too, the set must work at its maximum sensitivity if real results are to be expected.

On the short waves, DX listening is, of course, commonplace; because a good two-tube set will bring in stations from the maximum distance on this planet, *i.e.*, 12,500 miles; and these records are so common that every school-boy in the United States today who owns a short-wave set

thinks nothing of listening to stations in Australia and other parts of the world.

The main remarks in this article, however, refer to broadcast listeners on the broadcast wavelength from 200 to 545 meters, and there are, therefore, still a great many worlds to conquer and thrills to get. The mere fact that it is difficult to get reception from really great distances on broadcast sets makes the sport all the more exciting.

The rule of the game seems to be that the ordinary commercial set, generally, is not suitable for extreme distance reception; but there are notable exceptions to this rule. Some of the very fine high-priced commercial sets have been able to bring in real distance. As a rule, only really high-class, custom-built jobs, and those sets built especially with a view to bringing in distance—usually of the super-heterodyne type—seem to get the best results for their owners. The reason, of course, is that all the circuits must be peaked to their resonant frequencies, and the entire set must work with maximum efficiency. The least unbalancing will make a set unsuitable for really great distance work. Some of the best manufactured sets on the market may normally get stations from 1,000 to 2,000 miles without any trouble, but will fall down when receiving stations over 5,000 miles away.

Remember particularly, that the problem is somewhat difficult, because there are available only 96 broadcast channels on which there are thousands of stations. Even if you get the broadcast-carrier frequency from a station 5,000 miles distant on your special set, the chances are that you will not be able to identify the call letters; because a half a dozen foreign stations may be camping on the same wavelength at the same time. The trick, therefore, is to pick out a time when most of the stations have gone off the air; you will then be enabled to listen to the one station you are after.

Naturally, you are not going to do all this in a single evening. It takes many months of patient work; and then you must get verifications from the stations themselves to prove that you are right.

The DX interest by the public at the present time is of more than passing interest to the Service Man, too. The more owners are using their sets, the better it is for the servicing fraternity. Many Service Men today are making extra money by sending circulars to their customers calling attention to the fact that, by overhauling their sets, they may be enabled to listen to stations thousands of miles away. This gives a new incentive to owners, and many have become addicts to DX listening after they have been shown how to do it.

To be sure, not every commercial set will do it immediately. Aerial changes are often necessary. The set may have to be recompensated, condensers lined up, and sometimes structural changes effected to make the set work at its highest efficiency. If the Service Man is able to show the owner that his former set can now bring in stations a few thousand miles away, the customer will be glad to pay the charges, which should not be unreasonably high.

HOW TO BUILD THE "RADIOLAMP" TABLE RECEIVER

This article describes the construction of a miniature radio set combined with a table lamp—the lamp serves as the limiting resistor in the filament circuit.

CLYDE FITCH

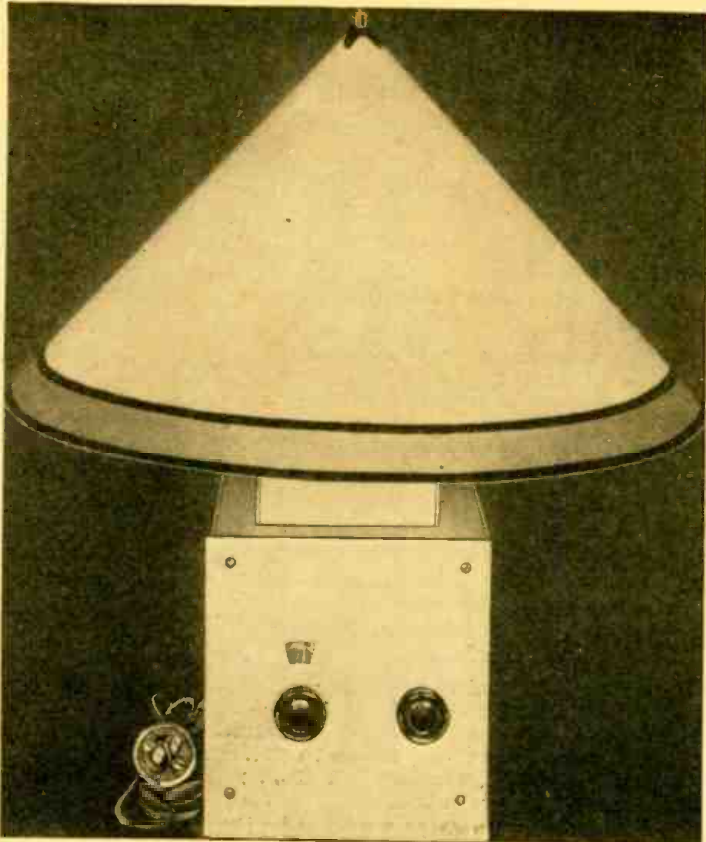

Fig. A

Front view of the Radiolamp ready for operation. Looks interesting, eh? Well, it is interesting.

As stated in a previous issue, this publication is sponsoring a drive for better and more novel cabinet design. The receiver described by Mr. Fitch is an example of what we mean. It is a combination reading lamp and radio set; the idea is simple, but for some strange reason has never been produced commercially. The circuit is standard, and should give no trouble to the average set builder.

IN THE February, 1933 issue of RADIO-CRAFT there appeared the first complete description of one of the new miniature radio receivers. It seems as though, overnight, this type of set has earned its spurs, and has swept the country by storm. It not only fills a great public need, but, to the ingenious radio fan, it offers unlimited possibilities for home-made sets of novel design. For example, the "Radiolamp," illustrated herewith, was made possible by following the general principles of miniature set construction and combining them with a lamp. Also, the variety of new tubes now available, mainly the 6-volt, .3-ampere automobile type, which is used in this set, makes possible many interesting set combinations for the home constructor.

The Radiolamp, see Fig. 1, contains three tubes and a rectifier. The first tube is a type 39, R.F. pentode amplifier, coupled to a type 36 screen-grid detector, which is, in turn, resistance coupled to a type 38 output pentode. The rectifier is a type 12Z3. All of the tubes except the rectifier have a 6.3-volt heater which operates at .3-ampere. The rectifier has a 12-volt filament also rated at .3-ampere. This tube has an indirectly heated cathode, and, although of the high-vacuum type, it has a low internal voltage drop, which does not cause any appreciable reduction in voltage available for the plates of the tubes.

Miniature radio sets are made universal; that is, they operate on both A.C. and D. C. The filaments of the tubes are connected in series and are connected directly to the 110-volt line through a limiting resistor, thus avoiding the use of filament transformers. The limiting resistor causes a voltage drop of some 85 volts, and, consequently, at .3-ampere, it must dissipate about 25 watts of electrical energy in the form of heat. For this reason many miniature

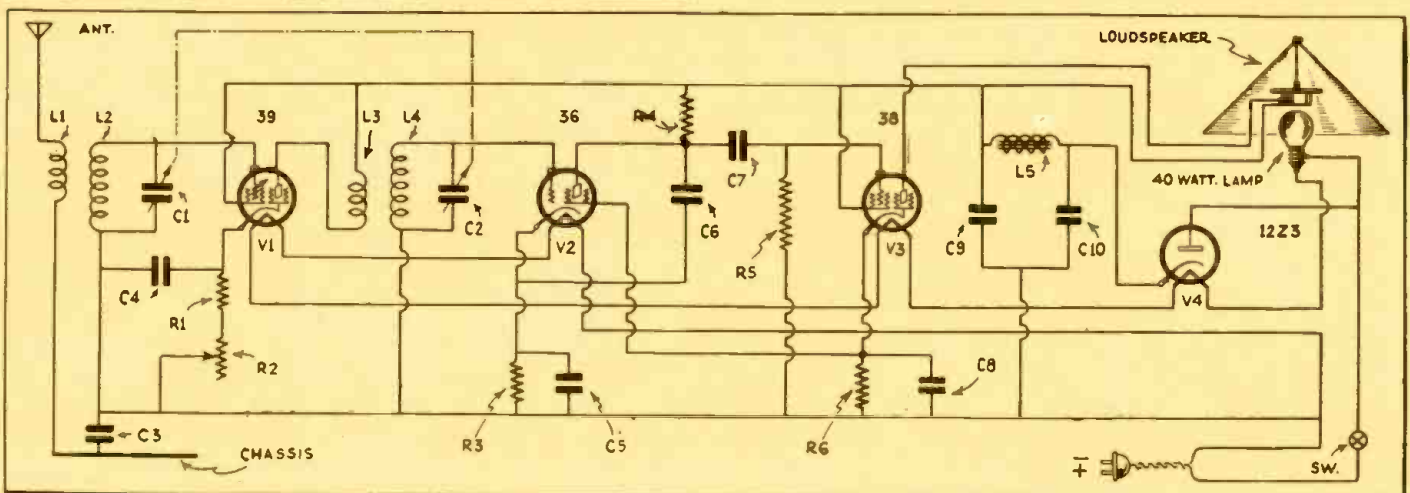

Fig. 1

Schematic circuit of the receiver. Note its similarity to the International Kadette. SW. and R2 are gaged.

sets get hot enough to fry eggs on! This condition is one important reason why the combined set and table lamp is a logical combination, as the limiting resistor is eliminated and the lamp bulb takes its place, thus converting energy which was formerly wasted, into useful light.

A table lamp requires a shade. By making the lamp of modern design, the shade may be in the shape of a cone, thus making it suitable to serve as a loudspeaker diaphragm. Without the limiting resistor and the loudspeaker in the set, the set itself can be made smaller, so that there will be ample room in the base of the lamp for the set without making the base unduly large.

Another important reason for combining the set and lamp is that a much larger cone can be used than is ordinarily used in a miniature set, and the tone quality is thereby considerably improved.

The Radio Chassis

Figure 1 shows the schematic diagram of the receiver. The circuit is conventional and is typical of the type used in many commercial miniature sets. It is a simple set to wire, and one should have no difficulty in making the connections. One point to observe is that the type 36 detector heater is connected to the negative side of the line, assuming the set is plugged into a D.C. outlet. This is important in order to reduce hum to a minimum when the set is used on an A.C. line. From the negative side of the line the current passes through the detector heater, then the type 39 R.F. tube heater, into the type 38 A.F. tube heater, and through the rectifier tube filament into the lamp filament and back through the switch to the other side of the 110-volt line. A 40-watt Mazda lamp is the correct size to use with this set.

We can also trace the plate supply from one side of the line through the switch to the rectifier plate, out through the cathode of the rectifier to the filter choke L5, and on to the other tubes. About 95 volts are available for operating these tubes, whether used with an A.C. or a D.C. light-line supply.

Another point to observe is that the screen of the detector tube is connected to the cathode of the type 38 tube so that a positive potential is obtained for the screen which is equal to the grid bias of the type 38 tube.

All of the parts are marked in the diagram with the same symbols as used in the other illustrations and in the List of Parts. Note that the metal chassis is insulated from all of the wiring by means of the insulating condenser C3. This procedure is followed to avoid any possibility of a short circuit or serious shock should the metal chassis become grounded accidentally, as usually one side of the light line is grounded, and the negative "B" supply is connected directly to one side of the line. For this reason it is important, in mounting the two-gang tuning condenser, C1 and C2, and the electrolytic filter condensers C9 and C10, to use insulating bakelite washers under the screws and make sure that the mounting screws do not touch the metal chassis. The volume control, R2, is mounted on a bakelite support for the same reason. For the values of the parts, the reader should refer to the List of Parts. For the locations, the photographic illustrations, mainly Figs. C and D, should be observed.

The metal chassis and lamp frame-work are clearly illustrated in Figs. 2 and B. Fig. 3 shows a plan view of the radio chassis with the location of the holes for the tube sockets indicated. One sixteenth-inch aluminum shield can material is used throughout. All of the important dimensions and other information are given in Fig. 2. Note that the holes in the top and bottom part of the lamp base, the bottom of which is also the radio chassis, are threaded so that the sides, front, and back plates may be removed easily. The top of the lamp base is made exactly the same size as the radio chassis, or bottom. The small chassis mounted on top helps support the two rods which support the loudspeaker unit and the wire frame for the shade and, also, improves the general appearance of the lamp.

The "Radiolamp"

The combined lamp shade and loudspeaker cone is cut from a piece of white drawing paper to the size shown in

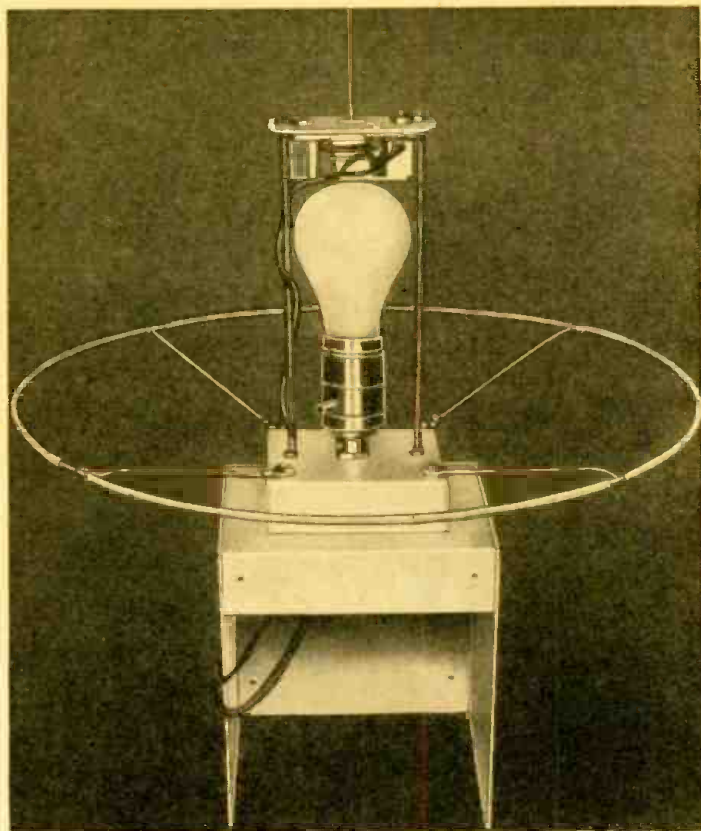

Fig. 8
View of the speaker-lamp construction with the "shade" removed.

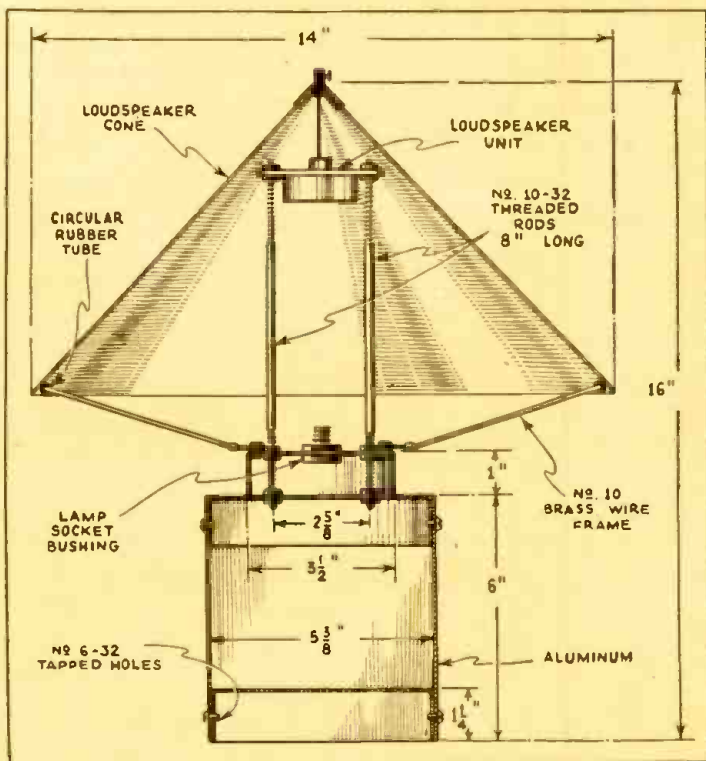

Fig. 2
Construction details of the "shade" pictured above, in Fig. 8.

Fig. 4. Ordinary lamp shade parchment should not be used as the oil it contains deadens the sound. The white drawing paper works very well for both lamp and speaker, and may be given a coat of white shellac to improve its appearance. The shellac should be applied after the border design, if any, has been painted. The design itself may be made to suit the builder's fancy. After the paper is cut out as shown in Fig. 4 and decorated and shellacked, it should

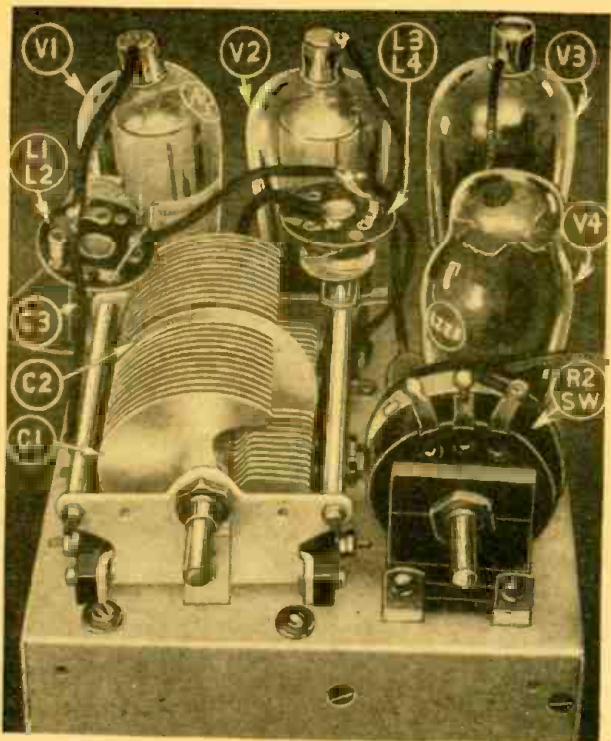

Fig C
View of the receiver with all parts labeled for convenience.

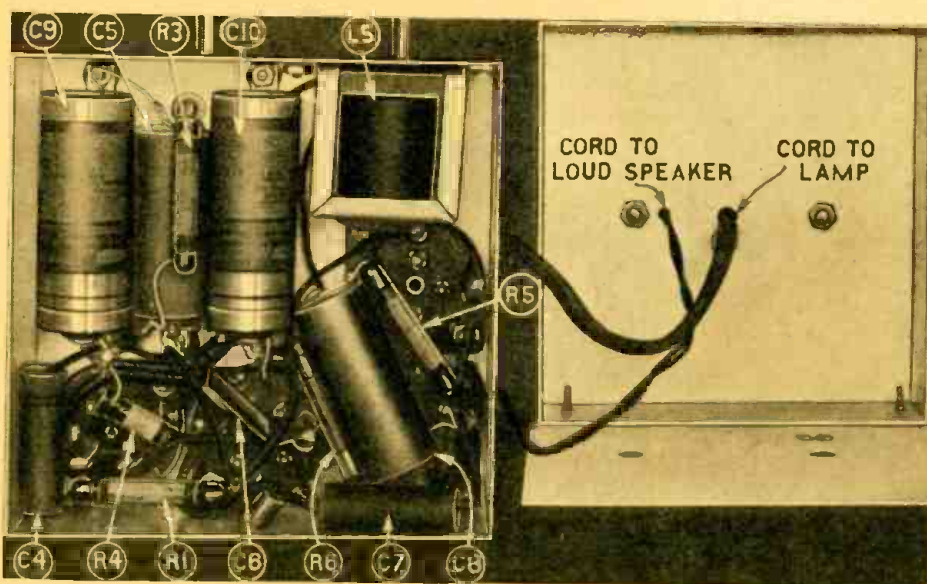

Fig. D
Under-view of the receiver and aluminum case. All values are shown.

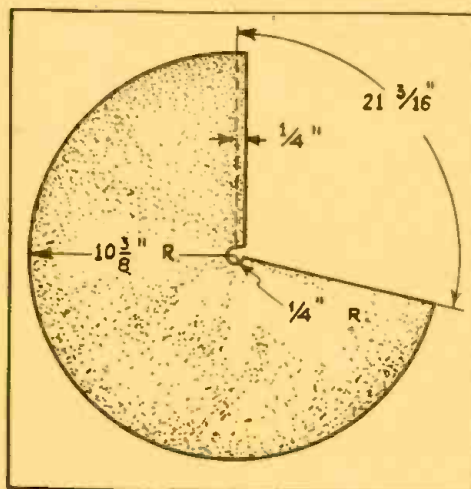

Fig. 4
Construction details for the cone-shade.

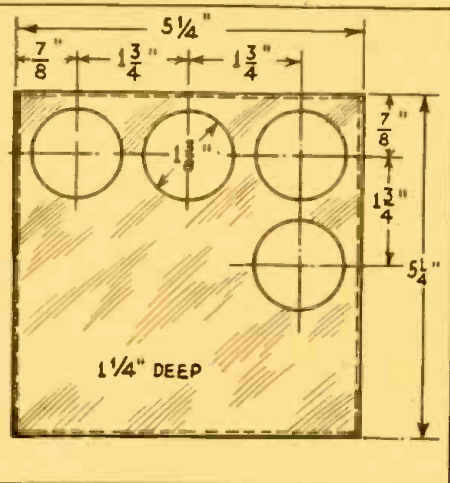

Fig. 3
Main drilling layout for the chassis.

be glued along the seam with rubber cement, forming it into a cone. The tip of the cone is clamped with metal apices similar to those used in cone-type loudspeakers. This allows it to be attached to the drive pin of the loudspeaker unit.

When assembled, the cone rests on a ring support made of No. 10 brass wire covered with a soft rubber tube. This ring is 1 3/4 inches in diameter and is supported at the lamp base in four places as shown in the photographic illustration, Fig. B. This wire support is soldered together.

The loudspeaker unit was taken from a Premier miniature cone speaker and mounted directly on the threaded rods as shown, using the mounting holes already in the unit. The drive pin was extended to fit the new cone by soldering a longer one to it.

In assembling the complete unit, the radio chassis, of course, should be built and wired first. Two wires are run from this unit up through holes in the top to the loudspeaker, and two more run up to the lamp. A lamp cord enters the back of the chassis through which connection to the line is made. The aerial lead is attached directly to one of the coils and extends through a hole in the back.

The loudspeaker lamp shade assembly may then be mounted to the top of the lamp base and the two side pieces attached. This supports everything, and the connections to the lamp and to the unit may be made, making sure that enough slack is left in the wires so that the chassis may be removed without disconnecting them. The front can then be drilled for the volume control and tuning dial shafts, and a window cut in to show the tuning dial readings. The tuning dial is simply a celluloid dial forced onto the condenser shaft and cemented on the shaft. This touch practically completes the construction of the unit. The reader should carefully study the various illustrations and note

especially how the coils are mounted directly on the tuning condenser with small brass supports. They are mounted at right angles so as to reduce oscillation.

Operating the Set

The operation of this set is quite simple. While it may not be as selective as larger T. R. F. or superheterodyne receivers, or give the power output, it is extremely sensitive and picks up many stations with a small indoor aerial. No shielding of the tubes is shown in the illustrations. In some cases, if oscillation becomes serious, it may be advisable to place a metal shield around the detector tube and also to shield the detector control-grid lead. The condenser has a shield built in it between the two units. This feature and its small size and specially cut plates facilitate tuning considerably, making it ideal for this type of receiver. The coils also are so compact that shielding is usually not required. If a very long aerial is employed, it is advisable to connect a .0001-mf. fixed condenser in series with it.

List of Parts

- One Cardwell two-gang midget condenser .00035-mf. C1, C2;
- One Sprague fixed condenser .1-mf. C3;
- One Aerovox fixed condenser .01-mf. C4;
- One Aerovox condenser .5-mf., C5;
- One Aerovox fixed condenser, .0001-mf., C6;
- One Aerovox mica fixed condenser, .02-mf., C7;
- One Solar electrolytic condenser, 4 mf., C8;
- Two Aerovox electrolytic condensers, 4 mf., C9, C10;
- One Aerovox pig-tail resistor, 150 ohms, R1;

(Continued on page 685)

THE LATEST RADIO EQUIPMENT

ALL PURPOSE METER

RADIO SERVICE MEN will be interested in the announcement of the Westinghouse Electric & Manufacturing Company of the addition of a "universal" meter to its line of switchboard and laboratory instruments. This will be supplied with an externally mounted, factory matched "Rectox" rectifier to permit maximum flexibility of application.

The new meter is of the flush type, with a bakelite molded case measuring 3 1/2 inches in diameter and 2 7/8 inches deep. The scale has calibrations alternately colored in black and red for three D.C. voltage ranges, one resistance range, and one A.C. voltage range. By the use of multipliers and shunts, A.C. and D.C. ranges of 5, 10, 50, 100, 250 and 1000 volts, and resistance ranges of 10,000 and 100,000 ohms, may be obtained.

In order to provide for easily constructed shunts, the resistance of the meter movement itself has been made comparatively high, 80 ohms.

The sensitivity of this instrument is 1000 ohms per volt on direct current and is appreciably higher on alternating current. This permits accurate measurements of voltages in circuits where lower resistance types of meters would give erroneous readings.

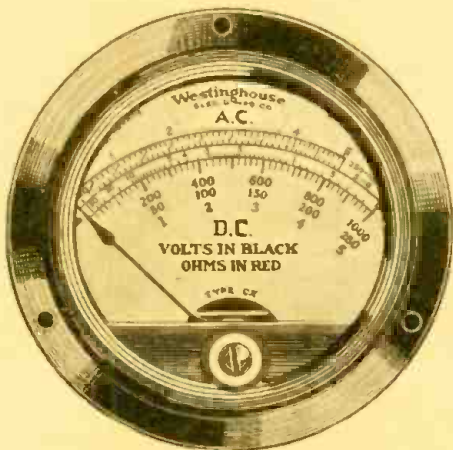

New Westinghouse "Universal" meter.

REMINGTON AUDIO AND POWER TRANSFORMERS

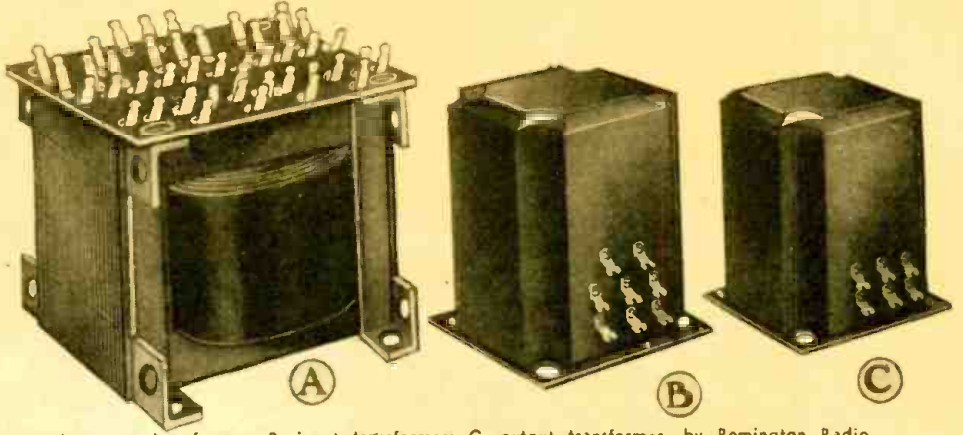

A, power transformer; B, input transformer; C, output transformer, by Remington Radio.

A NEW line of all-purpose transformers designed for experimental and laboratory purposes has been brought out by the Remington Radio & Electric Corporation.

The universal power transformer, (A in the illustration above) has a tapped primary, for 100, 112 and 125 volts, 50-60 cycles, A.C. The following high voltages are available: 900, 850, 750, 650 and 550 volts, all center tapped. The total current capacity of this winding is 125 ma. The 5% voltage regulation permits the use of this transformer in all class A, A-prime, and class B audio circuits. The following additional center-tapped secondaries are available: 5 volts, 3 amps.; 2 1/2 volts, 3 amps.; 2 1/2 volts, 12 amps.; 1 1/2 volts, 3 amps. The following filament secondaries are not

center tapped: 1 1/2 volts, 6 amps.; and 5 volts, 3 amps. Odd voltages may be obtained by connecting the various windings in series. This transformer can be used with rectifiers of the 80, 5Z5, 81, 82 and 83 types.

The universal input transformer (illustration B) is enclosed in a copper shielded, hermetically sealed iron case. Three primaries are provided, for single and double "mikes," phonograph pick-up, etc., and a single secondary for conventional connection to the input circuit of an amplifier.

The universal output transformer (illustration C) has two primaries and the equivalent of nine secondaries, and is suitable for all known types of A.F. circuits, all types of tubes and all types of speakers. These are truly versatile instruments.

CARDWELL MIDGET CONDENSERS

IN response to the demand for smaller radio parts, the Allan D. Cardwell Mfg. Corporation announces a new two-gang "Midway" featherweight variable condenser of extremely compact design. Each section has a maximum capacity of 350 mmf.

Although adequate for replacing full size receiving condensers, the new "Midway" is only slightly larger than many so-called "midget" condensers. The overall mounting space is 3 by 2 1/8 inches.

The new condenser is shown at the right in the illustration below. The accompanying condenser is a double spaced transmitting unit, 4 1/2 inches deep. The size of the "Midway" condenser may be judged by comparison.

DUBILIER CONDENSERS

The Dubilier Condenser Corporation announces a new series of pyranol impregnated high-voltage condensers for filter purposes. Cubic volume for standard capacity sizes has been reduced considerably through the use of pyranol, a patented, non-inflammable impregnator. Capacities from 1/4 to 10 mf. in voltage ratings from 5,000 to 20,000 volts available.

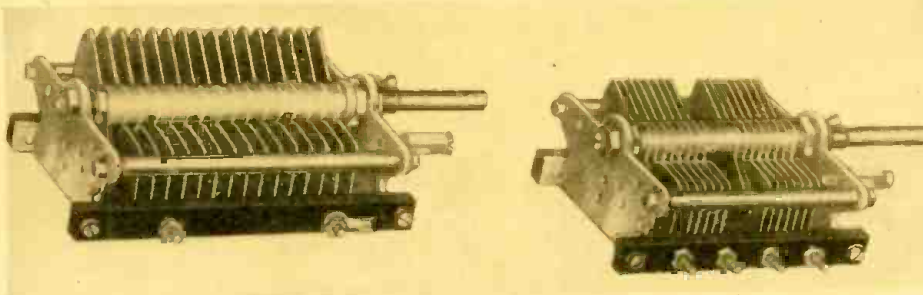

Left, Cardwell transmitting condenser; right, new "Midway" unit.

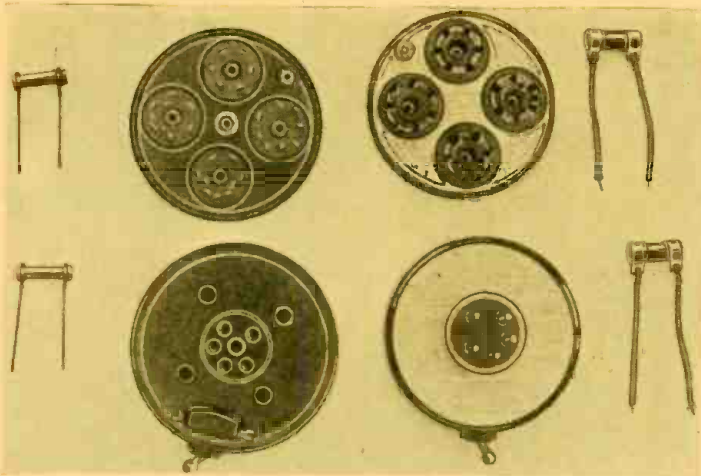

Inside and outside views of the Alden adapter and its protective resistors.

ALDEN TUBE ADAPTER

THE Alden Manufacturing Company has added several new items to its already large line of adapters for analyzers and tube checkers. Service Men owning tube checkers more than a few months old will be particularly interested in the model 95OXYL adapter, by means of which any tube checker may be brought up to date. It is very simple to operate, and there is only one toggle switch, and no plugs or jacks to bother with. It incorporates the proper resistance network to protect sensitive diodes against excessive currents as well as to safeguard delicate meter movements from the high current of mercury-vapor rectifiers. The case is of molded Makalot.

With this new adapter a total of 70 different types of tubes may be tested. There are as follows: 1, 2A5, 5Z3, 14, 15, 19, 29, 33, 36, 37, 39, 41, 42, 43, 44, 46, 47, 48, 49, 52, 55, 57, 57A, 58, 59, 64, 65, 66, 67, 68, 69, 70, 76, 77, 78, 80, 82, 83, 84, 85, 88, 89, 90, 92, 95, 98, 291, 283, 295, 985, 986, C2, C4, G2, G4, GA, KR1, KR20, KR22, KR25, KR28, LA, PA, PZ, PZH, Wunderlich, AR, AF, AG.

GOLDENTONE MIDGET

THE "GOLDENTONE" midget shown below is a product of the Fordson Radio Mfg. Corp. It is a six tube superheterodyne incorporating automatic volume control using a duplex-diode triode, tone control, "spotlight" tuning, and dynamic speaker. The intermediate frequency is 456 kilocycles.

The set is housed in an attractive cabinet measuring 16 inches high and 12 inches wide. The chassis is gold lacquered and has a distinctive appearance. The controls are conveniently located, and the scale figures are easily read.



The new Goldentone Midget super.

IN OUR JUNE ISSUE

● In the Spring, the radio man's fancy should turn to automotive radio—and it will! The June issue of Radio-Craft will contain a comprehensive treatment of all phases of automotive radio.

Get your copy early!

"CORDOHM" WIRE

THE "Cordohm" resistor cable, a product of the Ohmite Mfg. Co., looks like an ordinary lamp cord, but consists of three wires: two copper and one resistance. The copper wires carry the 110-volt circuit and the resistance lead reduces the voltage for the filament circuit.



The "Cordohm" connection cable.

SCRATCH REMOVER

SERVICE Men can readily earn a few extra dollars in their outside work by touching up cabinets in addition to repairing the radio instruments themselves. The handy scratch remover kit marketed by the Erwin-Rabeck Company (illustrated below) can be thrown into a corner of the tool bag.

The material is a filler that seals itself in a few minutes and leaves no noticeable marks or lines.



The scratch remover in action.

GRENARK P. A. AMPLIFIER

THE Grenark-RCA public address amplifier is a two-stage outfit employing rapid heating tubes—one 26, one 50, and two 81's—and is especially valuable for inter-office communication systems wherein the amplifier must function within a second or so after it is turned on. All parts are extremely rugged, and are mounted on a ½-inch wrought iron chassis measuring 17¾ by 12½ by 7½ inches; total weight is 58 lbs.

This amplifier furnishes sufficient field current to energize four 12 inch dynamic speakers, which may be placed in advantageous positions to cover indoor or outdoor audiences. In addition it will operate as many as three dozen permanent magnet speakers. It also furnishes plate currents for a radio tuner.

All filter components are sealed in cans to facilitate replacement and to reduce the effects of temperature changes.



The Grenark amplifier is a husky instrument.

CARTER 32-VOLT GENEMOTOR

OWNERS of 32-volt farm lighting systems have been more or less overlooked by radio engineers, and have been forced to use "B" batteries while other people enjoyed the advantages of power operation. The Carter Genemotor Corporation has come to the rescue with a new 32-volt "Genemotor," which is a small efficient machine of the dynamotor (rotary) type. On the input side it consumes only-half an ampere; on the output side it delivers up to 30 ma. at 180 volts.

No oiling is required, as ball bearings with sealed-in lubricant are used. A double filter system eliminates electrical noise in the radio set. It is furnished in a dirt proof case, complete with connecting cord and line switch, and may be connected in place of "B" batteries.

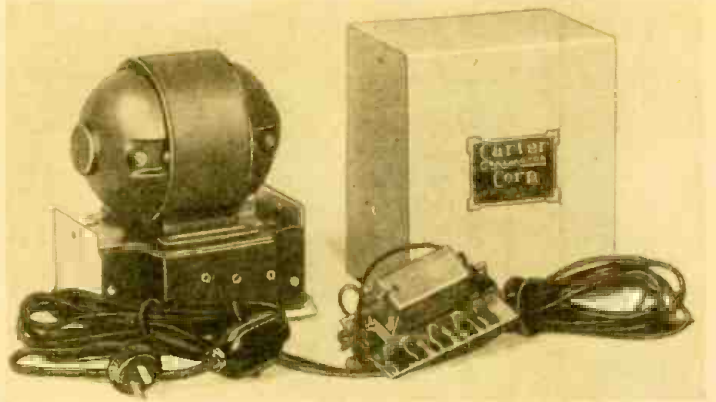

The Carter Genemotor out of its case.

MERSHON CONDENSERS

THE new Mershon wet electrolytic filter condensers illustrated below are designed to meet present day demands for low cost in set construction without sacrifice in performance. They are puncture proof, self-healing and free from mechanical leakage. They are available with either stud or clamp mounting, in a wide variety of capacities to meet circuit requirements.

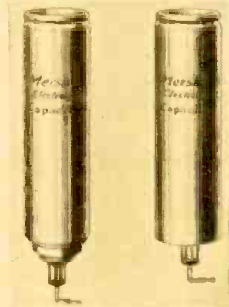

CHROMOXIDE WIRE

"CHROMOXIDE" wire, manufactured by the American Enamelled Magnet Wire Co., is a copper wire having a hard, chemically deposited insulating coating. It is suitable for many radio purposes.

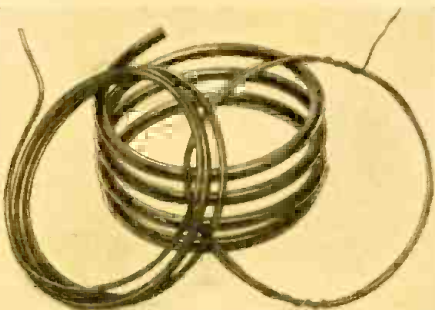

"Chromoxide" wire has a darkened appearance.

ANSLEY DYNAPHONE

RADIO dealers and Service Men are waking up to the possibilities of the portable electric phonograph—not merely a turntable, but a complete outfit. To meet the growing demand, the Ansley Radio Corporation has brought out a well designed instrument called the "Dynaphone," illustrated below. This is a true portable, operating on either A.C. or D.C. It has a self-contained turntable, audio amplifier and dynamic speaker, with provision for microphone connection. Space is also provided in the hinged cover for a stock of records.

The case opens as shown, the cover being held upright by a strong arm. When not in use, the pickup arm is clamped down to protect it from injury.

The opening for the speaker at the front; the tubes and amplifier are directly behind.



The Dynaphone in operation.

RADI-AERIAL

THE "Radi-Aerial" of the Western Coil & Electrical Company connects to the ground and in many locations satisfactorily replaces the outside aerial.



The Radi-Aerial is small and compact.

"COSMOPHONE" PICKUP

THE Winchester Company's "Cosmophone" pickup is constructed of polished bakelite and is equipped with micrometer adjustment for regulating the pressure on the record.

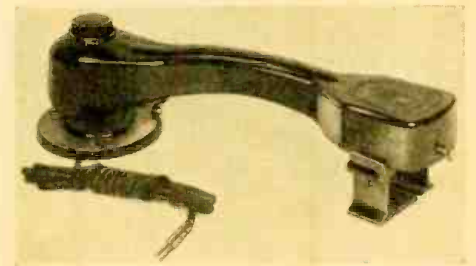

The "Cosmophone" pickup.

ALDEN ANALYZER PLUG

SERVICE Men, experimenters, and engineers who are now finding it necessary to revamp their old test equipment or build new outfits will be interested in the new Alden seven-prong latch-lock analyzer plug, with its attached five-foot, eight wire cable, the seven hole to six-prong adapter, seven hole to five-prong adapter, and seven hole to four-prong adapter.

The analyzer plug is long enough to fit into all standard tube shields. Caps are provided on the side for the cap connections of screen-grid tubes. The latch lock anchors the various adapters securely to the main plug, and prevents separation of the units, which is extremely annoying in sets having fixed tube shields.

For additional information on Alden adapters suitable for all types of testers, see past issues of RADIO-CRAFT.

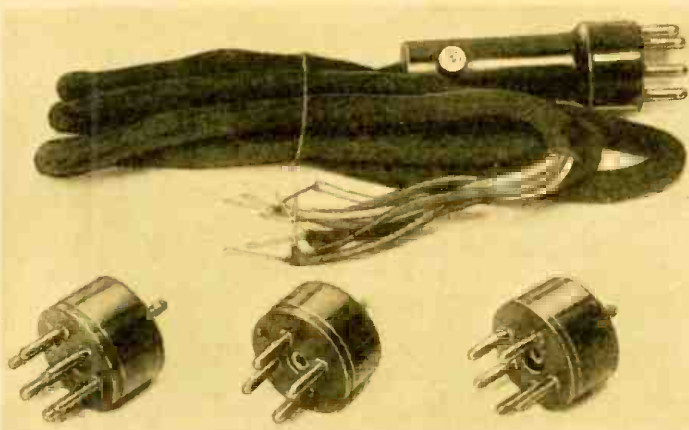

Alden analyzer plug and adapters.



The completed receiver. Its size may be estimated by reference to the pocket watch:

ULYSSES FIPS
(Staff Reporter)

A Revolutionary Radio Development

THE VEST-POCKET, SEVEN-TUBE SUPERHETERO-ULTRADYNE

THE President of the great Westinghouse Radio & Mfg. Company was pacing his office in an agitated manner. Every once in a while he stopped in front of a chart which had curves on it, all of them pointing downward; every time he stopped and looked, he gave a nasty snort and resumed his pacing. Finally, he seemed to have come to a decision, and he pressed a button. A secretary appeared, to whom was given a hurried call for the Chief Radio Engineer. This worthy individual entered somewhat breathlessly into the august presence of the President and blanched visibly when he noticed his chief's scowling appearance.

"Sit down," bellowed the Chief, "and listen.

"For a number of years," he began, "our radio set department has been the joke of the country. Here we are with the resources of the greatest radio manufacturing corporation in the country, and what do we do? We wait until some little manufacturer in a jerk-water town hits upon a good idea about a radio set, and, after he has captured the market, we go and imitate him, and turn out a similar set. All

we have been doing is imitating the other fellow. We haven't produced an original set since the radio boom in 1922. From that time on, every set has been an imitation of someone else's. First the table models, then the consoles, then the midget sets, now the little radios.

"What, may I ask, is our research department for? Are you fellows men or mice? Have you all one-track minds without return ticket privileges, and is originality dead in your laboratories?"

"I am sick and disgusted of imitating other fellows who skim off the cream, leaving us to hold the bag, by forcing us to dump the sets upon the market at less than cost when the shouting is over.

"Now I'll tell you," and here he swung a thick finger under the nose of the unhappy engineer. "I am through imitating. I want action, and I want originality.

"If sets are going to be smaller, ours will be the first radio plant to make them. I'm not going to wait until some watch-maker in Hicksville turns out a vest pocket set and captures the whole United States. I'm going to be the one who is going to make the first," he shouted.

"Now here are your orders: Within thirty days, I want a vest pocket set. Mind you," he said sternly to the trembling engineer, "when I say a vest pocket set I don't mean coat pocket. I want a seven tube set small enough to fit into your vest pocket. There is a tremendous market for such a set. Every woman will wish to carry one in her handbag. Every man will wish to carry one in his vest pocket, attached to his watch chain. Children will

want them. A tremendous market exists in jewelry stores alone. People are already tired of even the little radios which go into your desk drawer. Nor do I want a set that requires an aerial.

"Have you wise engineers ever heard of super-regeneration, where amplification is so great that an aerial is not really needed?"

"But," faltered the flabbergasted engineer, "where will you get a loudspeaker small enough—"

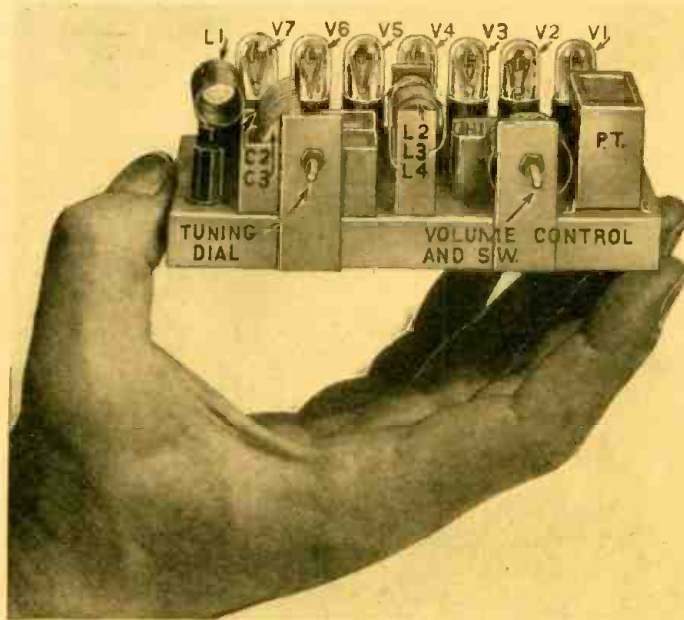

Photograph illustrating the size of the set in comparison with the hand. All components are marked for convenience.

THE present extraordinary radio development, which appears for the first time in any publication here, is the logical outcome of small sets. When the midget set first was announced, the radio industry threw up its hands in horror because they could not conceive that a radio set could be built in such a small space. Then came along the four-tube little radio sets, small enough to put into your desk drawer. How much smaller can radio sets be made? The present receiver seems to furnish an answer to this question.

While this set is small enough to fit into the vest pocket, he would be a rash prophet who would dare say that it is the ultimate. Sooner or later, someone will probably build a radio set which, complete with tubes and speaker, will be the size of a watch. That may, or may not, be the ultimate. It looks, however, that the radio industry will soon have to put watchmakers to work in order to assemble these microscopic sets, if present indications are right—and the facts are that present indications are right!

"Silence," bellowed the boss of the great works, "who talks of loudspeakers? Why must you fellows always wear grooves in your one-track minds? Why not be original? Have you never heard of singing arc lights? Have you never heard of the talking electric lamp bulb? Where was your loudspeaker there? Is it written anywhere that you must have a loudspeaker such as you understand the term in order to get sound? Have you ever heard of a talking condenser? Have you ever heard of a talking glove? Have you ever heard of the singing dynamo which emits sound due to molecular vibrations? All you fellows do all day is to putter around in your laboratories, note all these peculiar effects, but never translate them into action. There are ways and means to make a radio set sing and talk without loudspeakers, and it is up to you to use the best means.

"Now, before I lose my patience, get out and break the news to your fellow research imbeciles and deliver a vest pocket set to me within thirty days. Here," he said, "is my desk calendar." And taking a red crayon, he marked the 5th of the month, when the set was to be delivered.

* * *

Here the curtain descends for a lapse of thirty days, at the end of which the chief engineer and his assistants, smiling, walk

into the presence of the august President, and set upon his desk the set here shown by *actual photographs*. The engineer plugs the line cord into the nearest outlet and tunes in a station. The new set called, "The Vest Pocket Seven Tube Superhetero-ultradyné," is a seven-tube affair, and, by actual measurements, is found to measure only 4"x2", just small enough to fit into your vest pocket.

The President beams as the set is demonstrated, when station after station, local as well as distant, is tuned in with ease. "Good work," says the Boss of the Works, slapping the Chief Engineer on the back. I knew it was in you and I knew right along it could be done. How much do you think it will sell for?"

"About \$5.00 or thereabouts would still net us a good profit, but before we go into that," he said with a twinkle in his eye, "watch this." And now the engineer played his trump card. He gave a jerk, and off came the lamp cord connection which had been plugged into the lighting circuit. From his pocket he pulled out what looked like a sub-base of the radio which he fastened to the bottom of the Lilliputian set. Immediately the set started to play as before. The head of the big corporation was astonished, and began to ask questions.

"Let us begin at the beginning," said the enthusiastic engineer. "This set is both for A.C. and D.C., as well as battery opera-



The tube! Note its similarity to the filamentless tube described in the March issue of RADIO-CRAFT. It will become as famous as the APR 1.

Read This Article Now! The Amazing Possibilities of Vest Pocket Receivers Will Take Your Breath Away. It is the Ultimate Set for Years to Come

The receiver described by our star reporter, Mr. Fips, represents one of the greatest advances in the radio art. Mr. Fips, who for the past twenty-five years has been associated with radio, considers this receiver to be the pinnacle of his radio achievement.

tion. The thing which you take for a sub-base is really the "A" and "B" supply. No aerial nor ground are needed. You take the little set out of your vest pocket anywhere, and you get, not only broadcast reception, but, if necessary, with a little extra addition, we can also bring in the short waves by pulling this little switch in the bottom.

Of course, many problems had to be solved. First, we had to get a special miniature vacuum tube. None were existent. There was no reason to make vacuum tubes as large as they have been made, so we proceeded to make new tubes of a special nature which require no filament but work

on the principle of cold electronic emission*. This tube is very economical, and uses but little current. Several new principles had to be incorporated into the tube because the tubes themselves become a sort of loudspeaker. You will note that the new tubes themselves are all carried on a special diaphragm, and by molecular action, their vibrations are carried to this oblong vibrating diaphragm from which the sound issues. The tubes themselves, as you will notice, are quite microscopic in size; in fact, they measure only one inch overall by $\frac{3}{8}$ inch in diameter. There are seven such tubes in this set. As to the set itself, it is not very complicated, as you will see from the blueprint here.

"The set uses super-regeneration in addition to triple regeneration of a special nature worked out by our research laboratories. The tuning condensers presented a little difficulty in order to get the wave range, but here again our engineers did wonders. You will note that the tuning condensers are so minute it would not be possible to cover the entire broadcast waveband. We, therefore, resorted to a new trick, and that is, we work this set on harmonics only.

"As is well known, practically every broadcast station can be received on short wave sets due to harmonics. We utilize this principle and simply boost up the harmonics again in inverse ratio. This, in practice, works excellently, and

*Read RADIO-CRAFT, March issue for further information on the principle of this tube.

does away with overlapping frequencies and, as you will also have noticed, the set is exceedingly sharp in tuning. For that reason too, it has no dead spots. Because

it uses no aerial, very little man-made static is experienced. There are, therefore, no extraneous noises which, so far, have been the bane of radio. Of course, everything had to be worked out with watchmaker's precision; but, all problems have now been solved, and, after tooling up, we will be in a position to offer the set as the greatest radio marvel of the age within the next thirty days, should you think this to be necessary. And, of course, the price is highly attractive, too;

with a list price of \$5.00, actually millions of people will buy, not one, but numbers of these sets."

While the chief engineer kept on talking enthusiastically in this manner, the Big Boss's face became darker and cloudier. He took a pad of paper and did some figuring. The more he figured, the more perturbed he became.

"This is a fine set," he sneered, "but unfortunately, the economics connected with it do not seem to work out so nicely. As a matter of fact they are super-lousy. Even with the old midget sets selling for \$75.00 we couldn't make any money, and with all the little radio sets selling for \$25.00 we can't make money; now, how much do you think we can make on a \$5.00 set? As a matter of fact, I think that while you have produced a marvelous contraption you were thinking only of price instead of quality. Instead of making a higher priced set, you have concentrated on the price angle. Fools like you are the ones who kill the radio industry."

With rising anger, and his face turning from red to

a purple, he grabbed the set and hurled it at the unhappy engineer who collapsed as the result of the impact.

The crestfallen and totally crushed engineer awoke with a start, and found that his cat had jumped on his chest just a minute before the alarm clock went off. He looked around sleepily and his wandering eye lit upon the calendar. He noted the date and groaned. IT WAS APRIL FIRST!

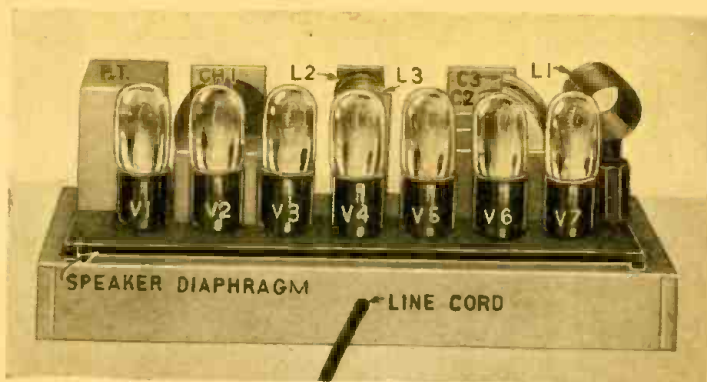

Rear view of the set. Again, all values are marked for the convenience of the constructor, should he wish to build the set. The tubes become a loudspeaker.

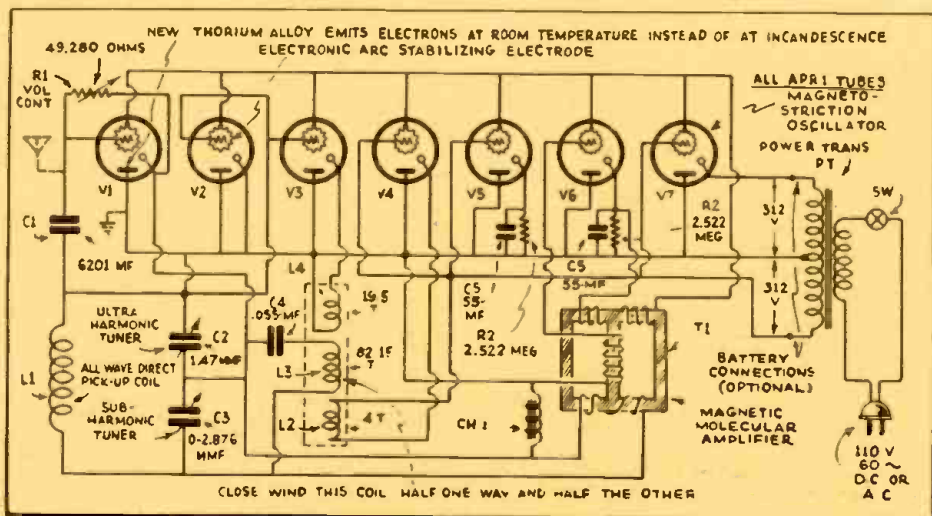

Complete schematic circuit of the receiver. The electromagnetic waves from the ether (if there is such a thing as the ether) impinges upon the input to the receiver causing the magneto-striction oscillator to beat with the supersonic frequencies of the magneto-molecular oscillator, giving rise to the Super-hetero-ultradyn. It is interesting to note that the fundamental principles employed in this receiver have never before been utilized in any commercial receiver. Magneto-striction oscillators have been used so have magneto-molecular oscillators, but the combination of the two is, indeed, rare. Note the unique method of winding the coil.

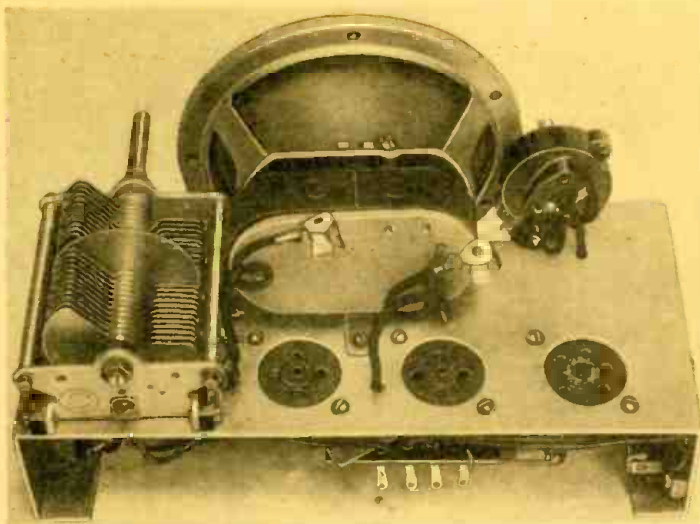

Fig. A

Top view of the chassis showing the location of all parts above the deck.

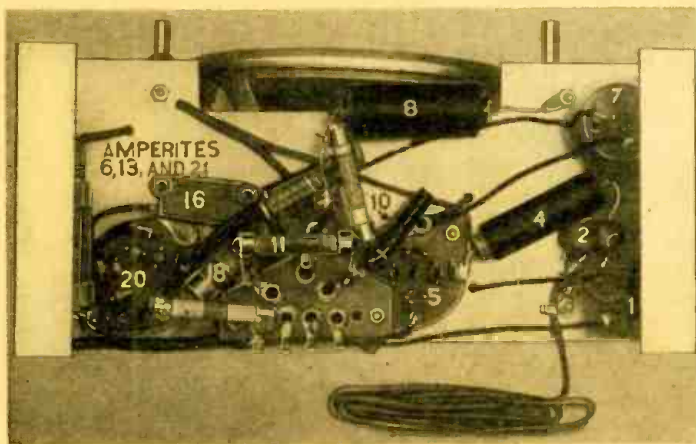

Fig. B

Under-view of the receiver. The designations refer to the circuit, Fig. 1.

THE "Personal" receiver is a versatile 2-volt battery-operated set. If energized entirely with dry cells, it makes an excellent portable, since it is one of the smallest, lightest battery sets ever designed. It makes an ideal air-cell receiver, as the total filament-current drain is less than 4-ampere. Through the utilization of amperites, the Personal set can be powered, if desired, by a standard 6-volt storage battery. Three 45-volt "B" batteries are required. The total "B" current drain is less than one-fortieth of an ampere. See Figs. A, B, and 1.

The keynote of the "Personal" receiver is simplicity: it uses but three tubes. These tubes are employed in an efficient circuit requiring comparatively few parts; non-essentials have been eliminated; no transformers are used; the speaker is connected directly in the circuit, thus dispensing with speaker plug and socket. Even antenna and ground binding posts are not used—the antenna is connected to a flexible wire coming from the set. The ground connection is made at the negative terminal of the "A" battery.

Through the application of modern design principles and through the use of the latest two-volt pentode tubes, and also of other improved components, this little sub-midget outperforms old-style battery sets taking up to four times as much space and using twice as many tubes. The three-tube circuit consists of a tuned R.F. stage employing a 34 variable-mu pentode, a tuned detector stage using a 32 screen-grid tube, and an audio output stage using a 33 power amplifier pentode.

Description of Circuit

The detector is coupled to the output stage by resistors. The 33 output tube gives undistorted high gain with low signal inputs. This tube has an undistorted power output

BUILDING A

BATTERY-OPERATED "PERSONAL" RECEIVER

A battery-operated midget receiver of the "personal" type. It may be used in a car or at home, at will. All details are given.

H. G. CISIN, M.E.

of 700 milliwatts at 135 volts on the plate. Volume is controlled by means of a tapered potentiometer in the screen-grid circuit of the R.F. tube. Reducing the screen-grid voltage below $67\frac{1}{2}$ gives smooth, uniform control of the volume.

The amperites (6, 13, 21) in one of the filament leads of each of the three tubes serve to reduce the filament voltage from the 6 volts supplied by the storage battery to the 2-volt value specified for the tubes. They also provide automatic filament voltage control, as the storage-battery voltage drops. For this reason they are far preferable to ordinary voltage limiting resistors. If there is a short in the filament circuit, the amperites function as fuses.

As an additional inexpensive, but valuable, protection to the receiver, a fuse is placed in the "B-minus, A-plus" line, as shown in the schematic diagram, Fig. 1. This fuse gives both "A" and "B" protection. The fuse should always be left in the circuit, regardless of the type of "A" battery used.

The chassis is bent from a $13\frac{3}{4} \times 4$ inch sheet of No. 14 gauge aluminum. The three socket holes should be drilled before making the four bends. A rectangular cut is also made at the front end of the chassis, prior to bending, to permit the speaker cone to extend below the chassis deck and to be flush with the front. This cut is $4\frac{1}{2}$ inches long \times $\frac{3}{4}$ inches deep. It is shown clearly in the under-chassis view, Fig. B.

After the chassis is bent, the three sockets are mounted.

(Continued on page 685)

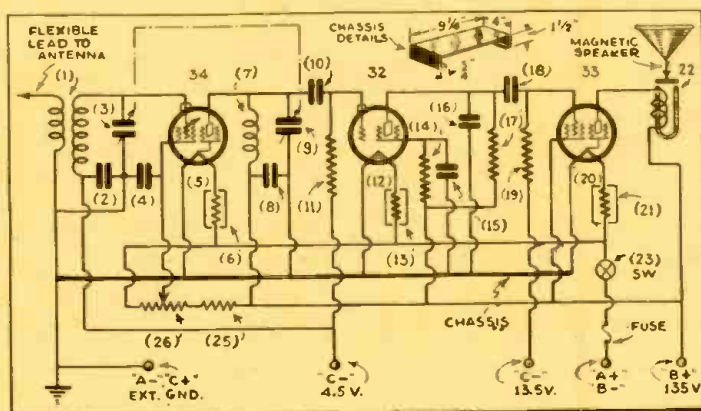

Fig. 1

Complete circuit of the "Personal" receiver described by the author.

BUILDING A LABORATORY-STANDARD ANALYZER

A description of a one-meter analyzer suitable for numerous laboratory purposes. This tester is designed for use with the new Westinghouse meter and external rectifier. It tests all tubes and is suitable for point-to-point resistance measurements, and impedance measurements. It is extremely flexible in operation.

LEON J. LITTMANN, E.E.*

THE analyzer herein described has been designed with the dominant thought in mind of incorporating as many as possible of the advantages and improvements possessed by analyzers now on the market. There have also been incorporated in this new instrument many other radically new and vital features not usually found in modern analyzer equipment. This analyzer can thus be used in conjunction with any one of the new tubes, even though such tubes should be used in conjunction with A.V.C., resistance, or direct-coupled circuits.

As a matter of fact, many, many letters were received from Service Men who complained that their test instruments had become obsolete, in that

their testers neither allowed them to analyze the ever increasing number of new tubes, nor allowed them to make many of the now vital tests that are so necessary today.

The analyzer to be described was designed, then, to satisfy the demand for a truly *all-purpose* instrument as required by all present-day, as well as future, laboratories, Service Men, technicians, sound engineers, etc. The defects that are so numerous among most present-day service and analyzer apparatus were, of course, minimized, to keep step with modern progress.

Full schematic and picture diagrams, as well as detailed explanations of the various test circuits and testing applications, and a list of parts are given herein to enable anyone to build, with-

out any difficulty, this portable laboratory at a relatively low cost and with astonishing ease.

Rather than to go into a lengthy discussion of the numerous handicaps encountered in other test apparatus, this detailed description will be confined to a discussion of the finished product, which has been designed with all of the aforesaid taken into consideration and which incorporates the features given below.

Here is a list of some of its outstanding features:

(A) This analyzer is primarily intended to be used with the new Westinghouse meter that has been especially designed for this tester, although enough information is given in this article to enable the optional use of any similar

*Chief Engineer, Coast-To-Coast Radio Corp.

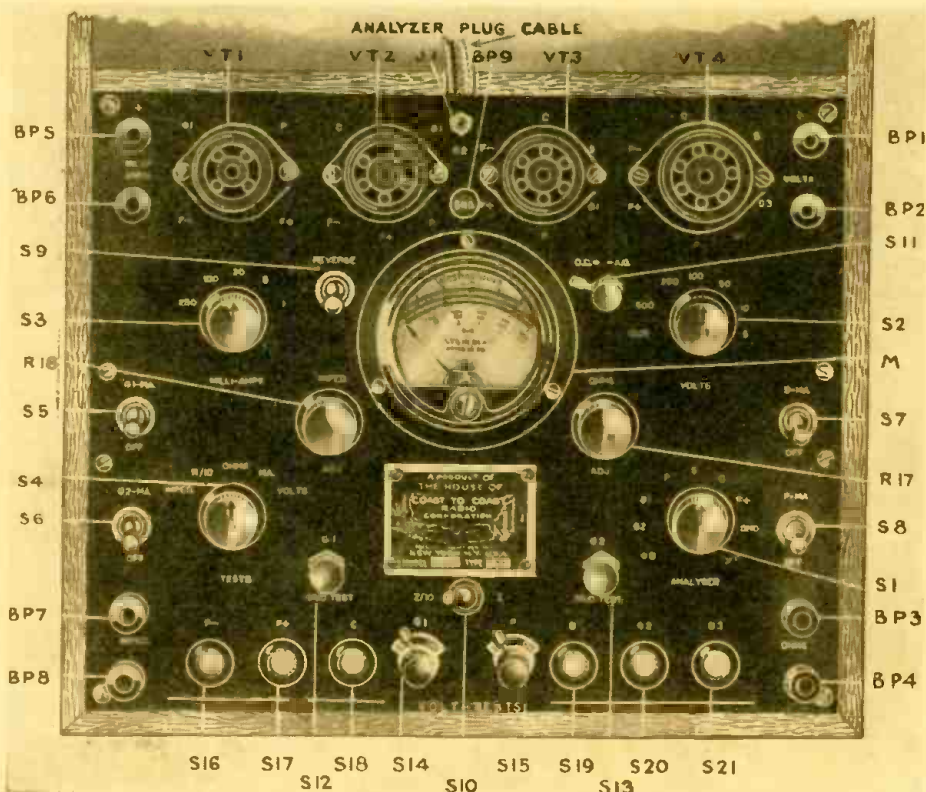

Fig. A
Panel view of the tester with all controls marked. See Fig. 2, also.

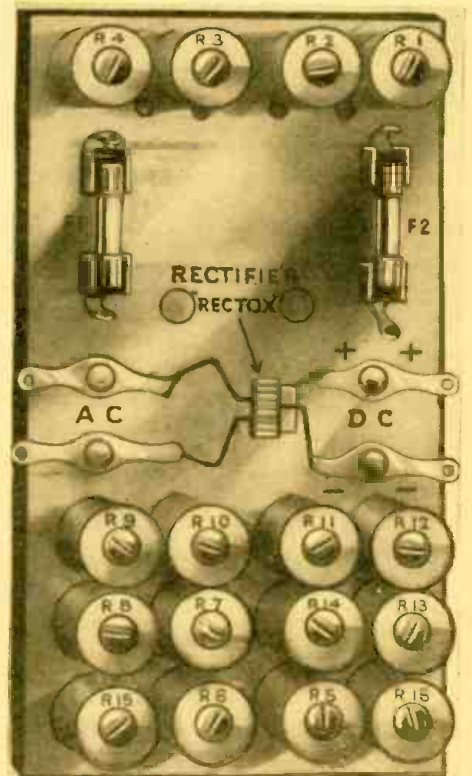

Fig. B
Photograph of the panel used to house the resistors as explained in the text and in Fig. 2.

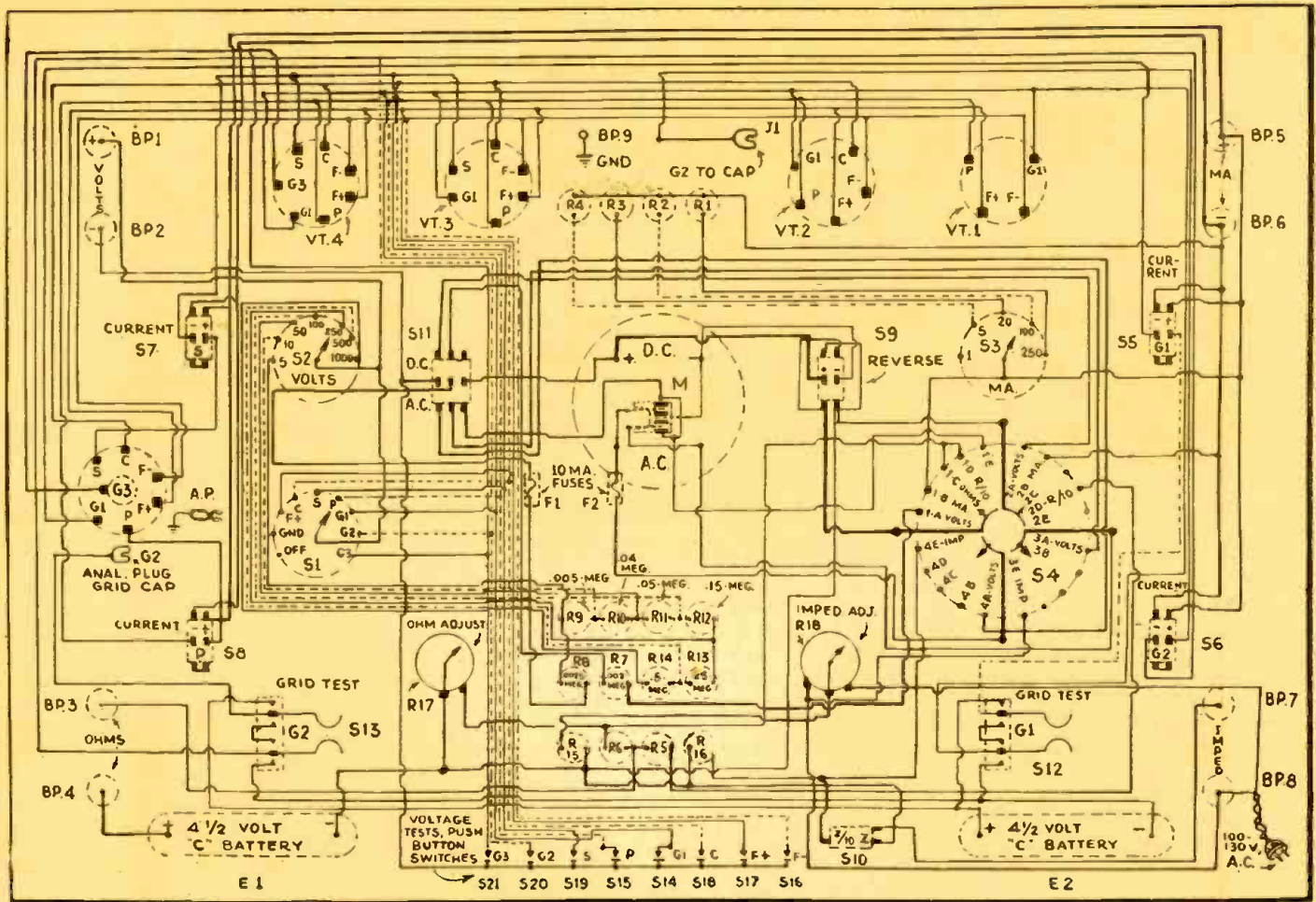

Fig. 2
Complete schematic circuit of the versatile tester with all values marked for convenience.

meter (such as the Weston 0-1 milliammeter, D.C., equipped with a copper-oxide rectifier). This Westinghouse meter which, until recently, was manufactured almost exclusively for switchboards and laboratory purposes, is now available to readers of RADIO CRAFT. (This meter is shown elsewhere in this issue.—*Editor.*)

(B) The front panel layout is given in Fig. A, and the rear view of the resistor panel is given in Fig. B. Note the use of individual 4-, 5-, 6-, and 7-prong tube sockets. The use of individ-

ual sockets permits a tube under test to be quickly inserted into its easily identified socket, thereby avoiding the use of adapters and the use of universal sockets that may get out of order quickly, or break down under the high voltages applied.

Principles Used in this Analyzer

(C) The actual analyzer principles employed in this analyzer were formerly employed with great success by the writer in designing the 1931 model of the Coast-to-Coast Radio Corp.

Analyzer. Its fundamental idea is to be able to test D.C. or A.C. voltages with any one of the meter ranges between any two tube prongs (or between any prong and ground or grid cap), and to identify this reading immediately and unmistakably. So far, practically all analyzers on the market make, for instance, a plate-voltage reading. But how is this reading obtained? Is it measured between plate and filament, cathode, ground, or grid? The answer to this question lies usually
(Continued on page 689)

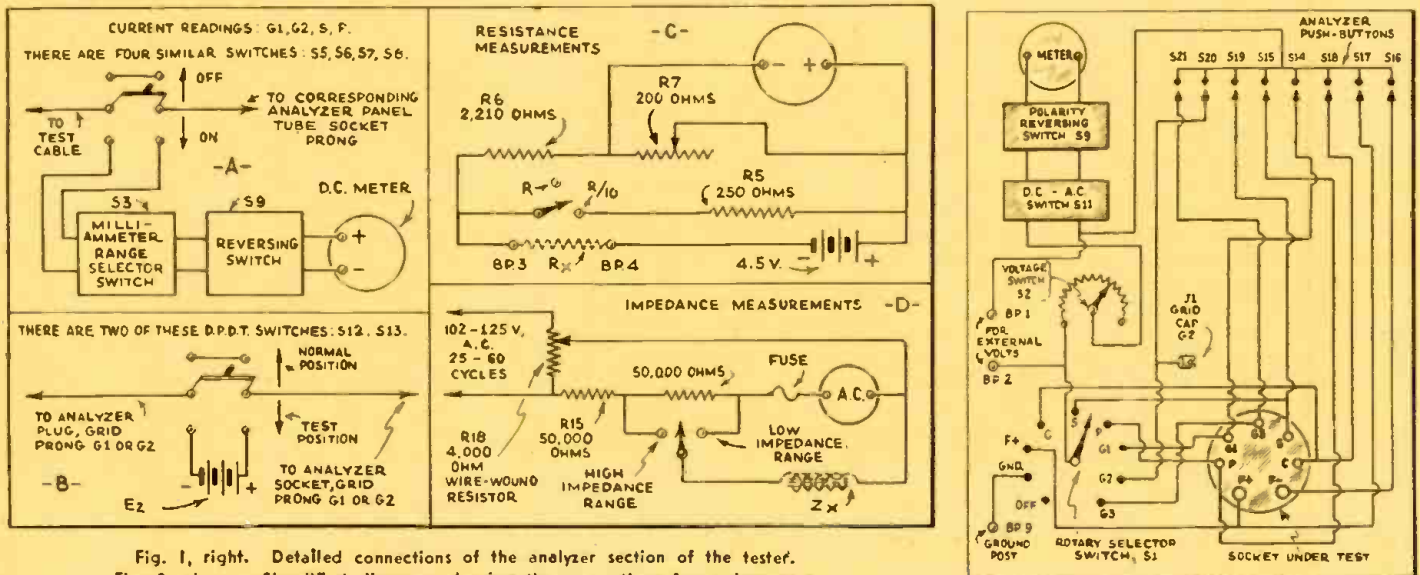

Fig. 1, right. Detailed connections of the analyzer section of the tester.
Fig. 3, above. Simplified diagrams showing the connections for various uses.

MAKING MONEY WITH AMPLIFIERS

Part Five of a series written for Service Men who want more business. In the present article the authors emphasize a portable amplifier and public-address system designed especially for use in small automobiles. This works entirely on the car's regular six-volt storage battery and draws only eight amperes.

HUBERT L. SHORTT

and FRANK LESTER*

LETTERS received by the authors, as a result of the previous four articles of this series, indicate that there is a widespread demand for a simple, compact amplifier (and associated accessories for public address work) that will work entirely from the regular six-volt storage battery of an ordinary passenger automobile.

"Big sound trucks with expensive equipment may be all right in the big cities," write our correspondents, "but in smaller cities no one can afford such luxuries. When a portable or mobile amplifier is needed for most small-town 'jobs,' the family 'bus' is pressed into service and all necessary junk must be thrown into the back. Give us some hints on rough-and-ready P.A. work of this kind."

There are now a number of good portable six-volt amplifiers on the market. For the most part, these use tubes of the 6.3 volt series, with the filaments working directly from the car battery, and the plates drawing current from a small, specially designed dynamotor that, in turn, also works from the storage battery. With "B" batteries eliminated, the major source of trouble with portable outfits is also eliminated, and maximum output at all times is assured.

Battery Condition Important

The last statement must, of course, be qualified: The over-all operation of the entire P.A. system is dependent on the condition of the car battery. If the Service Man uses his own car for portable work, he should invest half a dollar in a hydrometer and take readings on the battery at least once a week. Like the shoemakers with run down heels and the bartenders who don't drink, many radio men are very negligent of their own electrical appliances, and are just the ones who get stuck with dead batteries. The authors questioned a dozen Service Men at random, and learned that only one of them owned a hydrometer, and he hadn't used it in two months!

If you use your car for short trips around town on service calls, and the battery doesn't get much of a chance to charge up respectably, do one or both of two things: advance the charging rate by adjusting the third brush

on the charging generator (an operation that takes five minutes), or pick up a small battery charger—they're extremely cheap nowadays—and keep the battery as near 1300 on the hydrometer as possible. This attention is good business all around: the battery lasts longer, the car starts easier, and the portable amplifier will always speak up at full volume.

Install Permanent Outlets

Don't wait for your first outside P. A. job to do a lot of rush wiring in the car. Buy an assortment of single and double contact flush mounting receptacles and mount them permanently in convenient places. Use the single contact outlets for battery supply. Put one on the dashboard, another some-

where under the edge of the rear seat, and perhaps a third on either step plate, so that you have "juice" available on the outside of the car. Use the double contact receptacles for loudspeaker and microphone connections, and mount them in a hinged, weather-proof little box on the step plate or under the running board. All these outlets are, of course, wired into the car so that when the amplifier is thrown in, the whole outfit can be inter-connected by bridging cables with suitable plugs on their ends. The outside outlets obviate the necessity for wires draped over windows or through doors, and make the installation look much more business-like. Incidentally, beware of wires through doors. Some one is sure to slam the latter, and snip! go the wires.

Carrying the loudspeaker or speakers in a small car is often quite a problem. If you want to attract attention, build a cradle of some kind to fit the top of the car and carry the speakers there. For outdoor work, speakers of the trumpet type are, of course, desirable.

A Portable Amplifier

A representative portable six-volt amplifier, designed by the authors to meet the special requirements of small car work, is illustrated in the various views on these pages. This amplifier is the new Lafayette Six Volt Amplifier. Measuring only 10 3/4 inches wide, 8 3/4 inches deep, and 7 3/4 inches high, it is readily mounted on the running board or trunk rack, or may simply be placed on a seat, or the floor. The pressed steel housing contains a complete three stage amplifier, with the plate supply dynamotor mounted on rubber behind the tube line-up. This dynamotor is a special little machine designed for quiet running and maximum efficiency. Making the plate supply an integral part of the amplifier keeps the high voltage safely confined. With loose "B" batteries or a separate generator, and with "B" minus grounded to the car through the grounded storage battery, there is likely to be plenty of fireworks when a wire accidentally slips.

Six tubes are used in the amplifier circuit: one type 36 as a voltage amplifier feeding one type 89 pentode



Appearance of the Lafayette six-volt amplifier; the dynamotor that furnishes plate current is in the housing behind the tube line up. Along the front of the chassis are the following (left to right): speaker jacks, three-position output impedance selecting switch, main supply switch, and microphone input jacks. The two tube shields cover the type 36 and first type 89 tubes, and guard against external pick up.



Back view of the Lafayette six-volt amplifier with the back housing removed to show the special six volt dynamotor and its soft rubber mounting.

*Wholesale Radio Service Co., Inc.

driver, which in turn, works into four type 89's in class "B" parallel push-push. The output, which is close to ten watts, is enough to make voice or music heard at large outdoor gatherings. A single large trumpet may be used, as shown in the photographs, or a triple trumpet fed by a single dynamic unit. Connections are provided on the amplifier for convenient connection of six-volt dynamic speaker fields, and also for the local microphone-current supply. A microphone control box, incorporating a gain control, is available separately.

One of the features of this amplifier is a voice coil impedance matching switch, which has three positions representing impedances of 4, 8, and 15 ohms, respectively. This enables the user to adjust the output most satisfactorily to the particular loudspeaker or combination of speakers that he intends to use.

An additional secondary winding on the output transformer has output impedances of 500 and 2,000 ohms, respectively. The 500-ohm section is useful for line matching purposes, while the 2,000-ohm section is intended for magnetic speakers.

The use of a rotary machine of the dynamotor type, instead of less expensive units of the vibrating type, was decided on by the authors after numerous tests had been made on representative instruments of both classes. The machine in this amplifier is entirely enclosed and is self-lubricating. Its regulation characteristics are exceptionally good, and were made so to meet the changing current requirements of class "B" audio amplification.

Commutator Ripple Eliminated

The single switch in the six-volt line, marked SW in the diagram, controls the tube filaments, the dynamotor and the dynamic speaker field supply. A simple filter in the high voltage circuit, consisting of an audio choke and a pair of heavy by-pass condensers, smooths out the commutator ripple from the generator and is responsible for the absolutely noiseless operation of the amplifier.

In the diagram T1 is the push-push input transformer, T2 the special output transformer with two tapped secondaries. The tube filaments are all in parallel.

Quickly Set Up

The accompanying illustrations show this amplifier, with the mike control box and an aluminum trumpet, in actual use in a Ford convertible sedan. This outfit has been driven through many parts of New York, and never fails to attract an immediate crowd. The apparatus is set up or removed in about five minutes. It has also been used in a roadster, a sedan, and a small delivery truck.

One of the things Service Men must consider in operating a mobile amplifier of this type in an automobile, for street "ballyhoo," is the sentiment of the local police toward such stunts.



The authors operating the amplifier as part of a small public-address amplifier. Mr. Shortt is at the microphone, Mr. Lester is in the back. The mike control box and the amplifier itself are on the back seat. The loudspeaker is protruding from the right side.

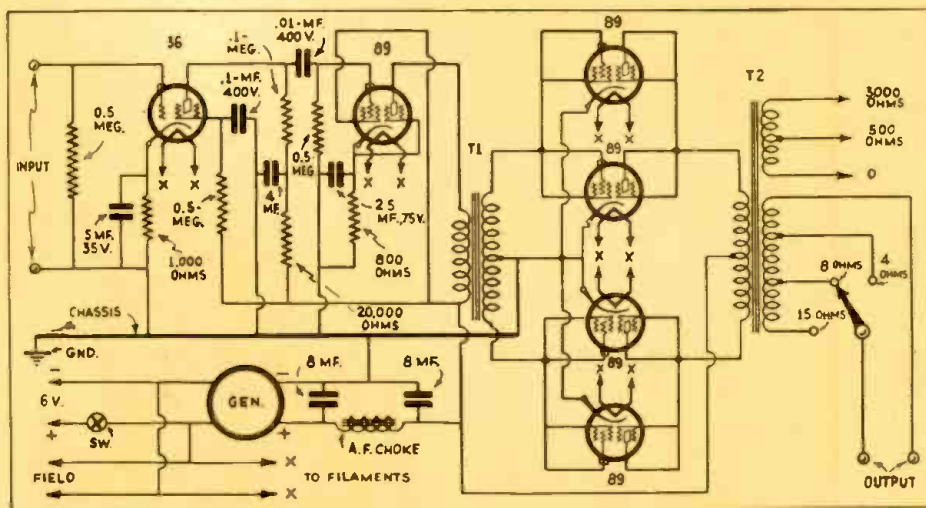

Complete schematic diagram of the Lafayette six-volt amplifier, showing the values of all parts. Note that the class "B" output stage employs two pairs of type 89 pentodes with the plates, grids, screens and cathodes of each pair connected together. The output transformer T2 is provided with two sets of tapped windings for different combinations of magnetic or dynamic loudspeakers. The microphone is connected to the input side of the amplifier through a coupling transformer, in the usual manner.

There are many large travelling trucks fitted with elaborate sound equipment that have more or less ruined this angle of the business because they overdo it. Up to a certain point the "ballyhoo," as it is delivered through the speakers, is interesting, but when the racket starts disturbing sleeping children, invalids and the like, it must be stopped. Don't wait for the police to give your P.A. business a black eye by clamping you in jail for disturbing the peace; use some discretion and you'll get repeat orders.

Radio Operation

Of course, the application of an audio power amplifier of this type is not limited to voice announcements or phonograph records. It may be operated just as well from the detector stage of any

ordinary broadcast or short wave receiver, with a suitable coupling medium. The latter may take the form of low ratio transformer if the detector is of the triode type, or a coupling condenser if the detector is of the tetrode (screen grid) type.

For street ballyhoo work, a regular auto radio receiver will save much wear and tear on the available phonograph records and also on the announcer's voice. Incidentally, this combination may be employed for the exploitation of the particular auto receiver the Service Man or his employer is handling. Instead of waiting for people to come to the store to hear the set, bring it to their attention by way of the additional amplifier and loud speaker.

plate circuit moves over and closes the filament circuit (FF), and so on. All jumpers move over one pair of contact points, while the two separate contact points, MM, of the inner disc are now in the G2, or grid circuit, and the meter is now connected into this circuit, reading grid current. If the switch is again revolved to the right, filament current will be read, and so on. Later, I will describe how voltage can be read with the same switch.

The right-hand side of the wiring diagram is the meter arrangement of the analyzer. A dry-disc rectifier is utilized so that A.C. readings may be read on the D.C. meter. This necessitates using a triple-pole, double-throw toggle switch, Sw. 4. When A.C. voltages are to be measured, the switch is thrown to the A.C. side; when D.C. voltages or currents are to be measured, the switch is thrown to the D.C. side. This triple-pole, double-throw switch throws the rectifier completely out of the D.C. circuit when the switch is thrown on the D.C. side. In most analyzers utilizing a rectifier, the designers do not avail themselves of this means of throwing the rectifier out of the D.C. circuit when testing D.C. Because of this failure, the accuracy of the readings are impaired.

Directly below the triple-pole, double-throw switch is the meter reversing switch Sw. 3. Four resistors, R1, R2, R3, and R4, having values of 10,000, 100,000, 500,000, and 1,000,000 ohms, are used to increase the meter scale by 10, 100, 500, and 1,000 times when reading either voltages or currents. Each scale may be selected by depressing one of the push buttons situated directly below the resistors. Switch Sw. 2 is a standard bi-polar, three position switch. I made this switch from two single selector switches that I had in my junk box. These selector switches have six contact points and an off position; it is shown as such in the photograph of Fig. B, although I only utilize three of the positions. When this switch is revolved to the last position, MA, it automatically inserts a 1,000-ohm resistor, R5, in the meter circuit.

When the measurement of current is desired, Sw.1 is revolved to the desired position, and one of the push buttons, Sw.5, Sw.6, Sw.7, or Sw.8, is depressed, thus putting the 1,000-ohm

resistor in shunt, through the low resistance meter, with the resistor selected by the push button; the entire arrangement is in series with the circuit which has been selected by Sw.1; a current reading is automatically obtained on the meter. The value of current depends upon the voltage drop across the 1,000-ohm resistor. When Sw. 2 is in the first position, F, points MM are shorted, and the voltage of any circuit (the circuit is chosen by Sw. 1) is read, referring to the filament. The proper voltage scale is chosen by depressing one of the push buttons. When Sw.2 is on the second, or K, position, all voltages are measured with respect to the cathode. It is standard practice to measure all voltages in heater-type tubes from the cathode.

External Measurements

All meter ranges are brought out to four binding posts, B1, B2, B3, and B4, from which all external measurements are made. Placing Sw.2 on F, all D.C. and A.C. voltage ranges of the meter are available between binding posts B1 and B2. Placing Sw. 2 on MA, all D.C. current ranges of the meter are also available between binding posts B1, and B2. Continuity and resistance measurements are measured between binding posts B1 and B3. For resistance measurements, a 4,000-ohm resistor R6 is used with a 5,000 ohm rheostat R7 and a 4.5-volt "C" battery; the rheostat R7 is used to adjust the battery until the meter reads full scale. When this is done, the test leads should be placed across the unknown resistor, the deflection of the meter should be read and then referred to the resistance scale, Fig. 3, to determine its value. Output measurements are made between binding posts B1 and B2. When a low output scale is desired, measurements should be made between binding posts B1 and B4; rheostat R7 should be used. To use the 0-1 ma. scale, place the test leads between binding posts B1 and B4; rheostat R7 should be in the "off" position. A scale may easily be calibrated for the measurement of condensers. Tests of condensers should be made between binding posts B1 and B2. Of course, Sw.4 should be thrown to the A.C. position for A.C. voltage, current and condenser measurements.

(Continued on page 688)

POSITION OF SELECTOR SWITCH, SW. 1					
TUBE TYPE	PLATE VOLTS OR CUR.	GRID NO. 1 VOLTS OR CUR.	GRID NO. 2 VOLTS OR CUR.	GRID NO. 3 VOLTS OR CUR.	CATHODE VOLTS OR CUR.
00 A	P	G2			
01 A	P	G2			
10	P	G2			
WD II	P	G2			
WX12	P	G2			
12 A	P	G2			
20	P	G2			
22	P	G1			
24	P	G1			K
26	P	G2			
27	P	G2			K
30	P	G2			
31	P	G2			
32	P	G2	G2		
33	P	G2	K		
34	P	G1	G2		
35	P	G1	G2		K
36	P	G1	G2		K
37	P	G2			
38	P	G1	G2		K
39	P	G1	G2	G3	K
40	P	G2			
41	P	G3	G2		K
841	P	G2			
42	P	G3	G2		K
44	P	G1	G2		K
45	P	G2			
46	P	G2	K		
47	P	G2	K		
49	P	G2	K		K
50	P	G2			
55	P	G1			K
56	P	G2			K
57	P	G1	G2	G3	K
58	P	G1	G2	G3	K
64	G	G2			
66	G1				
71A	P	G2			
80	P				
81	P				
82	P				
85	P	G1			K
99	P	G2			
8A					
8H					
LA	P	G2			
WUNDERLICH	G2				G1

SW.1 SET ON 'F' FOR ALL FILAMENT VOLTAGES; SW1 SET ON 'G2' FOR 2ND PLATE TEST OF 80, 81 & 82 TUBES.

Fig. 4

A chart showing the position of the switch for various tests. Others may easily be added. A description of the switch is given in the text.

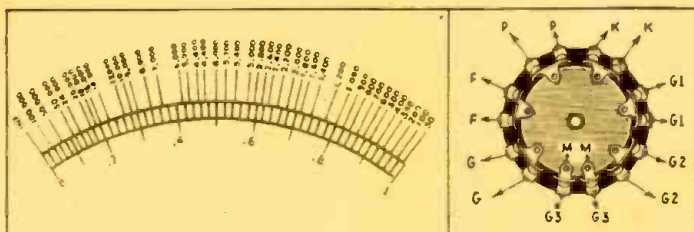

Fig. 3

An enlarged sketch of the meter dial.

Fig. 2

The special switch used.

FEATURES OF THIS ANALYZER

It is small, thus taking a minimum amount of space in the tool kit;
 It is easy to assemble and simple to wire—a blessing to the man beginning to service radio receivers;
 Tests all 4-, 5-, 6-, and 7-prong tubes without any adapters, except those on the analyzer plug;
 May be used as an ohmmeter, voltmeter, milliammeter, and output meter. No shunts are required.

A VOLT-OHMMETER AND MILLIAMMETER

A description of a simple tester which measures voltage, current, and resistance. It has several unique safety features which further facilitate its utility.

MILTON REINER*



Panel view of the Multitester showing the location of all panel controls.

THE importance of considering obsolescence, adaptability, and economy has frequently been stressed when purchasing, designing, or building test equipment. With some few exceptions, it seems that we in the radio industry "never learn," as we constantly see new instruments announced that do not consider these factors of prime importance.

Experience has shown that circuit design changes rapidly with the frequent improvements and additions to the various types of tubes. The voltage and current ranges for measuring instruments are entirely different from what they were several years ago. Yet, there are a large number of the older sets as well as the modern ones to be serviced.

Regardless of changes that have tak-

*Chief Engineer, Radio City Products Co.

en place and which might occur in the future, there is every reason to believe that any meter that will measure voltage, current, and resistance in a successive series of scales will always be of maximum utility. With this point in view, the Multitester has been designed as a compact, economical, self-contained testing instrument which is complete in itself, or may always serve as the heart of a super-flexible analyzer system, other units of which will be described at some later date.

The Multitester is so designed that great flexibility is available for modern testing methods at maximum economy and efficiency so that it can always be used as a multiple-purpose meter regardless of what changes may take place in the future. In short, it is a multiple range, combination ohmmeter, voltmeter, and milliammeter, all self-contained. The ohmmeter has a triple range: the low-scale reading is from 0-2,000 ohms, the first division representing $\frac{1}{2}$ ohm. The ability to indicate resistance values of $\frac{1}{2}$ ohm

and less is of considerable value in testing R.F. circuits; the second ohmmeter scale is from 0-200,000 ohms; while the third, or high range, is from 0-2,000,000 ohms. Of course, it is possible to measure resistances up to 6,000,000 ohms and higher by putting external batteries in series as is sometimes resorted to by a few manufacturers.

All voltages are indicated directly on the meter which has a sensitivity of 1,000 ohms per volt. There are three voltmeter scales: the lowest range is from 0-5 volts. Voltages of the order of .1-volt may easily be read. The other voltmeter ranges are 0-50, 0-250 and 0-750 volts respectively. This gives a higher range and a better arrangement of intermediate scales than is available in most moderate price commercial ohmmeters.

The majority of commercial combination ohmmeters are merely volt-

(Continued on page 698)

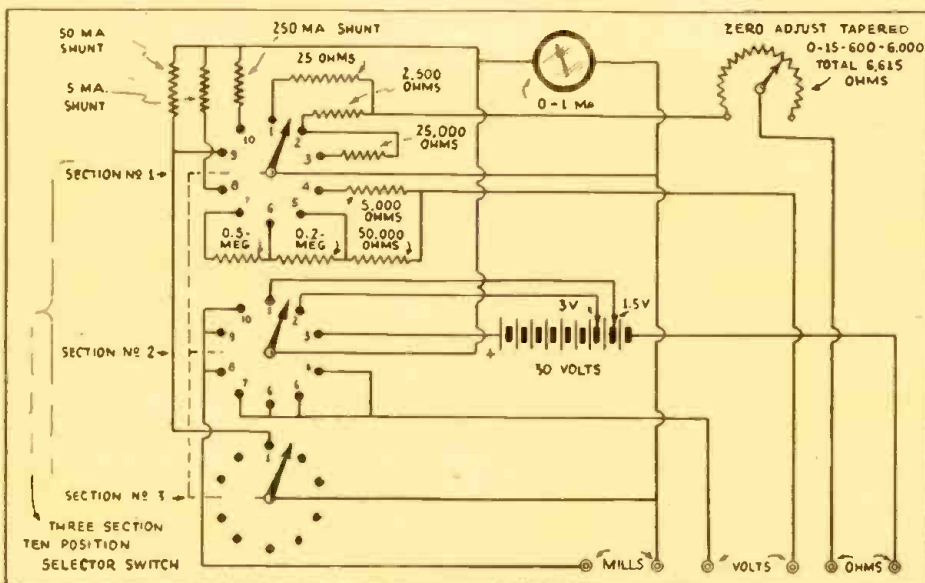

Above: Schematic circuit of the Multitester with the values of all parts. Note the use of a triple-pole rotary switch. Right: View of the rear of the tester. The simplicity is apparent at once.

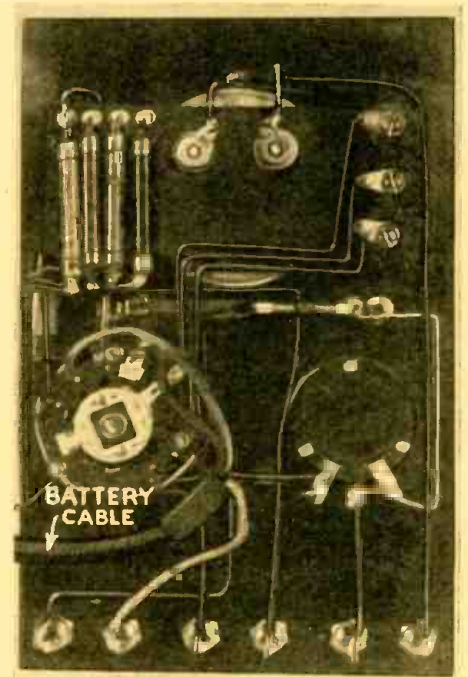

READERS' DEPARTMENT

A department in which the reader may convey his thoughts to other readers. Included in this department are letters, kinks, short cuts, and experiments. Send in your ideas.

THAT TABLE OF I. F.'s

Editor, RADIO-CRAFT:

I have been reading RADIO-CRAFT for some time. In the December, 1932 issue there appeared a chart of intermediate frequencies which took a load off most Service Men's minds. I want to thank you for this chart, and also for the RADIO-CRAFT tube chart which came out some time ago. Let's have more of these charts.

THEODORE CRITZON,
4633 Ellery,
Detroit, Mich.

(This is about the 'steenth letter we have received concerning these tables in RADIO-CRAFT. Thank you, kind Sirs. It seems that the service field greatly needed these useful tabulations. Any suggestions for more tables?—Editor)

TROUBLE IN A WINDSOR 70 S. G. SET

Due to the exceptional interest in a bit of recent correspondence, we print below the pros and cons of the discussion, which concerned the Windsor model 70 S. G. screen-grid T. R. F. set.
Editor, RADIO-CRAFT:

We have a Windsor model 70 S.G., 7 tube A.C., set (built by the National Transformer Co., of Chicago) which suddenly lost its volume, and the rectifier tube started to heat. We replaced one of the power pack condensers which was shorted and the volume came up to about two-thirds of what it was formerly on local stations, but all other stations can just be heard and the rectifier tube heats a little more than it used to. All voltages appear to be correct according to our set analyzer;

tubes all test good and we have aligned the condensers with an oscillator. We have sold and serviced sets for seven years, but this one has us stopped.

A. J. NORTHRUP & SON,
East Berne, N. Y.

To this communication we replied as follows:

Gentlemen:

The circuit of the Windsor receiver is not in our files.

Probably the simplest way to locate the trouble in this set is to isolate each section and to work in that section alone. That is, hook up the set with an external power pack (another Windsor, if available) and note the operation of the R.F. and detector section of the chassis. If this is O.K., try a different R.F. and detector unit (connected to the power pack of the Windsor under suspicion).

We are inclined to believe that you have a shorted bias resistor (although this should show up in the readings of your set analyzer). Of course, you have checked over your tubes. Test for correct grid bias voltages and operating plate currents. Do other sets work satisfactorily on the same aerial and ground? Check the filament voltage of every tube. Check all the condensers for leakage. Test all the resistors to make sure they are not shorted or open, and that they are of rated value.

Connect a microphone into the detector grid circuit of the set and note whether you get normal output from the reproducer when speaking into the mike. If not, check the detector and audio; never mind the R.F. If O.K., check the R.F. section of the chassis for accidental grounds.

Disconnect the power transformer connections and test the transformer for leakage of one of the windings to ground, or to each other. At the same time test each winding for rated output voltage. Try another reproducer; something may have happened to the present one.

You aligned the tuned stages with an oscillator. Did you get average readings on the meter in the plate circuit of the detector? (This is an instance of the value of working with calibrated equipment.) If you did not, look for leakage in coils or condensers (perhaps dust or soldering flux is in places where it does not belong). Leakage in the R.F. circuit could show up as reduced signal strength without the operating voltages being off in the least, but the old mike test would show that the trouble probably was in the R.F. chassis, as pointed out above. Put the aerial lead on the input to the detector, to check the operation of the R.F. circuits.

Do not miss one of these pointers.

Please advise us as to what you find to be wrong with the set.

RADIO-CRAFT
Technical Editor

The mystery was solved when we received the following letter.

Editor, RADIO-CRAFT:

The trouble was located in one of the condensers in the resistance coupled A.F. unit. This condenser tested O.K. until being "shot" with an extra high voltage, when it finally emitted a light curl of smoke. It must have been partially broken down and would alternately heal and break down. We re-

(Continued on page 683)

		TIME AND DAY CONVERSION TABLE																																															
		TODAY												TOMORROW																																			
Longitude	Place	12	13	14	15	16	17	18	19	20	21	22	23	24	1	2	3	4	5	6	7	8	9	10	11	12																							
EAST 180	Fiji Islands	11	12	13	14	15	16	17	18	19	20	21	22	23	24	1	2	3	4	5	6	7	8	9	10	11																							
165	New Zealand (4)	10	11	12	13	14	15	16	17	18	19	20	21	22	23	24	1	2	3	4	5	6	7	8	9	10																							
150	Australia, east	9	10	11	12	13	14	15	16	17	18	19	20	21	22	23	24	1	2	3	4	5	6	7	8	9	10																						
135	Japan	8	9	10	11	12	13	14	15	16	17	18	19	20	21	22	23	24	1	2	3	4	5	6	7	8	9	10																					
120	China, Philippines	7	8	9	10	11	12	13	14	15	16	17	18	19	20	21	22	23	24	1	2	3	4	5	6	7	8	9	10																				
105	Indo China, Straits Settlements	6	7	8	9	10	11	12	13	14	15	16	17	18	19	20	21	22	23	24	1	2	3	4	5	6	7	8	9	10																			
90	Calcutta (**)	5	6	7	8	9	10	11	12	13	14	15	16	17	18	19	20	21	22	23	24	1	2	3	4	5	6	7	8	9	10																		
75	Mauritius, Seychelles	4	5	6	7	8	9	10	11	12	13	14	15	16	17	18	19	20	21	22	23	24	1	2	3	4	5	6	7	8	9	10																	
60	Aden, Somaliland, Madagascar	3	4	5	6	7	8	9	10	11	12	13	14	15	16	17	18	19	20	21	22	23	24	1	2	3	4	5	6	7	8	9	10																
45	Germany, Italy, Norway, Sweden	2	3	4	5	6	7	8	9	10	11	12	13	14	15	16	17	18	19	20	21	22	23	24	1	2	3	4	5	6	7	8	9	10															
30	England, France, G.B.T.	1	2	3	4	5	6	7	8	9	10	11	12	13	14	15	16	17	18	19	20	21	22	23	24	1	2	3	4	5	6	7	8	9	10														
15		24	1	2	3	4	5	6	7	8	9	10	11	12	13	14	15	16	17	18	19	20	21	22	23	24	1	2	3	4	5	6	7	8	9	10													
0		23	24	1	2	3	4	5	6	7	8	9	10	11	12	13	14	15	16	17	18	19	20	21	22	23	24	1	2	3	4	5	6	7	8	9	10												
WEST 15		22	23	24	1	2	3	4	5	6	7	8	9	10	11	12	13	14	15	16	17	18	19	20	21	22	23	24	1	2	3	4	5	6	7	8	9	10											
30		21	22	23	24	1	2	3	4	5	6	7	8	9	10	11	12	13	14	15	16	17	18	19	20	21	22	23	24	1	2	3	4	5	6	7	8	9	10										
45	Brazil, east	20	21	22	23	24	1	2	3	4	5	6	7	8	9	10	11	12	13	14	15	16	17	18	19	20	21	22	23	24	1	2	3	4	5	6	7	8	9	10									
60	Argentina, Porto Rico	19	20	21	22	23	24	1	2	3	4	5	6	7	8	9	10	11	12	13	14	15	16	17	18	19	20	21	22	23	24	1	2	3	4	5	6	7	8	9	10								
75	Washington, D. C. E.S.T.	18	19	20	21	22	23	24	1	2	3	4	5	6	7	8	9	10	11	12	13	14	15	16	17	18	19	20	21	22	23	24	1	2	3	4	5	6	7	8	9	10							
90	Chicago, C.B.T.	17	18	19	20	21	22	23	24	1	2	3	4	5	6	7	8	9	10	11	12	13	14	15	16	17	18	19	20	21	22	23	24	1	2	3	4	5	6	7	8	9	10						
105	Denver, M.B.T.	16	17	18	19	20	21	22	23	24	1	2	3	4	5	6	7	8	9	10	11	12	13	14	15	16	17	18	19	20	21	22	23	24	1	2	3	4	5	6	7	8	9	10					
120	San Francisco, P.S.T.	15	16	17	18	19	20	21	22	23	24	1	2	3	4	5	6	7	8	9	10	11	12	13	14	15	16	17	18	19	20	21	22	23	24	1	2	3	4	5	6	7	8	9	10				
135		14	15	16	17	18	19	20	21	22	23	24	1	2	3	4	5	6	7	8	9	10	11	12	13	14	15	16	17	18	19	20	21	22	23	24	1	2	3	4	5	6	7	8	9	10			
150	Alaska	13	14	15	16	17	18	19	20	21	22	23	24	1	2	3	4	5	6	7	8	9	10	11	12	13	14	15	16	17	18	19	20	21	22	23	24	1	2	3	4	5	6	7	8	9	10		
165	Samoa, Hawaii (***)	12	13	14	15	16	17	18	19	20	21	22	23	24	1	2	3	4	5	6	7	8	9	10	11	12	13	14	15	16	17	18	19	20	21	22	23	24	1	2	3	4	5	6	7	8	9	10	
WEST 180		11	12	13	14	15	16	17	18	19	20	21	22	23	24	1	2	3	4	5	6	7	8	9	10	11	12	13	14	15	16	17	18	19	20	21	22	23	24	1	2	3	4	5	6	7	8	9	10

Fig. 1

A chart which indicates the time throughout the globe at any instant.

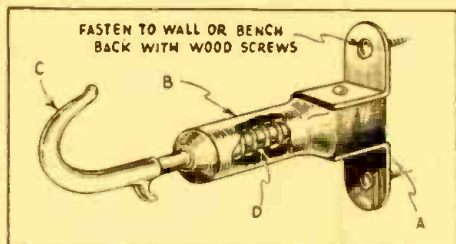

Fig. 3

A, bracket; B, hood; C, hook; D, internal spring.



Fig. 2

Here is an aligning tool that's easy to make.

THE ANALYSIS OF RADIO RECEIVER SYMPTOMS OPERATING NOTES

BERTRAM M. FREED

THE widespread use of automatic volume control and silent tuning control has made the servicing of radio receivers more difficult and complex. So many situations, both unique and troublesome, have arisen, due to different failures and defects in the A.V.C. and S.T.C. systems, that the Service Man is placed on his mettle. Schematic diagrams have been important in the past, but with the servicing of modern receivers, they have become vital. The careful study of a diagram with only a few tests has, in many instances, solved a knotty problem. Some of the situations will be described herein.

Atwater Kent Model 99

Some time ago, the complaint of "dead again" was received on an Atwater Kent model 99 receiver. The "again" conveyed the fact that the set had been serviced previously. Upon

arrival, the usual questions produced the information that the set made the same crackling noise at each of the three times it had ceased operating. A tube checker was plugged into the line and the chassis pulled out of the cabinet to test all the tubes as the first step toward clearing up the trouble. The set switch was snapped on to pre-heat the tubes.

Balancing the end of the chassis with one hand, an attempt was made to remove the control-grid cap of the first detector, 35 tube, with the free hand. An attempt was made, but failed, for when this was done, the author became the unfortunate donee of such a vicious "jolt," that any idea of further tube-checking was abandoned for the time being. The terminals of a voltmeter were placed from chassis to control grid of this tube and a reading of nearly 400 volts was obtained. The voltmeter disclosed a

similar voltage from the control grids of the R.F. and I.F. tubes, to chassis. This unusual situation caused no little conjecture, and the first thought was a primary-secondary short of either the R.F. or I.F. coils. However, if this were so, then, it was thought, some breakdown would result, as the plate voltage impressed on the primary would be short-circuited to ground or chassis through the secondary; but when the schematic was consulted, it was found that this condition of high voltage on the control grids of these three tubes was possible without further breakdown. The control-grid returns were connected in the A.V.C. circuit, together with the A.V.C. plate resistor; because of its high resistance, the amount of current was limited thereby preventing a short circuit of the entire voltage output.

The fact that there was no further breakdown evidenced an unimpaired

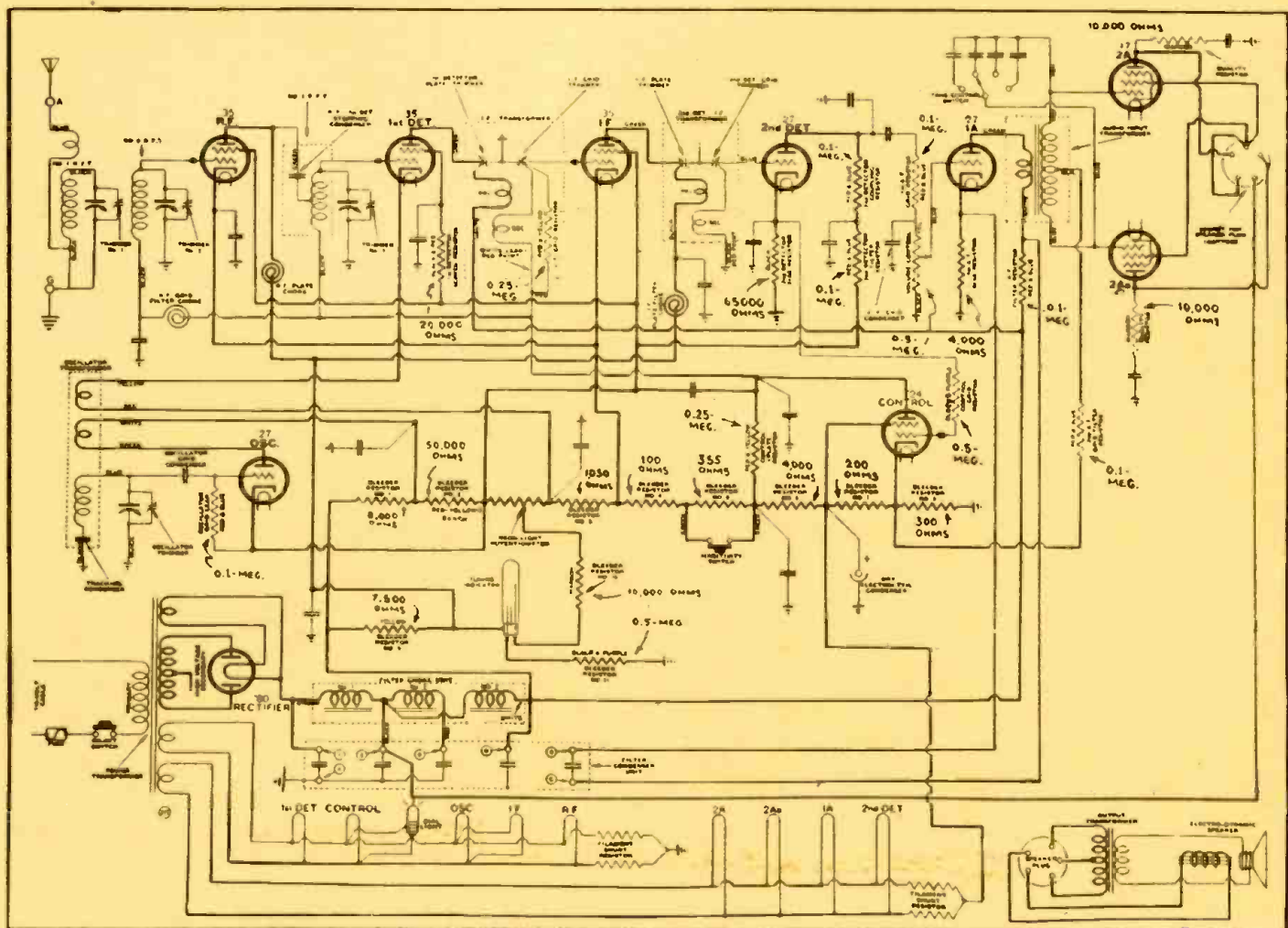

Fig. 1

Complete schematic circuit of the Atwater Kent model 99 receiver showing the values of all parts. An explanation of each unit is also included.

A.V.C. plate resistor, and, proceeding on this theory with the aid of a low-range ohmmeter, the short was found within the shield can of the first I.F. transformer, by the process of elimination. This unit is located in the extreme front right corner of the chassis and to the right of the control tube, a 24. When the shield of this transformer is removed (this may be easily done by pressing in the bottom of the can on two sides and then raising it), a carbon resistor will be seen imbedded in the pitch which is used to impregnate the primary of the I.F. coil. This resistor is shunted across the secondary winding, also impregnated, of the same unit. Whether due to vibration or other causes, the resistor short-circuits to the primary winding, resulting in the aforementioned condition of control grids that "kick."

To eliminate this defect, all that is necessary is to work the resistor out of the pitch and move it a fraction of an inch away, after wrapping a layer of tape around the unit. Another indication of this trouble will be the climbing of the neon tube glow to the top when the receiver is first switched on, then quickly falling to the bottom of the tube as the receiver tubes heat. The schematic of this receiver is illustrated in Fig. 1.

This same condition and effect has often been found on the model 96, the offending member being the secondary resistor within the first I.F. transformer. In this model, this resistor is located at the back right-hand corner of the chassis and in front of the neon light adjustment.

Atwater Kent 812

A few cases of noisy and intermittent reception have been reported on this model. This receiver is a new one, utilizing two type 83 rectifying tubes and type 46 tubes in the output stage with another 46 as a driver. In all of these few cases, the trouble has been traced to a loose connection beneath the sleeving of the wires connected to one end of the 1450 mmf. condenser within the oscillator coil shield.

On this same model, erratic operation of the silent tuning control has been found to be caused by a loose element in one of the 57 tubes in the S.T.C. stage. A few sharp taps on the glass envelope will soon disclose this condition; or, to more readily ascertain this fact, place the tube into one of the 58 sockets and repeat the tapping.

RCA Victor 21

An interesting case was recently encountered on an RCA Victor model 21 receiver: the complaint in this instance was fading. Following the usual procedure, the Service Man assigned to the job made a complete analysis of the receiver, checking the tubes at the same time, and a thorough inspection of the antenna system for possible breaks, grounds, or corroded connections. All was found ship-shape. The

WHAT THIS DEPARTMENT IS FOR

It is conducted especially for the professional Service Man. In it will be found the most unusual troubles encountered in radio service work, written, in a practical manner, by Service Men for you.

Have you, as a professional man, encountered any unusual or interesting Service Kink that may help your fellow workers? If so, let us have them. They will be paid for, upon publication, at regular space rates.

lady of the house offered the information that the fading usually occurred after the set had been operating for fifteen minutes or so. With this lead, the Service Man settled himself down to make what might be termed a "listening test."

With the volume control set for a moderate degree of volume, WOR, one of the most powerful and reliable broadcasters in the vicinity was tuned in. The receiver operated for forty-five minutes without the slightest variation in volume when the Service Man took his leave, the owner agreeing that the set was now apparently performing satisfactorily. However, after a few days, the same complaint was received. Another Service Man was dispatched with strict instructions to devote as much time as necessary to determine the true cause of the fading condition, should such exist.

On this occasion, the Service Man selected WJZ as the listening monitor and the receiver behaved perfectly for over two hours. The owner then volunteered the fact that he has never heard these powerful stations fade, and that it was only on the smaller stations at the high-frequency end of the scale that the volume varied. With this in mind, a 1280 kc. station was tuned in. This necessitated turning up the volume control. After only a few minutes, the fading commenced. The station selector was then set at 1350 kc. and the same condition persisted. On 1400 kc., however, where the volume control had to be turned back, the receiver did not fade.

To negative any idea of faulty padding or trimmer condensers, the dial was turned to 600 kc., a distant station, and the signal faded. This led to only one conclusion; the volume control was at fault. When this control was turned to the highest point, or, on the higher end, the slightest touch or vibration would cause the arm to shift from one turn on the resistor to the next. It was near the end of the resistor, where the winding was least firmly moored, that this shift became noticeable, resulting in the fading. An odd complaint, but after a new unit had been installed, the fading condition was remedied. Subsequently, two other receivers of the same model appeared with similar complaints, which, because of the first, were speedily rectified.

On this same model, many service calls have been made because of slipping drive cables. A very simple arrangement is utilized on this receiver, and although the trouble may be caused by a stretched tension spring, which does not take up sufficient slack in the cable, it has been found that by taking another turn around the gang shaft, sufficient friction is obtained to clear up the difficulty. This may be done by releasing the spring beneath the dial, so that the turn may be made with the loose cable. The spring is then fastened into position and the dial restored to

(Continued on page 684)

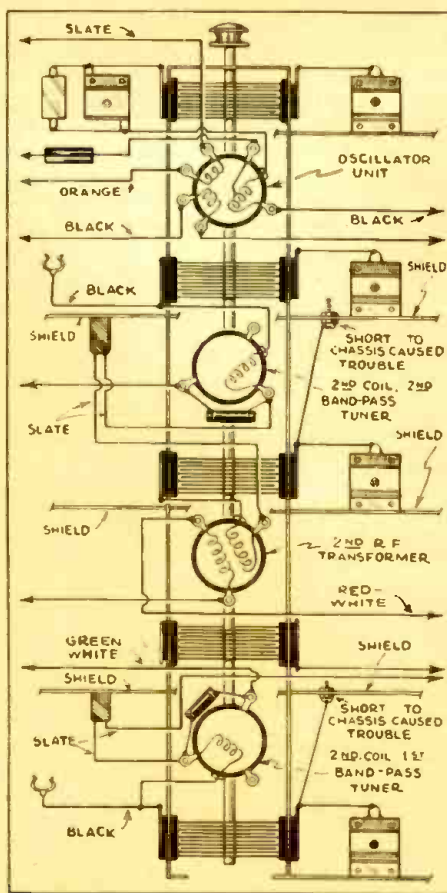

Fig. 3

Detail of the tuning units and shields in the Stromberg Carlson models 25 and 26 receivers. The screws, shown above, were shorted to the chassis, causing the volume to drop and the tuning dial readings to shift about twenty-five kilocycles.

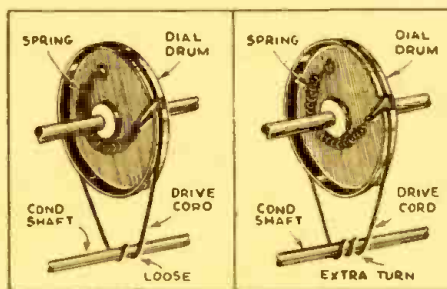

Fig. 2

Slipping cables are not an uncommon trouble on many sets. In the RCA Victor model 21 receiver, this trouble may be remedied by loosening the spring and taking an extra turn around the condenser shaft—not the dial shaft.

REWIRING RCA AND A. K. SETS FOR 2-VOLT TUBES

DAVID HOYLE

A practical description of the manner in which RCA and A.K. receivers have been rewired for two-volt operation. It is completely illustrated by diagrams.

THE list price of the 22 is 80 per cent higher than that of the 32 (in Canada), and in that comparison lies an opportunity for the Service Man.

The RCA 22 is a five-tube battery set originally using two 22's and three 12A's (or two 12A's and one 71A). Replacing the 22's with 32's is a comparatively simple operation in this set. The owner saves money and the Service Man paves the way for a complete change to five, two-volt tubes and a little extra revenue. With two 32's, two 30's, and one 31 in place of the original layout, the total filament drain is cut to approximately one-third of its former value. This means, not only less cost for battery charging, but, in the case of an owner located at a distance from a garage or radio service station, less inconvenience, since every battery charge means trouble, and perhaps one or two days without reception.

Installing 2-Volt Tubes

Take out the chassis and turn it over; have the back edge toward you. Near the center of the nearer edge is a flat resistance strip (R1 in Fig. 1A). This strip is the bias resistor of 6.5 ohms for the two R. F. tubes. It is grounded at one end. Disconnect the lead at the

grounded end and insert an additional resistor of 6 ohms at X1, grounding, of course, the free end. See Fig. 2. We make these resistors of nichrome wire wound on a fibre strip; No. 28 wire has a resistivity of 4.25 ohms to the foot. Allow a few extra inches above that required, so that a little may be added in the circuit if necessary on final voltage test. From 1.5 to 2 volts is the best all-around bias found in our experience, and the added resistance is sufficient.

At the left-hand end of the same edge of the set are two resistance strips side by side; each is 1.95 ohm (R2 and R3). A yellow lead, A+ in the cable, is soldered to the junction of the two. Through one of these resistors, R3, flows the current for the power tube and the two R.F. tubes. Make sure you have the correct one by tracing the lead (black) to the filament socket of the power tube. Take a 1-ohm fixed resistor and short out one-quarter of it. Insert this resistor between the end of the resistance strip and the power-tube socket (at X2). When the 32's replace the 22's, the total current flowing through this resistance is reduced from 514 ma. to 370 ma., and the 1. volt drop required (for power tube 5-volt circuit) is given by the increased resistance. From the plus post on the power

socket to which this lead is connected, two black leads through the chassis lead to the plus filaments of the R.F. tubes. Break each (at X3 and X4) and insert a 25 ohm grid suppressor or a home wound resistance strip, 25 ohms each.

Using a fully charged storage battery and an accurate voltmeter, make a careful test of all filament voltages. Minor adjustments are taken care of by the extra length left available in the bias resistor. (This bias is not critical.) Rebalance the set.

The voltage amplification factor of these newer tubes is given as 440 as against 300 for the 22. Both owners, for whom we have made the change, believe it an improvement. One of these owners, for whom we made the change eight months ago, and who keeps a careful check of his storage battery charging, insists that he is getting 30% or more extra service from the one charge though only the R.F.'s have been changed and the three 12A's are still in use. We judge this to be due, possibly, to the greater sensitivity of the 32 when the battery is below normal charge.

Little difficulty should be met in making the change. The leads are easy to trace, no "wrecking" of the chassis is required, and there is ample room for the added resistance strips.

Changing the Audio End of the Set

When the time comes to change the audio and detector ends, proceed as follows: remove the three-quarter ohm resistor previously inserted at X2 and replace with one of two ohms. This assumes the use of a 31 in the power stage (Filament drain, .13-amp.), therefore, four ohms (very nearly) in this lead gives the required one-volt drop. (Total filament current is to be .13-plus .12-amp., for 32's, which will give the required one-volt drop through the four ohms.) Thus, changes in the previously added R.F. resistors are not needed. In series with the other 1.95 ohm resistance, R2, shown in Fig. 1A, add an additional six ohms. The total resistance, now eight ohms and the .12-amp. for the two 30's (detector and first audio), gives a one-volt drop. *Now we need three volts drop for each of these last three tubes.* Fifty-ohm grid suppressor (test them) for the plus leg of both detector and first audio tubes will supply this. For the 31, a 25-ohm resistor is a bit high, but can be "doctored" if required. As before, test

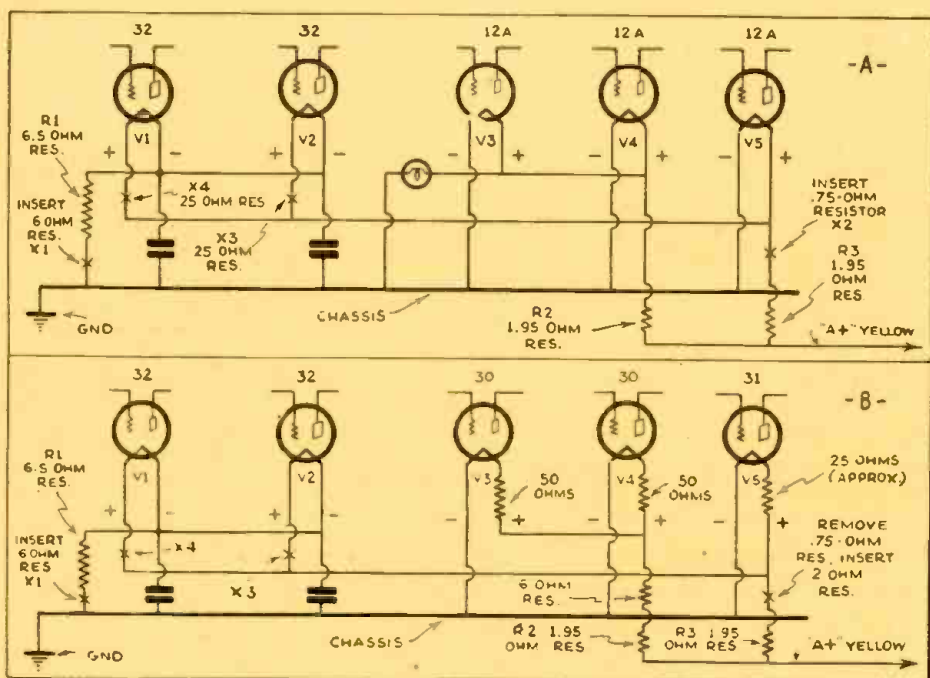

Fig. 1

Schematic of the RCA 22 with only the R.F. end of the set changed at A; at B, the same set showing the changes for complete two-volt operation.

everything carefully. We do not think it wise to follow the original schematic and use a single resistor for two tubes; better give each tube a resistor of its own, otherwise, if one blows, the other may follow suit. A diagram showing the changes to be made to alter the audio end is shown in Fig. 1B.

The owner of one of these sets complained of harshness at high volume but did not care to use the 71A with its added "B" drain. We added a .002-mf. fixed condenser in parallel with the one already across the secondary of the first audio transformer and he was pleased. The 12A was retained.

When inserting the resistor in the plus lead of the detector tube, be careful to disconnect the pilot-lamp lead. Run a direct connection to yellow "A" plus and use a 6-volt lamp.

Changing A. K. Type "Q" Chassis for 2-Volt Tubes

We have changed the R.F. end of the two Atwater-Kent Model Q chassis for 2-volt tubes. This is a seven tube battery set originally using three 22's in the R.F. end. We have only replaced the 22's in the R.F. end, leaving the audio end alone.

Remove the shields and tubes, and turn the chassis over. Remove the bottom cover plate. With the R.F. end to your left, you will note that near the front edge (away from you) of the chassis a short yellow-covered wire leading direct from the minus on the first audio to a grounded lug on the detector socket. This lead is carrying the filament current of the detector and audio tubes to ground. This lead need not be changed as the R.F. filament currents return to ground by other paths. Attached to the filament posts of the R.F. sockets will be seen the R.F. filament resistors and the R.F. bias resistors; they are long, thin, covered wires, black with white tracer. Remove them. They will be replaced by resistors (25- and 50-ohm suppressors) as indicated in Fig. 3. Break the wire connecting the first audio filament plus to the third R.F. filament plus at B (Figs. 3 and 4). Insert a six ohm resistor. This resistor will carry the current for the three R.F. tube filaments, .18-amp., and there will be a one-volt drop here. Now insert the 25- and 50-ohm suppressors as shown in Fig. 4. Note that the new resistance schematic follows the original one.

It is best to wind the six-ohm resistor inserted at B. Allow a little extra, as in the previous job. This will take care of any final adjustment. Of course, this resistor could be dispensed with, but we had a bunch of 25- and 50-ohm resistors and used them in this way.

Both these sets carry a tremendous punch and we had no trouble with oscillation. A third chassis of the same type required a 500-ohm grid suppressor in third grid lead. We are experimenting with the full 50-ohm in the negative leg of first and second R.F. tube, in turn (perhaps both), and hope to dispense with the suppressor in the grid lead. Both sets mentioned have been in continuous use five months.

REWIRING OLD RECEIVERS FOR NEW TUBES

"New tubes have made my old set obsolete," cries the owner of a two-year old radio. "How can I bring it up-to-date?" he pleads in the same voice. These and many other similar questions pour into the editorial offices of this publication every day.

Our policy in answering such letters is to state that we are unable to forward design data by mail; but, if we should secure same, we shall be pleased to publish it. We take this stand because we are not desirous of indulging in pure theoretical speculations; and, furthermore, when we give information, we want to be sure that it is correct. The practical Service Man will appreciate this viewpoint, we are sure.

This article is an example of the type of information we want to publish along these lines. Therefore, if you, as a Service Man, have actually rewired receivers for use with new tubes, send in your manuscript with all information. Details of the manner in which manuscripts are to be prepared will be mailed upon request.

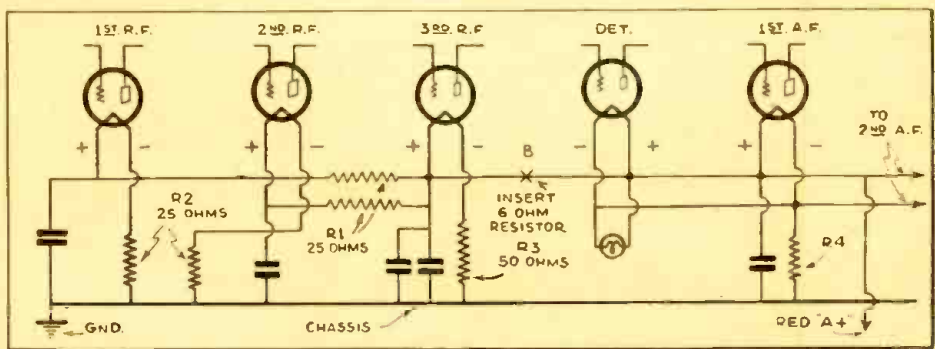

Fig. 3
Circuit indicating the changes to be made in rewiring the A.K. "Q" chassis.

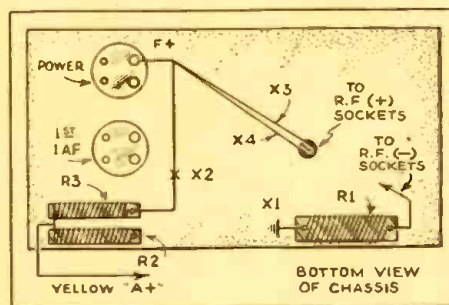

Fig. 2, above

Pictorial layout of the receiver showing the location of all parts necessary for the conversion of the R.F. end of the set. Note R1, R2, and R3.

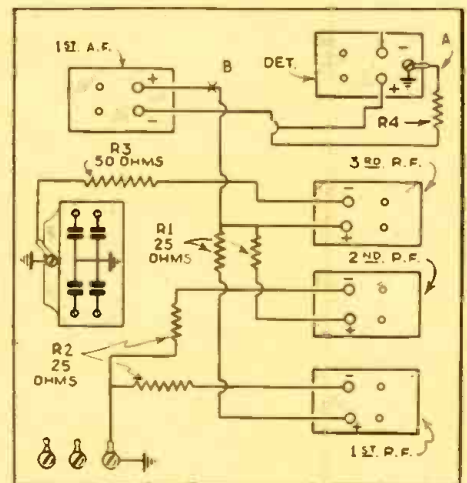

Fig. 4, right

Diagram showing the location of the resistors to be used in changing the A.K. "Q" chassis for two-volt operation. Also, see Fig. 3, above.

R.C.A. VICTOR R-27 AND PHILCO 53 ULTRA-MIDGET A.C.-D.C. RADIO RECEIVERS

R.C.A. Victor R-27 Universal

This small radio set carries the following specifications: Line voltage rating, 105 to 120 V., D.C., or 25 to 133 cycles A.C. Power consumption, 40 W. A feature of this set is the extremely wide tuning range of 540 to 1,700 kc. Operating voltages at maximum volume, on a 115 V. A.C. line (on D.C., slightly less) are as follows:

Tube Type	Fil. Volts	C.-G. Volts	S.-G. Volts	Plate Volts	Plate Ma.
1	6.0	3.0	105	105	7
2	6.0	0.75*	11.0	60*	.025
3	6.0	11.0	100	95	5
4	6.0	-----	-----	115	15

*Impossible to measure on ordinary voltmeter.

The left-hand knob is a combined volume control and power switch; the station selector is at the right. If the set does not work within a minute, reverse the position of the line plug in the socket. This particular type of set should be so positioned as to permit full ventilation at all times.

The most satisfactory length of aerial for this set is to be determined by individual trial. In general, a length of about 20 ft. should be quite sufficient; this length is the dimension of the lead which is supplied with the set. If the antenna lead is bunched, or coiled, too near the set, circuit oscillation may occur. A similar effect may be produced if the volume control is advanced too far. When tuned to a local station with the volume control fully advanced, a condition may be observed where a certain amount of counter-clockwise rotation of the control will improve the quality of reproduction and actually increase the volume. This condition is caused by overloading and may be corrected simply by setting the volume control below the readily-apparent critical point.

Philco 53 Universal Compact

Operating voltages at a line potential of 120 V., D.C., are given below:

Tube Type	Fil. Volts	C.-G. Volts	S.-G. Volts	Cath. Volts	Plate Volts
V1	7	94	18	95	
V2	4	34	12	15	
V3	4	102	10	94	
V4	-----	-----	112	112	

V1	*	8	93	7-14	95
V2	*	3	34	6-12	14
V3	*	4	100	3-26	94
V4	*	---	---	58-73	10

*The total voltage applied to the filaments is 51 V.

All of these readings were taken from the underside of the chassis, using test prods and leads with a suitable high resistance meter; the volume control is set at maximum and the station selector at 550 kc.

The following data concerning the operation of this set on 115 V. A.C. are furnished:

Tube Type	Fil. Volts	C.-G. Volts	S.-G. Volts	Cath. Volts	Plate Volts
V1	7	94	18	95	
V2	4	34	12	15	
V3	4	102	10	94	
V4	-----	-----	112	112	

*The total voltage applied to the filaments is 49.9 V.

These readings are taken in the manner described for making D.C. tests.

To obtain maximum sensitivity through the use of the 30 ft. of antenna wire furnished with the set, it will be necessary to adjust the antenna compensating condenser, the L.F. compensating condenser and the sensitivity condenser in the following manner; unroll the 30 ft. of antenna wire to its full length (do not connect it to another aerial or ground while the following adjustments are being made). Tune to a station near the H.F. end of the dial (between 1400 and 1500 kc.). With a fibre adjusting wrench, adjust the antenna condenser for maximum volume. (This condenser is the second one from the front control.) After this is completed, tune to a station near the L.F. end of the dial (as near 600 kc. as possible) and then adjust the L.F. condenser for maximum volume (looking at the back of the set, this is the unit at the extreme left); retune to the H.F. station and do any necessary fine readjusting so as to bring in the station with maximum volume.

Now check the adjustment of the sensitivity condenser (at the immediate right of the L.F. condenser) with the receiver tuned to a station near the H.F. end of the dial; turn this condenser to the right as far as possible without causing circuit oscillation or a squeal. Repeat this adjustment on a station near the L.F. end of the dial; if circuit oscillation occurs, turn the condenser to the left until this disappears.

At the rear of the chassis are four condenser controls, as follows (starting from the left): L.F. condenser; sensitivity; I.F. primary, 450 kc.; and I.F. secondary, 450 kc.

Of exceptional interest is the use of the new, type 77 tube, the externally-connected suppressor-grid 6.3 V. R.F. pentode. The type 12Z3 rectifier has a 12 V. filament. The second-detector, V2, is made slightly regenerative at the I.F. In order to secure adequate filtration on A.C. circuits, the single filter-choke has connected to it not only the usual input and output filter condensers, but also a shunt tuning condenser which, with the choke coil, forms a trap circuit. The chassis does not connect directly to the light line.

The filter condenser bank is color coded as follows: Black, common; green, .09-mf.; white, .25-mf.; red, .75-mf.; black and white, 0.2-mf.; the common lead connects to the shield can only through a condenser of .05-mf.

The fiber screw at the back of the chassis should be adjusted at the time of installation. Place the set in operation, tune in a station near the middle of the dial, and adjust this screw, which controls the regeneration condenser, C until, by turning clockwise, a swishing sound is heard where different stations are tuned in. Now turn the screw counter-clockwise until the swishing sound just ceases. Continue to turn in the same direction about one-quarter turn. When correctly adjusted, the circuit will not break into oscillation at any point in the tuning range.

As indicated in the schematic circuit, several changes have been incorporated in models starting with run 5.

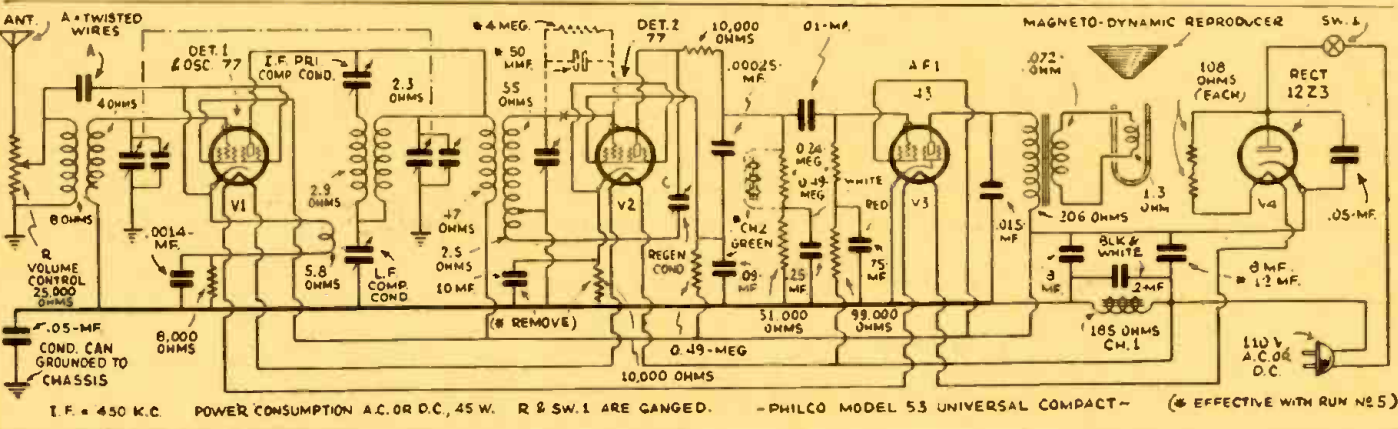
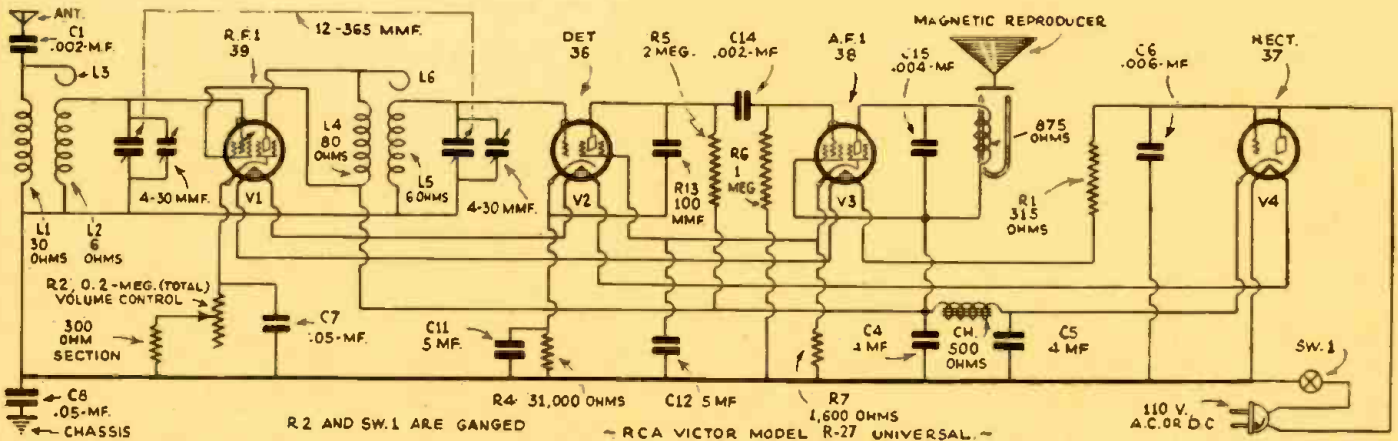

FADA 103 FADALETTE, STEWART-WARNER SERIES 108, AND DE WALD 54 DYNETTE SETS

Fada 103 Fadalette

A tabulation of voltages in this set on D.C.:

Tube Type	Fil. Volts	C.-G. Volts	S.-G. Volts	Plate Volts	Plate Ma.
V1	6.3	2.5	97.5	97.5	4.5
V2	6.3	---	7.5	---	---
V3	6.3	7.5	92.5	95.5	4.8
V4	2.5	---	---	---	37

A set of figures for A.C. line operation:

Tube Type	Fil. Volts	C.-G. Volts	S.-G. Volts	Plate Volts	Plate Ma.
V1	6.3	2.6	110	110	6
V2	6.3	---	9	---	---
V3	6.3	9	104	102	7
V4	6.3	---	---	---	40

The D.C. and A.C. readings are for a 110 V. line. Bias readings are taken across respective bias resistors. The D.C. input is 34 W., and the A.C., 36 W.

Stewart-Warner Companion Chassis Series 108 and 108-X, Models 10 to 20
With the volume control tuned full on, the

following approximate voltages should be read to the frame of unit C. (using a high resistance voltmeter).

Tube Type	Fil. Volts	Cath. Volts	S.G. Volts	Plate Volts
V1	6.3	1.5	107	107
V2	6.3	1.3	9	1.3
V3	6.3	9	107	103
V4	12.6	122	---	---

These figures are for a 115 v. A.C. line; on D.C., the values will be slightly lower.

Circuit oscillation may be due to the antenna being too close to the set; oscillation at low signal volume with maximum set sensitivity is normal. The power cord is naturally warm. Do not force V4 into its socket. This set is designed to be operated on 110, 32, 12, or 6 V. current-supply systems.

Pierce-Airo De Wald Model 54 Dynette
The following tabulation of operating voltages is furnished by the manufacturer:

Tube Type	Fil. Volts	C.-G. Volts	S.-G. Volts	Plate Volts	Plate Ma.
V1	6.3	2.15	103	103	2
V2	6.3	3	9	39	.1
V3	6.3	9	103	98	10
V4, V5	6.3	---	---	---	15

By means of suitable line resistors, or adapters, this set may be operated on light-line or battery power.

All sets of the "universal current" type now on the market require that the Service Man check the position of the power plug in its socket to determine whether it is correctly poled. It is seldom that the chassis frame connects directly to the power line. Circuit oscillation at the high-sensitivity setting of the volume control is normal in many models. The results obtained with ultra-midget sets will greatly depend upon local reception conditions.

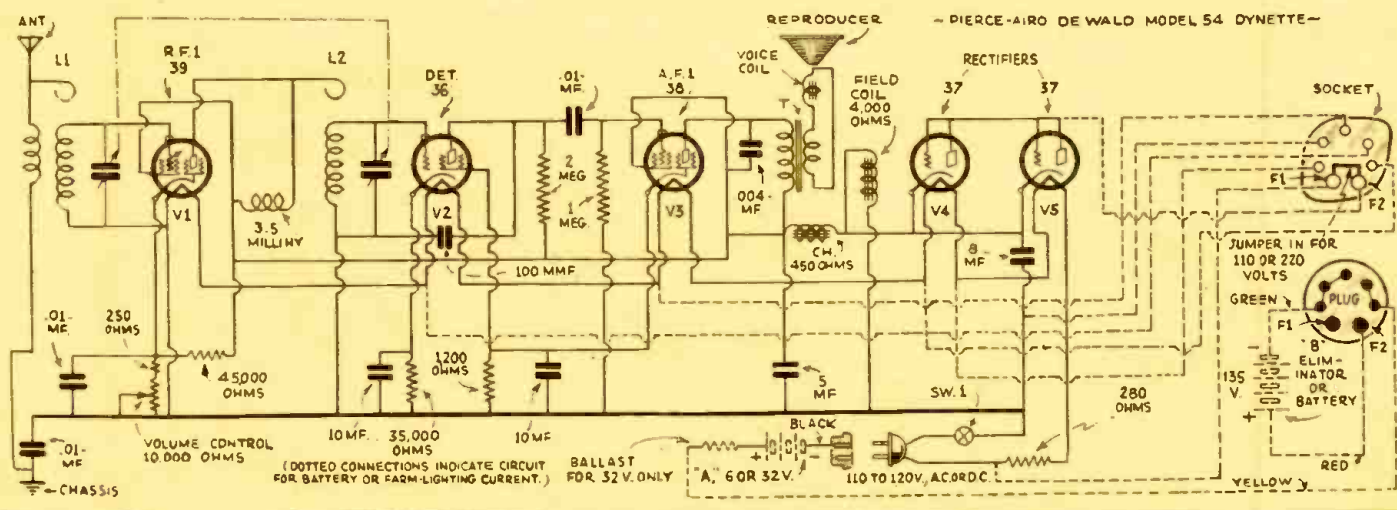
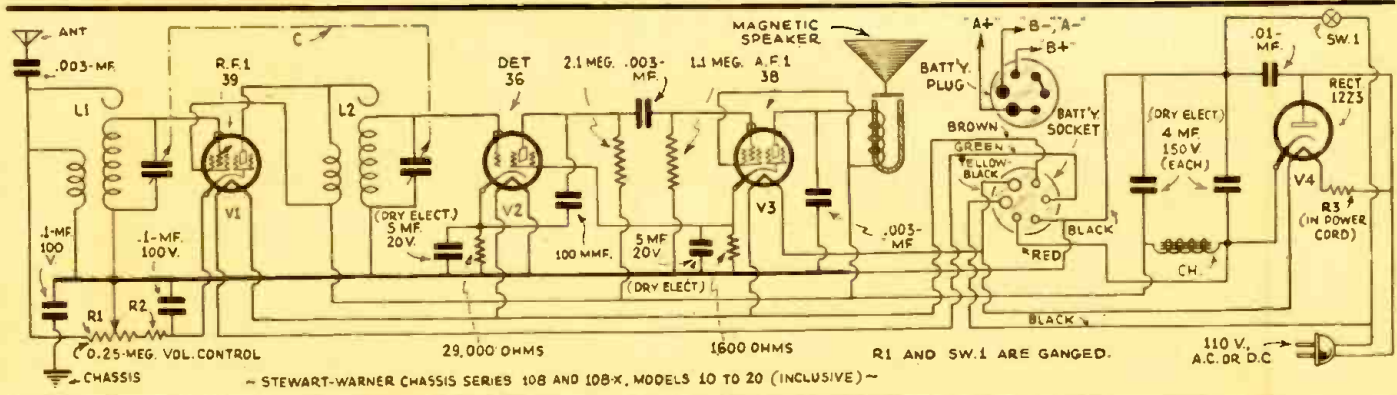
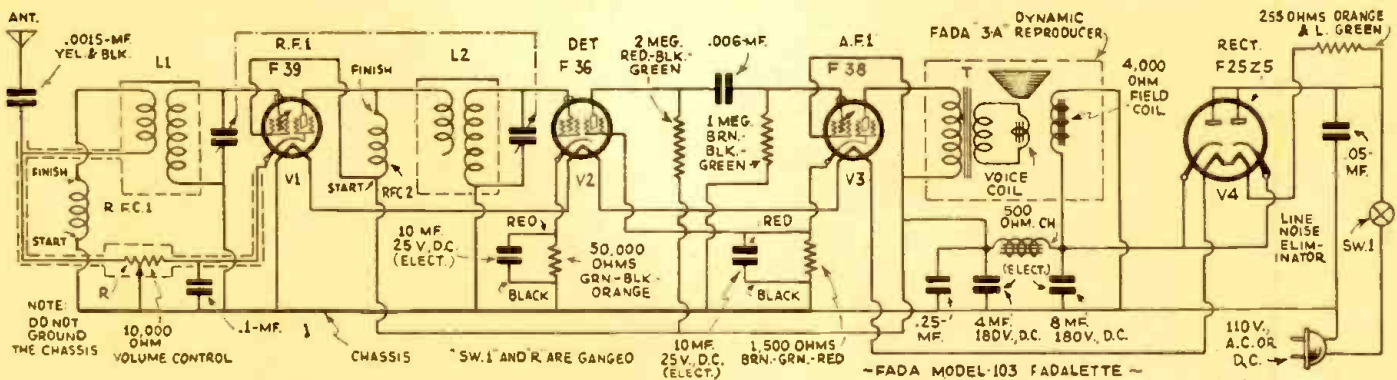

BROADCAST STATIONS OF THE U. S.

A list of all the broadcast stations in the U. S. as prepared by the Bureau of Standards. Abbreviations: T, location of transmitter; C. P., construction permit authorized; LS, power until local sunset. There is no wave-length table; the wave-length, however, may be computed from the frequency in kilocycles (kc.) by dividing 300,000 by the frequency in kilocycles. Thus, station KALE, operating on a frequency of 1,300 kc., has a wavelength of 300,000 divided by 1300, or about 230 meters.

Call Letters	Location	Power (watts)	Freq. kc.	Call Letters	Location	Power (watts)	Freq. kc.	Call Letters	Location	Power (watts)	Freq. kc.
KABC	San Antonio, Tex.	100	1420	KGDE	Fergus Falls, Minn.	100	1200	KOIL	Council Bluffs, Iowa	1kw	1260
KALE	Portland, Ore.	500	1300	KGDM	Stockton, Calif.	250	1100	KOIN	Portland, Ore.	1kw	940
KARK	Little Rock, Ark.	250	890	KGDY	Huron, S. D.	100	1200		T-Sylvan		
KASA	Elk City, Okla.	100	1210	KGEF	Los Angeles, Calif.	1kw	1300	KOL	Seattle, Wash.	1kw	1270
KBPS	Portland, Ore.	100	1420	KDEK	Yuma, Colo.	100	1200	KOMA	Oklahoma City, Okla.	5kw	1480
KBTM	Paragould, Ark.	100	1200	KGER	Long Beach, Calif.	1kw	1360	KOMO	Seattle, Wash.	1kw	920
KCMC	Texarkana, Ark.	100	1420	KGEW	Ft. Morgan, Colo.	100	1200	KONO	San Antonio, Tex.	100	1370
KCRC	Enid, Okla.	100	1370	KGEZ	Kalispell, Mont.	100	1310	KOOS	Marshfield, Ore.	100	1370
KCRJ	Jerome, Ariz.	100	1310	KGFF	Shawnee, Okla.	100	1420	KORE	Eugene, Ore.	100	1420
KDB	Santa Barbara, Calif.	100	1500	KGFG	Oklahoma City, Okla.	100	1370	KOY	Phoenix, Ariz.	500	1390
KDFN	Casper, Wyo.	500	1440	KGFI	Corpus Christi, Tex.	100	1500	KPCB	Seattle, Wash.	100	650
KDKA	Pittsburgh, Pa.	50kw	980	KGFI	Los Angeles, Calif.	100	1200	KPJM	Prescott, Ariz.	100	1500
	T-Saxonburg			KGFK	Moorhead, Minn.	50	1500	KPO	San Francisco, Calif.	5kw	680
KDLR	Devils Lake, N. D.	100	1210	KGFL	Raton, N. Mex.	50	1370		C.P.T.-Near San Mateo	C.P.50kw	
KDYL	Salt Lake City, Utah	1kw	1290		C. P. Roosevelt			KPOF	Denver, Colo.	500	880
KECA	Los Angeles, Calif.	1kw	1430	KGFW	Kearney, Nebr.	100	1310	KPPC	Pasadena, Calif.	50	1210
KELW	Burbank, Calif.	500	780	KGFX	Pierre, S. D.	200	630	KPQ	Wenatchee, Wash.	50	1500
KERN	Bakersfield, Calif.	100	1200	KGGC	San Francisco, Calif.	100	1420	KPRC	Houston, Tex.	1kw	920
KEX	Portland, Ore.	5kw	1180	KGGF	Coffeyville, Kans.	500	1010		T-Sugarland	2 1/2 kw-LS	
KFAB	Lincoln, Nebr.	5kw	770		T. South Coffeyville, Okla.			KQV	Pittsburgh, Pa.	500	1380
KFAC	Los Angeles, Calif.	1kw	1300	KGGM	Albuquerque, N. M.	250	1230	KQW	San Jose, Calif.	500	1010
KFBB	Great Falls, Mont.	1kw	1280	KGHF	Pueblo, Colo.	250	1320	KRE	Berkeley, Calif.	100	1370
KFBI	Abilene, Kans.	5kw	1050	KGHI	Little Rock, Ark.	100	1200	KREG	Santa Ana, Calif.	100	1500
	T-Milford			KGHL	Billings, Mont.	1kw	950	KRGV	Harlingen, Tex.	500	1260
KFBK	Sacramento, Calif.	100	1310	KGIR	Butte, Mont.	500	1360	KRKD	Los Angeles, Calif.	500	1120
KFBL	Everett, Wash.	50	1370	KGIW	Trinidad, Colo.	100	1420	KRLD	Dallas, Tex.	10kw	1040
KFDM	Beaumont, Texas	500	560	KGIX	Las Vegas, Nev.	100	1420	KRMD	Shreveport, La.	100	1310
KFOY	Brookings, S. D.	1kw	550	KGIZ	Grant City, Mo.	100	1500	KROW	Oakland, Calif.	500	930
KFEL	Denver, Colo.	500	920	KGKB	Tyler, Tex.	100	1500		T-Richmond	1kw-LS	
	T-Edgewater			KGKL	San Angelo, Tex.	100	1370	KRSC	Seattle, Wash.	100	1120
KFEQ	St. Joseph, Mo.	2 1/2 kw	680	KGKO	Wichita Falls, Tex.	250	570	KSAC	Manhattan, Kans.	500	580
KFGQ	Boone, Iowa	100	1310	KGKX	Sandpoint, Idaho.	100	1420	KSCJ	Sioux City, Iowa	1kw	1330
KFH	Wichita, Kans.	1kw	1300		C. P. Lewiston			KSD	St. Louis, Mo.	500	550
KFI	Los Angeles, Calif.	50kw	640	KGKY	Scottsbluff, Nebr.	100	1500	KSEI	Pocatello, Idaho	250	890
	T-Buena Park			KGMB	Honolulu, Hawaii	250	1320	KSL	Salt Lake City, Utah	50kw	1130
KFIO	Spokane, Wash.	100	1120	KGMP	Elk City, Okla.	100	1210		T-Saltair		
KFIZ	Fond du Lac, Wis.	100	1420	KGNF	North Platte, Nebr.	500	1430	KSO	Des Moines, Iowa	100	1370
KFJB	Marshalltown, Iowa	100	1200	KGNO	Dodge City, Kans.	100	1210	KSOO	Sioux Falls, S. D.	2 1/2 kw	1110
KFJI	Klamath Falls, Ore.	100	1210	KGO	San Francisco, Calif.	7 1/2 kw	790	KSTP	St. Paul, Minn.	10kw	1480
KFJM	Grand Forks, N. D.	100	1370		T-Oakland				T-Radio Center		
KFJR	Portland, Ore.	500	1300	KGRS	Amarillo, Tex.	1kw	1410	KTAB	San Francisco, Calif.	1kw	560
KFJZ	Fort Worth, Tex.	100	1370	KGU	Honolulu, Hawaii	2 1/2 kw	750	KTAR	T-Oakland		
KFKA	Greeley, Colo.	500	880	KGVO	Missoula, Mont.	100	1200	KTAT	Phoenix, Ariz.	500	620
KFKU	Lawrence, Kan.	500	1220	KGW	Portland, Ore.	1kw	620		Fort Worth, Tex.	1kw	1240
	T-Tonganoxie				T-Faloma			KTBS	T-Birdville		
KFKX	(See KYW-KFKX)			KGX	Olympia, Wash.	100	1210	KTFI	Shreveport, La.	1kw	1450
KYW				KHJ	Los Angeles, Calif.	1kw	900	KTHS	Twin Falls, Idaho	500	1240
KFLV	Rockford, Ill.	500	1410	KHQ	Spokane, Wash.	1kw	590		Hot Springs National Park, Ark.	10kw	1040
KFLX	Galveston, Tex.	100	1370	KICA	Clovis, N. M.	100	1370	KTM	Los Angeles, Calif.	500	780
KFMX	Northfield, Minn.	1kw	1250	KICK	Red Oak, Iowa.	100	1420		T-Santa Monica	1kw-LS	
KFNF	Shenandoah, Iowa	500	890	KID	Idaho Falls, Idaho.	250	1320	KTRH	Houston, Tex.	500	1120
KFOR	Lincoln, Nebr.	100	1210	KIDW	Boise, Idaho.	1kw	1350	KTSA	San Antonio, Tex.	1kw	1290
KFOX	Long Beach, Calif.	1kw	1250	KIEM	Lamar, Colo.	100	1420	KTSM	El Paso, Tex.	100	1310
KFPL	Dublin, Tex.	100	1310	KIEV	Eureka, Calif.	100	1210	KTW	Seattle, Wash.	1kw	1220
KFPM	Greenville, Tex.	15	1310	KIFH	Glendale, Calif.	100	850	KUJ	Walla Walla, Wash.	100	1370
KFPW	Ft. Smith, Ark.	100	1210	KIT	Juneau, Alaska	100	1310	KUMA	Yuma, Ariz.	100	1420
KFPY	Spokane, Wash.	1kw	1340	KJBS	Yakima, Wash.	100	1310	KUOA	Fayetteville, Ark.	1kw	1390
KFQD	Anchorage, Alaska	250	1230	KJR	San Francisco, Calif.	100	1070	KUSD	Vermillion, S. D.	500	890
KFRC	San Francisco, Calif.	1kw	610	KJRN	Seattle, Wash.	5kw	970	KVI	Tacoma, Wash.	500	570
KFRU	Columbia, Mo.	500	630	KLCN	Blytheville, Ark.	50	1290		T-Des Moines		
KFSD	San Diego, Calif.	1kw	600	KLO	Ogden, Utah	500	1400	KVL	Seattle, Wash.	100	1370
KFSG	Los Angeles, Calif.	500	1120	KLPM	Minot, N. D.	250	1240	KVOA	Tucson, Ariz.	500	1260
KFUL	Galveston, Tex.	500	1290	KLRA	Little Rock, Ark.	1kw	1390	KVOO	Tulsa, Okla.	5kw	1140
KFUO	Clayton, Mo.	500	550	KLS	Oakland, Calif.	250	1440	KVOR	Colorado Springs, Colo.	1kw	1270
KFVD	Los Angeles, Calif.	250	1000	KLX	Oakland, Calif.	500	880	KVOS	Bellingham, Wash.	100	1200
KFVS	Cape Girardeau, Mo.	100	1210	KLZ	Denver, Colo.	1kw	560	KWCR	Cedar Rapids, Iowa	100	1420
KFWB	Hollywood, Calif.	1kw	950	KMA	Shenandoah, Iowa	500	930	KWEA	Shreveport, La.	100	1210
KFWF	St. Louis, Mo.	100	1200	KMAC	San Antonio, Texas	100	1370	KWG	Stockton, Cal.	100	1200
KFWI	San Francisco, Calif.	500	930	KMBC	Kansas City, Mo.	1kw	950	KWJJ	Portland, Ore.	500	1060
KFXD	Nampa, Idaho	100	1200		T-Independence			KWK	St. Louis, Mo.	1kw	1350
KFXF	Denver, Colo.	500	920	KMED	Medford, Ore.	100	1310		T-Kirkwood		
KFXJ	Grand Junction, Colo.	100	1200	KMJ	Fresno, Calif.	100	1210	KWKC	Kansas City, Mo.	100	1370
KFXM	San Bernardino, Calif.	100	1210					KWKH	Shreveport, La.	10kw	850
KFXR	Oklahoma City, Okla.	100	1310	KMLB	Monroe, La.	100	1200		T-Kennonwood		
KFYO	Lubbock, Tex.	100	1310	KMMJ	Clay Center, Neb.	1kw	740	KWLC	Decorah, Iowa	100	1270
KFYR	Bismarck, N. D.	1kw	550	KMO	Tacoma, Wash.	250	1330	KWSC	Pullman, Wash.	1kw	1220
KGA	Spokane, Wash.	5kw	1470	KMOX	St. Louis, Mo.	50kw	1090	KWWG	Brownsville, Tex.	500	1260
KGAR	Tucson, Ariz.	100	1370	KMPC	Beverly Hills, Calif.	500	710	KXA	Seattle, Wash.	250	760
KGB	San Diego, Calif.	1kw	1330	KMTR	Los Angeles, Calif.	500	570	KXL	Portland, Ore.	100	1420
KGBU	Ketchikan, Alaska	500	900	KNOW	Austin, Tex.	100	1500	KXO	El Centro, Calif.	100	1500
KGBX	Springfield, Mo.	100	1310	KNX	Los Angeles, Calif.	25kw	1050	KXRO	Aberdeen, Wash.	100	1310
KGBZ	York, Nebr.	500	930	KOA	Denver, Colo.	12 1/2 kw	830	KXYZ	Houston, Tex.	250	1440
KGCA	Decorah, Iowa	100	1270	KOAC	Corvallis, Ore.	1kw	550	KYA	San Francisco, Calif.	1kw	1230
KGCR	Watertown, S. D.	100	1210	KOAB	Albuquerque, N. M.	10kw	1180	KYW	Chicago, Ill.	10kw	1020
KGCU	Mandan, N. D.	250	1240	KOCW	Chickasha, Okla.	250	1400	KFKX	T-Bloomington Townsp.		
KGCX	Wolf Point, Mont.	100	1310	KOH	Reno, Nev.	500	1380	WAAB	Boston, Mass.	500	1410
KGDA	Mitchell, S. D.	100	1370								

Call Letters	Location	Power (watts)	Freq. kc.	Call Letters	Location	Power (watts)	Freq. kc.	Call Letters	Location	Power (watts)	Freq. kc.
WAAF	T-Quincy			WDAE	Tampa, Fla.	1kw	1220	WHAT	Philadelphia, Pa.	100	1310
WAAM	Chicago, Ill.	500	920	WDAF	Kansas City, Mo.	1kw	610	WHAZ	Troy, N. Y.	500	1300
WAAT	Newark, N. J.	1kw	1250	WDAJ	Amarillo, Tex.	1kw	1410	WHB	Kansas City, Mo.	500	860
WAAX	Jersey City, N. J.	300	940	WDAH	El Paso, Tex.	100	1310	WHBC	T-North Kansas City		
WABC	Omaha, Nebr.	500	660	WDAS	Philadelphia, Pa.	100	1370	WHBD	Canton, Ohio	10	1200
WBOQ	New York, N. Y.	50kw	860	WDAY	Fargo, N. D.	1kw	940	WHBF	Mt. Orab, Ohio	100	1370
WABI	T-Wayne, N. J.			WDBJ	T-West Fargo			WHBL	Rock Island, Ill.	100	1210
WABO	Bangor, Maine	100	1200	WDBO	Roanoke, Va.	250	930	WHBQ	Sheboygan, Wis.	500	1410
WHEC	(See WHEC-WABO)			WDEL	Orlando, Fla.	250	580	WHBU	Memphis, Tenn.	100	1370
WABZ	New Orleans, La.	100	1200	WDEI	Wilmington, Del.	250	1120	WHBY	Anderson, Ind.	100	1210
WACO	Waco, Tex.	1kw	1240	WDGY	Waterbury, Vt.	500	550		Green Bay, Wis.	100	1200
WADC	Tallmadge, Ohio	1kw	1320	WDDO	Minneapolis, Minn.	1kw	1180	WHDF	T-West De Pere		
WAGM	Presque Isle, Maine	100	1420	WDRC	Chattanooga, Tenn.	1kw	1280	WHDH	Calumet, Mich.	100	1370
WAIU	Columbus, Ohio	500	640	WDSU	T-Brainard	2 1/2 kw-LS		WHDL	Boston, Mass.	1kw	830
WALR	Zanesville, Ohio	100	1210	WDZ	Hartford, Conn.	500	1330	WHOL	T-Saugus		
WAMC	Anniston, Ala.	100	1420	WEAF	T-Bloomfield			WHOB	Tupper Lake, N. Y.	100	1420
WAPI	Birmingham, Ala.	5kw	1140	WEAN	New Orleans, La.	1kw	1250	WHOB	Portsmouth, N. H.	250	740
WASH	Grand Rapids, Mich.	500	1270	WEAO	T-Gretna			WHOC	T-Newington		
WAWZ	Zarephath, N. J.	250	1350	WEBC	Tuscola, Ill.	100	1070	WHOB	Rochester, N. Y.	500	1440
WAZL	Hazleton, Pa.	100	1420	WEBC	New York, N. Y.	50kw	660	WHOF			
WBAA	W. Lafayette, Ind.	500	1400	WEBC	T-Bellmore			WHOF	Kosciusko, Miss.	100	1500
WBAK	Harrisburg, Pa.	500	1430	WEBC	Providence, R. I.	250	780	WHOF	Troy, Ala.	100	1210
WBAL	Baltimore, Md.	10kw	1060	WEBC	Columbus, Ohio	750	570	WHFC	Cicero, Ill.	100	1420
WBAP	T-Glen Morris			WEBC	Superior, Wis.	1kw	1290	WHIS	Bluefield, W. Va.	250	1410
WBAP	Fort Worth, Tex.	50kw	800	WEBC	Harrisburg, Ill.	100	1210	WHK	Cleveland, Ohio	1kw	1390
WBAX	T-Grapevine			WEBC	Buffalo, N. Y.	100	1310	WHK	T-Seven Hills	2 1/2 kw-LS	
WBAX	Wilkes-Barre, Pa.	100	1210	WEBC	Chicago, Ill.	100	1210	WHN	New York, N. Y.	250	1010
WBAX	T-Plains Twp.			WEBC	Boston, Mass.	1kw	590	WHO	Des Moines, Iowa	5kw	1000
WBC	Brooklyn, N. Y.	500	1400	WEBC	T-Weymouth			WHOM	Jersey City, N. J.	250	1450
WBBL	Richmond, Va.	100	1210	WEBC	Reading, Pa.	1kw	830	WHP	Harrisburg, Pa.	500	1430
WBMM	Chicago, Ill.	25kw	770	WEBC	Emory, Va.	500	1350	WHP	T-Lemoine	1kw-LS	
WJBT	T-Glenview			WEBC	Cicero, Ill.	100	1420	WIAS	Ottumwa, Iowa	100	1310
WBBR	Brooklyn, N. Y.	1kw	1300	WEBC	Battle Creek, Mich.	50	1420	WIBA	Madison, Wis.	500	1280
WBBZ	T-Rossville			WEBC	Americus, Ga.	100	1420	WIBG	Glenside, Pa.	25	930
WBBZ	Ponca City, Okla.	100	1200	WENR	Chicago, Ill.	50kw	870	WIBM	T-Elkins Park		
WBCM	Bay City, Mich.	500	1410	WBCN	T-Downers Grove			WIBM	Jackson, Mich.	100	1370
WBCM	T-Hampton Twp.			WBCN	(See WORC-WEPS)			WIBO	Chicago, Ill.	1kw	560
WBCN	(See WENR-WBCN)			WEPB				WIBO	T-Des Plaines	1 1/2 kw-LS	
WENR				WERE	Erie, Pa.	100	1420	WIBU	Poynette, Wis.	100	1210
WBEN	Buffalo, N. Y.	1kw	900	WESG	Elmira, N. Y.	1kw	1040	WIBW	Topeka, Kans.	1kw	580
WBEO	T-Martinsville			WEVD	T-Ithaca			WIBX	Utica, N. Y.	100	1200
WBES	Marquette, Mich.	100	1310	WEVD	New York, N. Y.	500	1300	WICC	Bridgeport, Conn.	250	600
WBIG	Huntsville, Ala.	100	1200	WEVD	T-Brooklyn			WICC	T-Easton	500-LS	
WBIS	Greensboro, N. C.	500	1440	WEVD	St. Louis, Mo.	1kw	760	WIL	St. Louis, Mo.	100	1200
WBIS	(See WNAC-WBIS)			WEVD	Royal Oak, Mich.	50	1310	WILL	Urbana, Ill.	250	890
WNAC				WEVD	Dallas, Tex.	50kw	800	WILM	Wilmington, Del.	100	1420
WBMS	Haekensack, N. J.	250	1450	WEVD	T-Grapevine			WINS	T-Edge Moor		
WBNS	New York, N. Y.	250	1350	WEVD	New York, N. Y.	1kw	1300	WINS	New York, N. Y.	500	1180
WBOQ	(See WABC-WBOQ)			WEVD	T-Carlstadt, N. J.			WIOD	T-Astoria, L. I.		
WABC				WEVD	South Bend, Ind.	100	1200	WIOD	Miami, Fla.	1kw	1300
WBOW	Terre Haute, Ind.	100	1310	WEVD	Philadelphia, Pa.	500	610	WMBF	T-Miami Beach		
WBRC	Birmingham, Ala.	500	930	WEVD	White Plains, N. Y.	100	1210	WIP	Philadelphia, Pa.	500	610
WBRE	Wilkes-Barre, Pa.	100	1310	WEVD	Greenville, S. C.	100	1200	WIS	Columbia, S. C.	500	1010
WBSS	Needham, Mass.	500	920	WEVD	Cincinnati, Ohio	100	1200	WISN	Milwaukee, Wis.	250	1120
WBT	Charlotte, N. C.	25kw	1080	WEVD	Altoona, Pa.	100	1310	WJAC	Johnstown, Pa.	100	1310
WBTM	Danville, Va.	100	1370	WEVD	Syracuse, N. Y.	1kw	1360	WJAG	Norfolk, Nebr.	1kw	1060
WBZ	Boston, Mass.	25kw	990	WEVD	T-Collamer	2 1/2 kw-LS		WJAR	Providence, R. I.	250	890
WBZ	T-Millis Twp.			WEVD	Indianapolis, Ind.	1kw	1230	WJAS	Pittsburgh, Pa.	1kw	1290
WBZ	Boston, Mass.	1kw	990	WEVD	Baltimore, Md.	500	1270	WJAS	T-North Fayette, Twp.	2 1/2 kw-LS	
WBZ	T-East Springfield			WEVD	Flint, Mich.	100	1310	WJAX	Jacksonville, Fla.	1kw	900
WCAC	Storrs, Conn.	250	600	WEVD	Rome, Ga.	100	1500	WJAY	Cleveland, Ohio	500	610
WCAD	Canton, N. Y.	500	1220	WEVD	Manchester, N. H.	500	1430	WJBC	La Salle, Ill.	100	1200
WCAE	Pittsburgh, Pa.	1kw	1220	WEVD	Philadelphia, Pa.	500	560	WJBI	Red Bank, N. J.	100	1210
WCAH	Columbus, Ohio	500	1430	WEVD	Hopkinsville, Ky.	1kw	940	WJBI	Detroit, Mich.	50	1370
WCAJ	Lincoln, Nebr.	500	590	WEVD	Clearwater, Fla.	250	620	WJBL	T-Highland Park		
WCAL	Northfield, Minn.	1kw	1250	WEVD				WJBL	Decatur, Ill.	100	1200
WCAM	Camden, N. J.	500	1280	WEVD	Brooklyn, N. Y.	500	1400	WJBO	New Orleans, La.	100	1420
WCAD	Baltimore, Md.	250	600	WEVD	Lancaster, Pa.	100	1310	WJBT	C.P. Baton Rouge		
WCAP	Asbury Park, N. J.	500	1280	WEVD	Cleveland, Ohio	500	1450	WJBT	(See WBBM-WJBT)		
WCAT	T-Whitesville			WEVD	T-Cuyahoga Heights	1kw-LS		WBBM			
WCAT	Rapid City, S. D.	100	1200	WEVD	Freeport, N. Y.	100	1210	WJBU	Lewisburg, Pa.	100	1210
WCAU	Philadelphia, Pa.	50kw	1170	WEVD	(See WNBR-WGBC)			WJBU	New Orleans, La.	100	1200
WCAU	T-Newton, Square Co.			WEVD				WJBW	Gadsden, Ala.	100	1210
WCAZ	Burlington, Vt.	100	1200	WEVD	Evansville, Ind.	500	630	WJBY	Jackson, Miss.	1kw	1270
WCAZ	Carthage, Ill.	50	1070	WEVD	Seranton, Pa.	250	880	WJBY	Hagerstown, Md.	100	1210
WCBA	Allentown, Pa.	250	1440	WEVD	Mississippi City, Miss.	100	1210	WJBY	Tupelo, Miss.	500	990
WCBD	Zion, Ill.	5kw	1080	WEVD	Newark, N. J.	250	1250	WJBY	Williamsport, Pa.	100	1370
WCBM	Baltimore, Md.	100	1370	WEVD	Chicago, Ill.	500	1360	WJBY	Mooseheart, Ill.	20kw	1130
WCBS	Springfield, Ill.	100	1210	WEVD	Newport News, Va.	100	1310	WJBY	Gary, Ind.	1kw	1360
WCCO	Minneapolis, Minn.	50kw	810	WEVD	Ft. Wayne, Ind.	100	1370	WJBY	Ironwood, Mich.	100	1420
WCCO	T-Anoka			WEVD	Glens Falls, N. Y.	50	1370	WJBY	Detroit, Mich.	10kw	750
WCCO	New York, N. Y.	250	1350	WEVD	C.P. Hudson Falls	C.P. 100-LS		WJBY	T-Sylvan Lake Village		
WCCO	T-Cliffside, N. J.			WEVD	See WLB-WGMS)			WJBY	Alexandria, Va.	10kw	1460
WCFL	Chicago, Ill.	1 1/2 kw	970	WEVD				WJBY	T-Mt. Vernon Hills		
WCGU	Brooklyn, N. Y.	500	1400	WEVD	Chicago, Ill.	25kw	720	WJBY	C.P. Near Alexandria, Va.		
WCKY	T-Long Island City			WEVD	T-Elgin			WJBY	Oglethorpe University, Ga.	100	1370
WCKY	Covington, Ky.	5kw	1490	WEVD	Chester Township, N. Y.	50	1210	WJBY	T-Atlanta		
WCKY	T-Crescent Springs			WEVD	Buffalo, N. Y.	1kw	550	WJBY	Akron, Ohio	100	1210
WCLO	Janesville, Wis.	100	1200	WEVD	T-Amherst			WJBY	New York, N. Y.	30kw	760
WCLO	Joliet, Ill.	100	1310	WEVD	Atlanta, Ga.	250	890	WJBY	T-Bound Brook, N. J.		
WCOA	Pensacola, Fla.	500	1340	WEVD	Schenectady, N. Y.	50kw	790	WJBY	San Juan, P. R.	1kw	1240
WCOC	Meridian, Miss.	500	880	WEVD	T-South Schenectady			WKAQ	E. Lansing, Mich.	1kw	1040
WCOD	Harrisburg, Pa.	100	1200	WEVD	Madison, Wis.	750	940	WKAR	Laconia, N. H.	100	1310
WCOR	Chicago, Ill.	100	1210	WEVD	Milwaukee, Wis.	250	1120	WKAR	Joliet, Ill.	100	1310
WCSC	Charleston, S. C.	500	1360	WEVD	Rochester, N. Y.	5kw	1150	WKBB	C.P. E. Dubuque	C.P. 1500	
WCSH	Portland, Me.	1kw	940	WEVD	T-Victor Twp.	C.P. 25kw		WKBC	Birmingham, Ala.	100	1310
WCSH	T-Scarboro	2 1/2 kw-LS		WEVD	Louisville, Ky.	25kw	820	WKBF	Indianapolis, Ind.	500	1400
WCSH				WEVD	T-Jefferson town			WKBF	T-Clermont		

Call Letters	Location	Power (watts)	Freq. kc.	Call Letters	Location	Power (watts)	Freq. kc.	Call Letters	Location	Power (watts)	Freq. kc.
WKBH	C.P. T-Nr. Indianapolis			WNBH	New Bedford, Mass.	100	1310	WRDW	Augusta, Ga.	100	1500
WKBI	La Crosse, Wis.	1kw	1380	WNBO	T-Fairhaven	250-LS		WREC-	Memphis, Tenn.	500	600
WKBN	Cicero, Ill.	100	1420	WNBZ	Silverhaven, Pa.	100	1200	WOAN	T-Whitehaven	1kw-LS	
WKBS	Youngstown, Ohio	500	570	WNBZ	Memphis, Tenn.	500	1430	WREN	Lawrence, Kans.	1kw	1220
WKBV	Galesburg, Ill.	100	1310	WNBZ	Carbondale, Pa.	10	1200	WRHM	T-Tonganoxie		
WKBW	Connersville, Ind.	100	1500	WNBZ	Springfield, Vt.	250	1260		Minneapolis, Minn.	1kw	1250
	Buffalo, N. Y.	5kw	1480	WNBZ	Saranac Lake, N. Y.	50	1290	WRJN	T-Fridley		
	T-Amherst			WNBZ	Newark, N. J.	250	1450	WRNY	Racine, Wis.	100	1370
WKBZ	Ludington, Mich.	100	1500	WNBZ	Knoxville, Tenn.	1kw	560		New York, N. Y.	250	1010
WKFI	Greenville, Miss.	100	1210	WNBZ	New York, N. Y.	500	570	WROL	T-Coytesville, N. J.		
WKJC	Lancaster, Pa.	100	1200	WNBZ	San Antonio, Tex.	50kw	1190	WRR	Knoxville, Tenn.	100	1310
WKRC	Cincinnati, Ohio	500	550	WNBZ	T-Selma			WRUF	Dallas, Tex.	500	1280
WKY	Oklahoma City, Okla.	1kw	900	WNBZ	(See WREC-WOAN)			WRVA	Gainesville, Fla.	5kw	830
WKZO	Kalamazoo, Mich.	1kw	590	WOAN-					Richmond, Va.	5kw	1110
WLAC	Nashville, Tenn.	5kw	1470	WREC				WSAI	T-Mechanicsville		
WLAP	Louisville, Ky.	100	1200	WOAX	Trenton, N. J.	500	1280		Cincinnati, Ohio	500	1330
WLB-	Minneapolis, Minn.	1kw	1250	WOBW	Charleston, W. Va.	250	580		T-Mason	1kw-LS	
WGMs	T-St. Paul			WOC	Davenport, Iowa	5kw	1000	WSAJ	Grove City, Pa.	100	1310
WLBC	Muncie, Ind.	50	1310	WOCL	Jamestown, N. Y.	50	1210	WSAN	Allentown, Pa.	250	1440
WLBF	Kansas City, Kans.	100	1420	WODA	Paterson, N. J.	1kw	1250	WSAR	Fall River, Mass.	250	1450
WLBL	Stevens Point, Wis.	2kw	900	WODX	Mobile, Ala.	500	1410	WSAZ	Huntington, W. Va.	250	580
	T-Nr. Ellis				T-Springhill			WSB	Atlanta, Ga.	5kw	740
WLBW	Erie, Pa.	500	1260	WOI	Ames, Iowa	5kw	640	WSBC	Chicago, Ill.	100	1210
	T-Summit Township	1kw-LS		WOKO	Albany, N. Y.	500	1440	WSBT	South Bend, Ind.	500	1230
WLBZ	Bangor, Me.	500	620	WOL	Washington, D. C.	100	1310	WSEN	Columbus, Ohio	100	1210
WLCI	Ithaca, N. Y.	50	1210	WOMT	Monticore, Wis.	100	1210	WSFA	Montgomery, Ala.	500	1410
WLEY	Lexington, Mass.	100	1370	WOOD	Grand Rapids, Mich.	500	1270	WSIX	Springfield, Tenn.	100	1210
WLIB-	(See WGN-WLIB)			WOPI	Bristol, Tenn.	100	1500	WSJS	Winston-Salem, N. C.	100	1310
WGN				WOQ	Kansas City, Mo.	1kw	1300	WSM	Nashville, Tenn.	50kw	650
WLIT	Philadelphia, Pa.	500	560	WOR	Newark, N. J.	5kw	710		T-Franklin		
WLOE	Boston, Mass.	100	1500		T-Kearny	C.P. 50kw		WSMB	New Orleans, La.	500	1320
	T-Chelsea	250-LS		WORC-	Worcester, Mass.	100	1200	WSMK	Dayton, Ohio	200	1380
WLS	Chicago, Ill.	50kw	870	WPEs	T-Auburn			WSOC	Gastonia, N. C.	100	1210
	T-Downers Grove			WORK	York, Pa.	1kw	1000	WSPA	Spartanburg, S. C.	100	1420
WLTH	Brooklyn, N. Y.	500	1400		T-W. Manchester			WSPD	Toledo, Ohio	1kw	1340
WLVA	Lynchburg, Va.	100	1370	WOS	Jefferson City, Mo.	500	630	WSUI	Iowa City, Iowa	500	880
WLW	Cincinnati, Ohio	50kw	700	WOV	New York, N. Y.	1kw	1130	WSUN-	(See WFLA-WSUN)		
	T-Mason				T-Secaucus, N. J.			WFLA			
WLWL	New York, N. Y.	5kw	1100	WOW	Omaha, Neb.	1kw	590	WSVS	Buffalo, N. Y.	50	1370
	T-Kearny, N. J.			WOWO	Ft. Wayne, Ind.	10kw	1180	WSYB	Rutland, Vt.	100	1500
WMAC-	(See WSYR-WMAC)			WPAD	Padueneh, Ky.	100	1420	WSYR-	Syracuse, N. Y.	250	570
WSYR				WPAP-	(See WQAO-WPAP)			WMAC			
WMAL	Washington, D. C.	250	630	WQAC				WTAD	Quincy, Ill.	500	1440
WMAQ	Chicago, Ill.	5kw	670	WPAP-	(See WPRO-WPAP)			WTAG	Worcester, Mass.	250	580
	T-Addison			WPRO				WTAM	Cleveland, Ohio	50kw	1070
WMAS	Springfield, Mass.	100	1420	WPCC	Chicago, Ill.	500	540		T-Brecksville Village		
WMAZ	Macon, Ga.	500	1180	WPCH	New York, N. Y.	500	810	WTAQ	Eau Claire, Wis.	1kw	1330
WMBC	Detroit, Mich.	100	1420		T-Flushing				T-Twp. of Washington		
WMBD	Peoria, Ill.	500	1440	WPEN	Philadelphia, Pa.	100	1500	WTAR-	Norfolk, Va.	500	780
	T-Peoria Heights	1kw-LS		WPFB	Hattiesburg, Miss.	100	1370	WPOR			
WMBF-	(See WIOD-WMBF)			WPG	Atlantic City, N. J.	5kw	1100	WTAW	College Station, Tex.	500	1120
WIOD				WPHR	Petersburg, Va.	100	1200	WTAX	Springfield, Ill.	100	1210
WMBG	Richmond, Va.	100	1210		T-Ettrick			WTBO	Cumberland, Md.	100	1420
WMBH	Joplin, Mo.	100	1420	WPOR-	(See WTAR-WPOR)			WTEL	Philadelphia, Pa.	100	1310
WMBI	Chicago, Ill.	5kw	1080	WTAR	Providence, R. I.	100	1210	WTFI	Athens, Ga.	500	1450
	T-Addison			WPRO-				WTIC	Hartford, Conn.	50kw	1060
WMBO	Auburn, N. Y.	100	1310	WPAW	T-Cranston				T-Avon		
WMBQ	Brooklyn, N. Y.	100	1500	WPFT	Raleigh, N. C.	1kw	680	WTJS	Jackson, Tenn.	100	1310
WMBR	Tampa, Fla.	100	1370	WQAM	Miami, Fla.	1kw	560	WTMJ	Milwaukee, Wis.	1kw	620
WMC	Memphis, Tenn.	500	780	WQAN	Seranton, Pa.	250	880		T-Brookfield	2 1/2kw-LS	
	T-Bartlett	1kw-LS		WQAO	New York, N. Y.	250	1010	WTOC	Savannah, Ga.	500	1260
WMCA	New York, N. Y.	500	570	WPAP	T-Cliffside, N. J.			WTRC	Elkhart, Ind.	50	1310
	T-Flushing			WQBC	Vicksburg, Miss.	500	1360	WTSL	Laurel, Miss.	100	1310
WMIL	Brooklyn, N. Y.	100	1500	WQDM	St. Albans, Vt.	100	1370	WWAE	Hammond, Ind.	100	1200
WMMN	Fairmont, W. Va.	250	890	WQDX	Thomasville, Ga.	100	1210	WWJ	Detroit, Mich.	1kw	920
WMPC	Lapeer, Mich.	100	1500	WRAK	Williamsport, Pa.	100	1370	WWL	New Orleans, La.	10kw	850
WMSG	New York, N. Y.	250	1350	WRAM	Wilmington, N. C.	100	1370		T-Kenner		
WMT	Waterloo, Iowa	500	600	WRAW	Reading, Pa.	100	1310	WWNC	Asheville, N. C.	1kw	570
WNAC-	Boston, Mass.	1kw	1230	WRAX	Philadelphia, Pa.	250	1020	WRRL	Woodside, N. Y.	100	1500
WBIS	T-Quincy			WRBL	Columbus, Ga.	100	1200	WRSW	Pittsburgh, Pa.	100	1500
WNAD	Norman, Okla.	500	1010	WRBX	Roanoke, Va.	250	1410		T-Wilkinsburg	250-LS	
WNAX	Yankton, S. D.	1kw	570	WRC	Washington, D. C.	500	950	WWVA	Wheeling, W. Va.	5kw	1160
WNBf	Binghamton, N. Y.	100	1500	WRDO	Augusta, Me.	100	1370	WXYZ	Detroit, Mich.	1kw	1240

POLICE STATIONS ALPHABETICALLY BY CALL LETTERS

Call Letters	Location	Freq. kc.	Call Letters	Location	Freq. kc.	Call Letters	Location	Freq. kc.	Call Letters	Location	Freq. kc.
KGHO	Des Moines, Iowa	1534	KGPX	Denver, Colo.	2442	WPDH	Richmond, Ind.	2442	WKDU	Cincinnati, Ohio	1712
KGJX	Pasadena, Calif.	1712	KGPY	Shreveport, La.	1574	WPDI	Columbus, Ohio	2430	WMDZ	Indianapolis, Ind.	2442
KGOZ	Cedar Rapids, Iowa	2470	KGPZ	Wichita, Kans.	2450	WPDS	St. Paul, Minn.	2416	WMJ	Buffalo, N. Y.	2422
KGPA	Seattle, Wash.	2414	KGZB	Houston, Tex.	1712	WPDW	Washington, D. C.	2422	WMO	Highland Park, Mich.	2414
KGPB	Minneapolis, Minn.	2416	KGZC	San Diego, Calif.	2430	WPDY	Detroit, Mich.	2414	WMP	Framingham, Mass.	1574
KGPC	St. Louis, Mo.	1712	KGZE	San Antonio, Tex.	2506	WPDX	Atlanta, Ga.	2414	WPKK	Milwaukee, Wis.	2450
KGPD	San Francisco, Calif.	2470	KGZF	Chanute, Kans.	2450	WPEA	Syracuse, N. Y.	2458	WPOL	Lansing, Mich.	2442
KGPE	Kansas City, Mo.	2422	KGZH	Klamath Falls, Ore.	2442	WPEV	Grand Rapids, Mich.	2442	WPDM	Dayton, Ohio	2430
KGPG	Vallejo, Calif.	2422	KGZI	Wichita Falls, Tex.	1712	WPEC	Memphis, Tenn.	2470	WPDN	Auburn, N. Y.	2458
KGPH	Oklahoma City, Okla.	2450	KGZM	El Paso, Tex.	2414	WPEE	New York, N. Y.	2450	WPDO	Akron, Ohio	2458
KGPI	Omaha, Neb.	2470	KVP	Dallas, Tex.	1712	WPEF	New York, N. Y.	2450	WPDP	Philadelphia, Pa.	2470
KGPJ	Beaumont, Tex.	1712	KSW	Berkeley, Calif.	2422	WPEG	New York, N. Y.	2450	WPDR	Rochester, N. Y.	2458
KGPL	Los Angeles, Calif.	1712	WCK	Belle Island, Mich.	2414	WPEH	Somerville, Mass.	1712	WPDT	Kokomo, Ind.	2470
KGPM	San Jose, Calif.	2470	WPDA	Tulare, Calif.	2414	WPEK	New Orleans, La.	2422	WPDU	Pittsburgh, Pa.	1712
KGPN	Davenport, Iowa	2470	WPDB	Chicago, Ill.	1712	WPEL	Arlington, Mass.	1712	WPDV	Charlotte, N. C.	2458
KGPO	Tulsa, Okla.	2450	WPDC	Chicago, Ill.	1712	WPEF	Muskegon, Mich.	2442	WPDZ	Fort Wayne, Ind.	2470
KGPP	Portland, Ore.	2442	WPDD	Chicago, Ill.	1712	WPEG	Highland Park, Ill.	2430	WRDH	Cleveland, Ohio	2458
KGPs	Bakersfield, Calif.	2414	WPDE	Louisville, Ky.	2442	WPEH	Toms River, N. J.	2430	WRDR	Grosse Pointe Village, Mich.	2414
KGPW	Salt Lake City, Utah	2470	WPDF	Flint, Mich.	2442	WPEI	Baltimore, Md.	2414	WRDQ	Toledo, Ohio	2470

THE DX LISTENER'S FORUM

This department is devoted exclusively to the DX radio listener on the broadcast band. In this department are letters from those listeners who achieve unusual results in long-distant reception. We invite all readers of this magazine to forward their list to us for publication. Only the best lists will be published.

OH BOY! WHAT RECEPTION!

Editor, RADIO-CRAFT:

I would like to take the opportunity to compare my DX record with others you publish. This record is honest and on my word of honor I have heard every station on this list which I am enclosing. These stations were heard in the space of one year and I know of some people who never get some of these stations in five years. My best pickup in daylight was KFBI, Milford, Kansas, at seven o'clock in the morning, and WKBC a 100 watter at Birmingham, Ala., at about 6:30 A. M.

If you will notice there are quite a few 100- and 250-watt stations in this list and a few of them are out of this country. The idea must not be assumed that these stations can be pulled in at any old time because I have lost many hours of good sleep staying up to three o'clock in the morning. I find the best time to listen for DX programs is on Saturday night and Sunday morning. Early west-coast stations come in very good at that time. KFI comes in regularly every night providing the weather is good.

As this set is only a seven tuber, I am very proud of this record. What do you think of it?

List of Stations

CKOK, Windsor, Ont.; WGR, Buffalo, N. Y.; WKRC, Cincinnati, Ohio; WFI, Philadelphia, Pa.; WLIT, Philadelphia, Pa.; WQAM, Miami, Fla.; WEAO, Columbus, Ohio; WMCA, New York, N. Y.; WIBW, Topeka, Kans.; WOBU, Charleston, W. Va.; WSAZ, Huntington, W. Va.; WTAG, Worcester, Mass.; WEEL, Boston, Mass.; WOW, Omaha, Neb.; WCAO, Baltimore, Md.; WMT, Waterloo, Iowa; WDAF, Kansas City, Mo.; WIP, Philadelphia, Pa.; WFLA, Clearwater, Fla.; WTMJ, Milwaukee, Wis.; CKOC, Hamilton, Ont.; CMJC, Havana, Cuba; WGBF, Evansville, Ind.; WMAL, Washington, D. C.; KFI, Los Angeles, Calif.; WAIU, Columbus, Ohio; WSM, Nashville, Tenn.; WEAF, New York, N. Y.; WMAQ, Chicago, Ill.; KPO, San Francisco, Calif.; WPTF, Raleigh, N. C.; CFRB, Toronto, Ont.; HIX, San Domingo, Haiti; WLW, Cincinnati, Ohio; WOR, Newark, N. J.; XEN, Mexico City, Mexico; WGN, Chicago, Ill.; CHYC, Montreal, Que.; CKAC, Montreal, Que.; CMK, Havana, Cuba; XER, Villa Acuna, Mexico; WSB, Atlanta, Ga.; WJR, Detroit, Mich.; WJZ, New York, N. Y.; WBBM, Chicago, Ill.; WMC, Memphis, Tenn.; WTAR, Norfolk, Va.; WGY, Schenectady, N. Y.; WBAP, Fort Worth, Texas; WFAA, Dallas, Texas; WCCO, Minneapolis, Minn.

WHAS, Louisville, Ky.; KOA, Denver, Colo.; WEEU, Reading, Pa.; WHDH, Boston, Mass.; WRUF, Gainesville, Fla.; CKGW, Toronto, Ont.; KWKH, Shreveport, La.; WWL, New Orleans, La.; WABC, New York, N. Y.; WENR, Chicago, Ill.; WLS, Chicago, Ill.; WCOC, Meridian, Miss.; WGBI, Scranton, Pa.; WSUI, Iowa City, Iowa; CMX, Havana, Cuba; KFNF, Shenandoah, Iowa; WGST, Atlanta, Ga.; WJAR, Providence, R. I.; WBEN, Buffalo, N. Y.; WJAX, Jacksonville, Fla.; WKY, Oklahoma City, Okla.; XEW, Mexico City, Mexico; HHK, Port Au Prince, Haiti; KPRC, Houston, Texas; WWJ, Detroit, Mich.; CMCD, Havana, Cuba; WBRC, Birmingham, Ala.; WDBJ, Roanoke, Va.; WCSH, Portland, Me.; WFIW, Hopkinsville, Ky.; WRC, Washington, D. C.; KMBC, Kansas City, Mo.; CKNC, Toronto, Ont.; XED, Reynosa, Mexico; WCFI, Chicago, Ill.; KDKA, Pittsburgh, Pa.; WBZ, Boston, Mass.; WHO, Des Moines, Iowa;

WOC, Davenport, Iowa; WORK, York, Pa.; WHN, New York, N. Y.; WRNY, New York, N. Y.; KYW, Chicago, Ill.; WRAX, Philadelphia, Pa.; CFCE, Montreal, Que.; KRLD, Dallas, Texas; KTHS, Hot Springs, Ark.; KFBI, Milford, Kans.; KNX, Hollywood, Calif.; WBAL, Baltimore, Md.; WJAG, Norfolk, Neb.

WTIC, Hartford, Conn.; WTAM, Cleveland, Ohio; WBT, Charlotte, N. C.; KMOX, St. Louis, Mo.; WLWL, New York, N. Y.; WPG, Atlantic City, N. J.; WRVA, Richmond, Va.; CFCA, Toronto, Ont.; WDBO, Orlando, Fla.; WDEL, Wilmington, Del.; WISN, Milwaukee, Wis.; KSL, Salt Lake City, Utah; WJJD, Mooseheart, Ill.; KVOO, Tulsa, Okla.; WAPI, Birmingham, Ala.; WHAM, Rochester, N. Y.; WOWO, Ft. Wayne, Ind.; WWVA, Wheeling, W. Va.; WCAU, Philadelphia, Pa.; KOB, State College, N. Mex.; WINS, New York, N. Y.; WOAI, San Antonio, Texas; WCOD, Harrisburg, Pa.; WFAM, La Porte, Ind.; WLAP, Louisville, Ky.;

WMBD, Peoria Heights, Ill.; WOKO, Albany, N. Y.; WSAW, Allentown, Pa.; KTBS, Shreveport, La.; WGAR, Cleveland, Ohio; WHOM, Jersey City, N. J.; KSTP, St. Paul, Minn.; WJSV, Alexandria, Va.; WLAC, Nashville, Tenn.; KFJF, Oklahoma City, Okla.; WKBW, Buffalo, N. Y.; WCKY, Covington, Ky.

WPEN, Philadelphia, Pa.; WWRL, Woodside, N. Y.; WWSW, Pittsburgh, Pa.; W2XR, Long Island City, N. Y.; W3XX, Wheaton, Md.; WEY, Boston, Mass.; WRDS, Ingham, Mich.; WTOG, Savannah, Ga.; KFBB, Great Falls, Mont.

All these stations were received with a "Zenette" seven tube super with band pass filter and four gang condenser; table model.

W. M. EASTWOOD,
Baltimore, Md.

"THE FOOL OF LONG ISLAND"

Editor, RADIO-CRAFT:

Breathes there a man
With soul so dead

Who never to his radio hath said
"Step out, baby, and pull 'em in."

With apologies to Robert Burns (Great Scott!—Ed.)—I must confess I'm not that soul-less individual for I am a firm believer that distance lends enchantment. And believe you me, I've been puh-lently enchanted twirling the dials of my "magic carpet" and soaring over the hertzian waves to here, there and mostly everywhere. I say mostly everywhere because my DXing activities are confined solely to the broadcast bands between 1,500 and 540 kilocycles; since I frown on short-wave DXing as being too easy. I employ an 8 tube screen-grid super (G. E.) with which in my air travels I have visited the forty-eight states (many times); all the Canadian provinces; several Mexican states; Bermuda, Cuba, the Bahama Islands, the Land of the Rising Sun, Australia, Alaska, Central and South America. Appearing in my log are these varied calls from many widely separated locales: JOCK, 2VA, LR4, LR3, YV1BC, KGU, RUS, XEFC, HIX, WKAQ, CMCY, CKMO, CJOR, CKWX, KGBU, VPU and HHK. Quite a galaxy you will admit.

My log totals 720 stations with 659 verified receptions and more trickling in weekly. And I shall have been DXing only 2 years this coming December. But with all my success there's one thing I can't fathom and that is: Why no Europeans? (Perhaps some Radio-Craft DXer may be able to enlighten me.)

The DXing Fool of Long Is.,

CHARLES MARTIN, JR.,

227-11 Burgoyne Ave.,

Springfield, L. I.,

New York.

(Well, men, how about telling this "fool" how to bring in the stations from across the pond.—Editor.)

BUT, FOR A CRYSTAL—

Editor, RADIO-CRAFT:

I built a crystal set using J. H. Nighswander's circuit in the December issue of RADIO CRAFT, and it does all he claimed for it, and much more. I added audio amplification and get full loud-speaker volume on many stations. I pick up many distant stations. Here are a few: KGO, 750 miles; KSL, 530; KOA, 380; WOW, 1,130; XER, 1,650; WLW, 1,730; WLS, 1,530; KNX and KFI, 930 miles; police stations KGPP, Port-

(Continued on page 693)

RADIO-CRAFT'S INFORMATION BUREAU

SPECIAL NOTICE TO CORRESPONDENTS: Ask as many questions as you like, but please observe these rules:

Furnish sufficient information, and draw a careful diagram when needed, to explain your meaning; use only one side of the paper. List each question.

Those questions which are found to represent the greatest general interest will be published here, to the extent that space permits. At least five weeks must elapse between the receipt of a question

and the appearance of its answer here.

Replies, magazines, etc., cannot be sent C. O. D. Inquiries can be answered by mail only when accompanied by 25 cents (stamps) for each separate question. Other inquiries should be marked "For Publication," to avoid misunderstanding.

PHILCO B-86 "B" UNIT

(191) Mr. Alfred Peters, Ione, Wash.

(Q.) I would like to know the wiring circuit of the Philco Socket Power "B" Eliminator, A.C. type B-86. What is the electrolyte used in this instrument? On the voltage taps, what is the K tap for? Where can the aluminum electrodes be obtained?

(A.) The schematic circuit of the Philco types B-86 and B-82 Socket power "B" Eliminators is shown in Fig. Q. 191. The electrolytic solution is a trade secret which the Philco Company has not as yet divulged. The components of the "B" unit may be obtained from the manufacturers. The following additional data concerning this device is available:

Prepare for use by pushing corks down into Philcotron cells. If using the Socket Power "B" alone, snap switch on or off each time radio set is turned on or off. If using Socket Power "B" with Philco Socket Power "A" or Philco Trickle Charger leave switch of "B" turned on; the switch on Socket Power "A," or Trickle charger, controls the "A," the "B," and the radio set.

The variable resistor should never be changed, when once set, as directed in the "complete instructions." Never add water to "B" Philcotron cells, nor put into operation before opening the vent hole in each cell.

The type B-86 unit is designed only for 50 to 60 cycles, 105 to 125 V., A.C. The type B-82 eliminator may be used on a supply of 25 to 60 cycles, 105 to 125 V., A.C.

Complete instructions: With the apparatus completely set up, turn on the set filaments, adjust the volume control to maximum and tune in a distant station; then, adjust the variable resistor of the "B" unit to secure best results.

If a strong hum is heard, try reversing the line plug, change the position of the "B" unit, or use the "anti-hum" terminal K—connect it to the negative "B" terminal of the eliminator. Use only a high-resistance meter when taking voltage readings. Once the Philcotrons cease to function they must be replaced in their entirety.

RADIO-CRAFT SET ANALYZER

(192) Mr. P. O. White, N. Jackson, Ohio.

(Q.1) I have sent for parts for the RADIO-

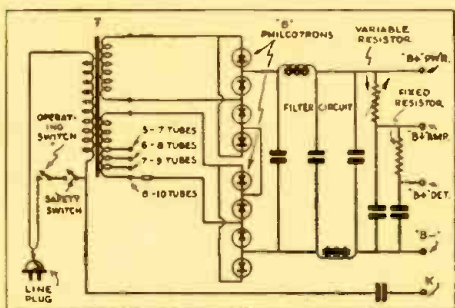

Fig. Q. 191

Schematic of Philco types B-86, B-82 eliminators.

CRAFT Set Analyzer and have it all assembled. Everything is O.K. but the A.C. scale. I have checked the readings with a Jewell Pattern 74-A A.C. voltmeter, scale 0-3/15/150 V. The 0-5 V. reading is 1 1/2 V. less; the 0-10 V., 1/2 V.; the 0-50 V., 2 1/4 V., etc. The 88,000 ohm series resistor for the 0-50 V. scale is off. Please let me have the correct value of resistors for the A.C. scale.

Incidentally, are not the S.-G. and Sup.-G. leads reversed on the schematic circuit?

(A.1) The diagram as published in the September, 1932, issue of RADIO-CRAFT is correct; there are no errors, to our knowledge.

We cannot understand the discrepancy of the 0-5 V. scale. The error in this case is 30%, and we suggest that you check over the calibration of your test meter in order

In connection with the A.C. scales of the type used in the set analyzer, it must be remembered that the resistance of the rectifier varies considerably from unit to unit, and that it is very difficult to get two rectifier units that will act exactly the same.

If you refer to the accuracies specified by the leading analyzer manufacturers, you will find that the A.C. scale is always less accurate than the D.C. scale for the reasons stated above.

(Q.2) Ollie E. Winfrey, Denver, Colo.

Will you please advise me the method used in computing the value of the A.C. multiplier resistors used in building the RADIO-CRAFT Set Analyzer, described in the September, 1932, issue?

Assuming that at the 500 V. and 1,000 V.

ranges the resistance of the rectifier is disregarded, the resistance required is 900 ohms per volt. At the 5 V. range this would require a total resistance of 4,500 ohms in the circuit. As a multiplier of 3,900 ohms is used, I subtract this from 4,500 and get 600 ohms as the resistance of the rectifier (disregarding the 50-ohm internal resistance of the voltmeter which must be considered with the rectifier anyway). Now, on the 10 V. range the total resistance should be 9,000 ohms and subtracting 600 ohms leaves 8,400 ohms as the correct resistance value—yet, the parts list calls for 8,100 ohms. The 50 V. multiplier should be 44,000 ohms instead of 88,000; but, assuming this to be in reality a 100 V. range, the resistor should be 89,400 ohms instead of 88,000 ohms. On the 250 V. range the resistor used is 220,000 ohms while to me it seems that it should be 249,000 ohms.

If the values used in the article are correct please advise me the method used to compute them as I intend building this analyzer with nine ranges of 1,000, 500, 250, 100, 50, 25, 10, 5 and 1 in A.C. V., D.C. V., and D.C. ma., using a 3-pole, 9-point switch. I think this is simpler than the combination used in the article.

(Incidentally, this is the best set tester that I have seen and I have been building them for a good many years.)

(A.2) The values of the resistors used as multipliers in this analyzer are correct. The reason for the apparent discrepancies lies in the fact that the impedance of the rectifier unit varies considerably. This variation in

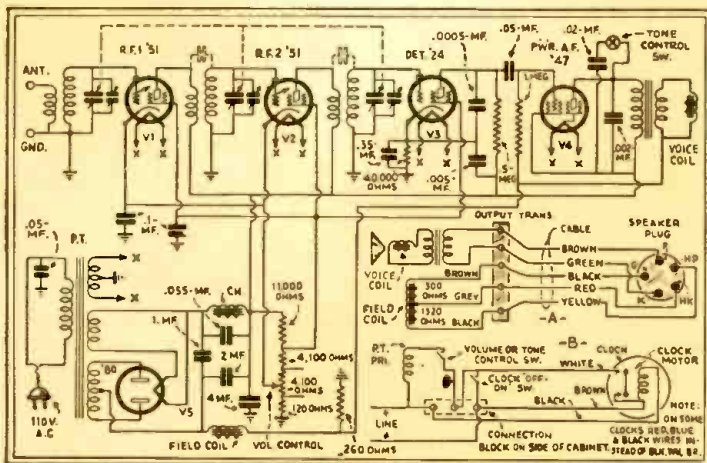

Fig. Q. 196

Schematic of the Bulova model 751 clock radio requested by Mr. Feiring.

to see whether it is indicating correctly; if it is not, then re-check the value of the multiplier resistors which are used to obtain the various ranges.

The 10 and 50 V. scales only read, according to your statement, 1/2- and 2 1/4-V. off, respectively. This represents an accuracy of 5%, which is probably within the accuracy, or tolerance, of the multipliers used, and this should not cause too much worry; more accurate calibration would require the use of resistors having closer tolerances.

The published values of resistors is correct, and our only suggestion is that you re-check them to be sure that they are within the accuracy specified.

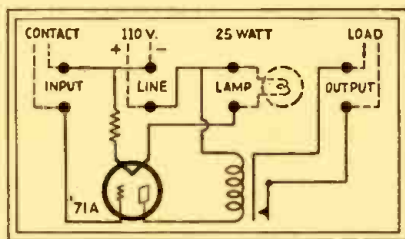

Fig. Q. 193

Schematic circuit of the Burgess Micro-Relay requested by Mr. Lintatt. This circuit, with the relay, is designed to close a circuit—or open one—carrying 6 amperes at 220 volts. Input, 1 microamp.

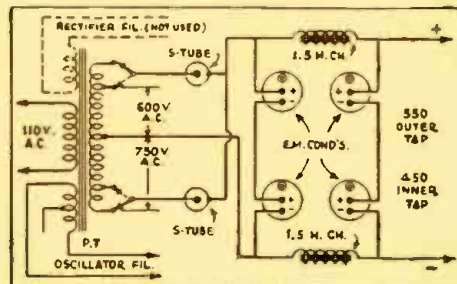

Fig. Q. 195

Circuit of the Amrad 1S1 tube. Incidentally, this tube is the first commercial filamentless tube.

the resistor must be compensated for by changes in the value of the multiplier. There is no rigid mathematical method of computing the amount of variation; that must be determined by trial. (We are glad you like the design.)

POWER TRANSFORMERS—BURGESS MICRO-RELAY

(193) Mr. R. Lintatt, Vancouver, B. C.

(Q.1) Could you give me coil data for a power transformer to be made from an old Philco "B" eliminator transformer? Also, coil data for a 10 V. bell-ringing transformer using wire and laminations from A.F. transformers.

(A.1) Complete information on the construction of power transformers has been covered in an article on the subject, which appeared in the September, 1931, issue of RADIO-CRAFT. Back issues may be obtained from the Circulation Department.

(Q.2) What is the schematic circuit of the Burgess Micro-Relay? I understand that this device is capable of closing a 1½ "electrical horse-power" circuit with an input power of only 1 "fly-power."

(A.2) The circuit of this device is shown in Fig. Q. 193. The relay is designed to open or close a circuit carrying 6 A. at 220 V. with a control-circuit current of only 1 micro-ampere (through as much as 20 megs.). This minimum current requirement eliminates the

hazard of variation or uncertainty of contact due to sparking, arcing, or oxidation of contacts in the operation of meters, industrial equipment, etc. The contact elements constitute the Burgess Vacuum Contact unit which therefore may be operated in places where explosive gases exist, etc. A time lag of 0.5-sec. eliminates chattering of the device; it may be operated on 110 V., A.C.

1932, issue of RADIO-CRAFT. The transmitter works fine and also the receiver; but, when same is passed over metal, there is no effect. The adjustment was made according to instructions; that is, the receiver was tuned to a transmitter, then the transmitter was set at an angle where no signal was heard, but, when passing the transmitter over a metal object, the signal was not brought back in. We even

went so far as to walk up to an automobile without any effect being obtained until within only a few inches from the car. The only change made in the equipment from that outlined was that we used large-size 350 mmf. tuning condensers instead of the midget, 250 mmf. units specified. This should not affect the results, as far as I can see, so long as the transmitter is working and the receiver will pick up the radiations.

Will you kindly offer suggestions and advise what is the smallest amount of metal that should affect the instrument? Do you think a quart fruit jar filled with coins would distort the electromagnetic field of the transmitter enough to register a signal in the receiver?

(A.1) Perhaps the trouble which is being experienced in connection with the RADIO-CRAFT "Treasure" Finder, which aroused such tremendous interest, is due, in part, to a slight fault which occurred in the circuit diagram of the type 33 pentode, V3; the corrected circuit, and a lengthy description of

(Continued on page 687)

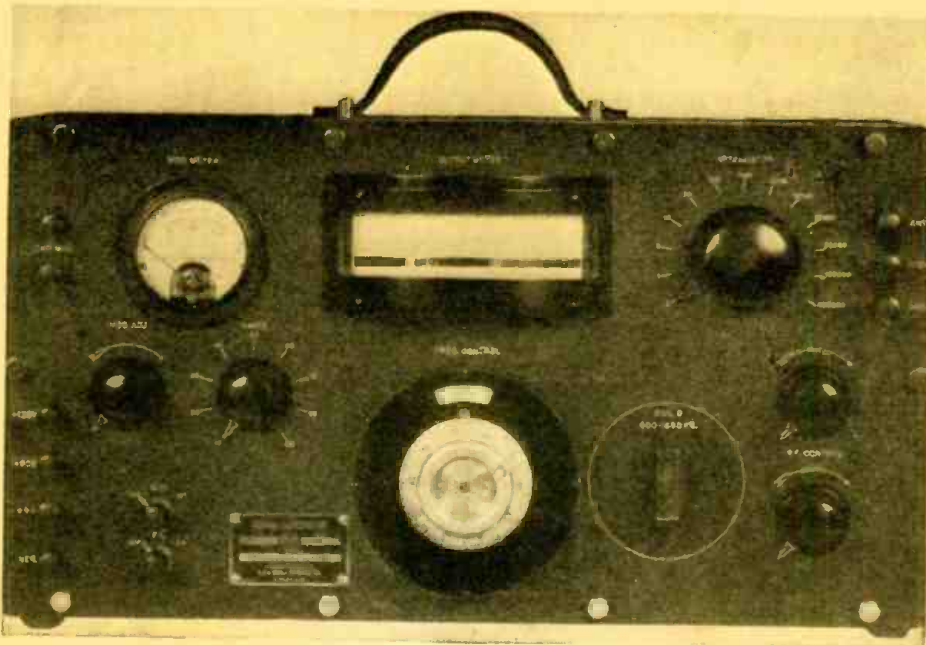

Fig. Q. 197A

Photograph of the RCA Victor A.F. modulated R.F. oscillator.

or D.C. The unmarked resistor has a value of 100 ohms.

THE RADIO "TREASURE" FINDER

(194) Mr. W. L. Patrick, Laurel, Miss.

(Q.1) I have built the Radio "Treasure" Finder as described on pg. 716 of the June,

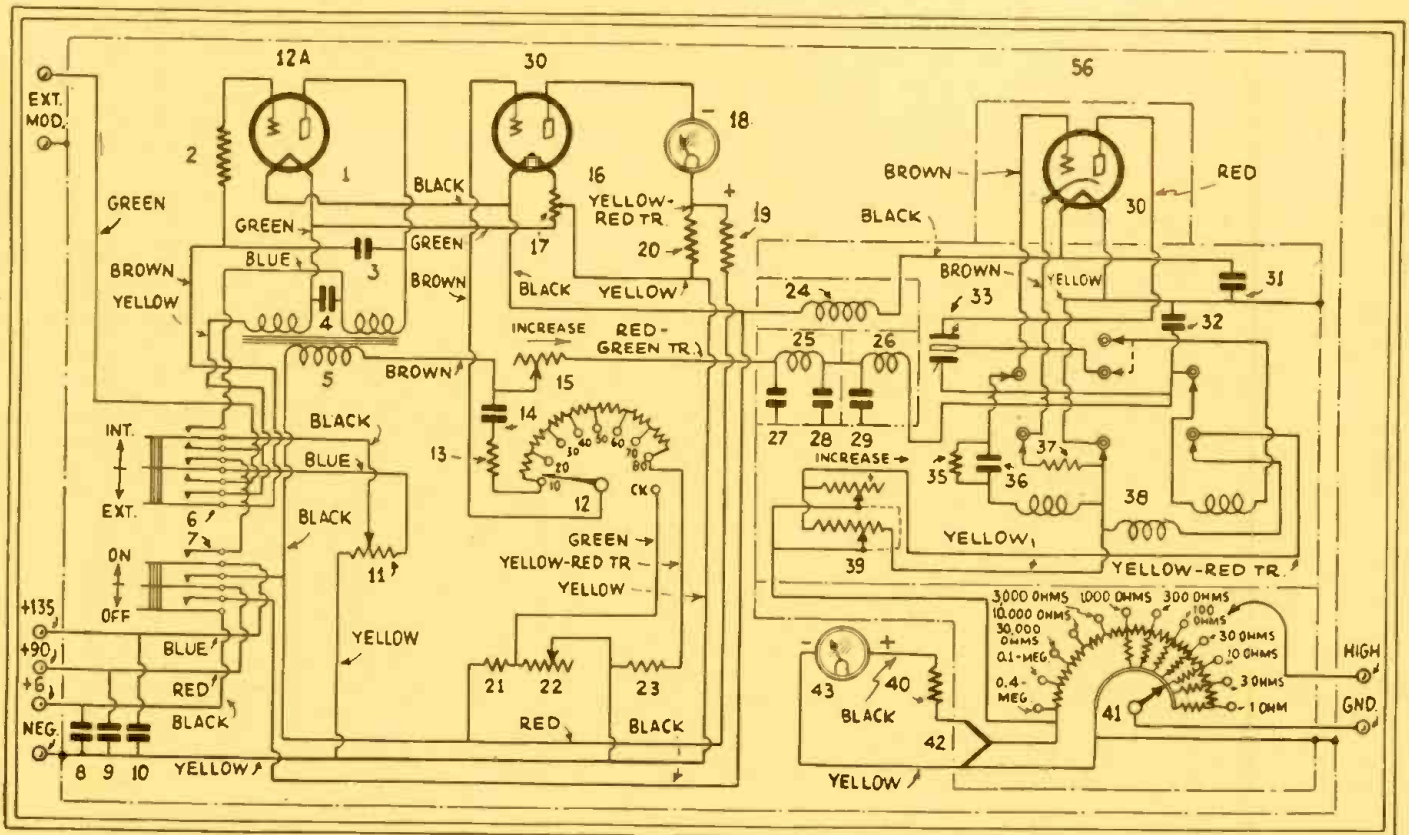

Fig. Q. 197

Complete schematic circuit of the Model TMV-18-C oscillator having a range from 90 to 10,000 kc. Use this on your midget receiver!

for MEMBERS

An Important Message to Radio Service Men

EVER SINCE the manufactured radio broadcast receiver became an accepted necessity in the household, the Radio Service Man has been an essential factor in the radio trade; and, as the complexity of electrical and mechanical design increases, a higher and higher standard of qualifications in the Service Man becomes necessary.

The need for a strong association of the technically qualified radio Service Men also becomes more pronounced as the industry progresses. This is the fundamental purpose of the OFFICIAL RADIO SERVICE MEN'S ASSOCIATION, which is not a money-making institution, or organized for profit; to unite, as a group, with common interests, all well qualified Radio Service Men; to make it readily possible for them to keep up with the demands of their profession; and above all to give them a recognized standing in their profession, and acknowledged as such by the entire radio industry.

Recently, at a meeting of the membership committee of the ASSOCIATION, a new group of members was started. Formerly, all applicants for membership were required to pass a rigid examination to prove their ability to cope with any servicing problem. However, there are a number of capable Service Men who either through lack of time or other causes cannot take the examination, and in order to permit these men to enjoy the advantages of membership, until such a time that they can pass the full membership examination, an *associate membership* was created.

In order to become an associate member, the applicant simply has to fill out a form listing his past experiences, type of test-instruments used, etc. He is then immediately accepted as an associate member and may obtain any of the essentials shown on this page. The essentials for the associate member differ only in the specification of *Associate Member* in place of *Member* as shown in the illustrations.

The Service Men's Essentials are sold only to members and associate members. Service Men are therefore urged to clip the coupon below and send it to the OFFICIAL RADIO SERVICE MEN'S ASSOCIATION, Inc.

Be sure to specify whether you desire the application for *full membership* or *associate member*.

Application for ORSMA Membership in

Executive Secretary, ORSMA
98 Park Place, New York, N. Y.

Kindly send an application blank for
 Full Membership
 Associate Membership

Name

Street or Box

City State

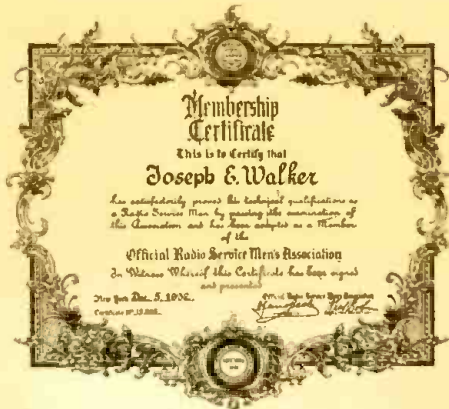

No. 14—50c each
(Plus 10c for postage)



No. 11—50c set of three cards

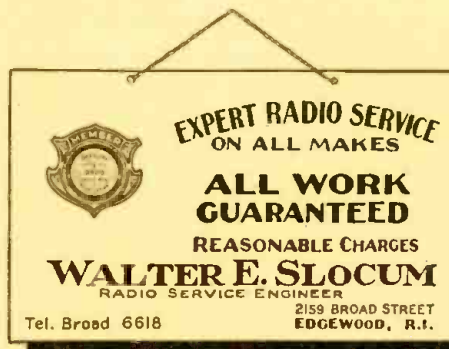

No. 12—\$3.00 set of 25 cards



RADIO SERVICE SHOP 711 Park Ave. N. W. Washington, D. C. May 1933	
Name	_____
Address	_____
Phone	_____
City	_____
State	_____
Profession	_____
Information	_____
Taken	_____
Year	_____
Label	_____
Month	_____
Per Hour	_____
Service	_____
Time	_____
Final	_____
Served by	_____
This set may operate in my entire installation, and other charges are OK.	
Signature of installation _____ <small>75 year protection, also "TOTAL" on other sets has been completely paid up.</small>	

No. 3—60c per pad of 50
\$3.00 per ten pads, each of 50

RALPH C. REEDER 1131 So. Paxson Street Philadelphia, Pa.	
SET SERVICED	TIMES CHECKED
_____	_____
SET SHOULD BE INSPECTED: _____	
WHEN IN NEED OF SERVICE MAN CALL _____	

No. 4—50c per 100
\$3.00 per 1000

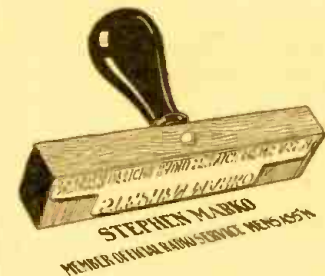

No. 8—40c each

THE RADIO SERVICE MEN'S Assortment Package	
In order to facilitate new members in getting started, we have made up an assortment of essential materials, as follows:	
100 No. 1 Letterheads	
100 No. 2 Envelopes	
1 pad (50) No. 3 Record Cards	
100 No. 4 Inspection Labels	
1 No. 5 Gold Filled ORSMA Lapel Button	
Imprinted with your name, address, city and telephone number	
Price per set	\$3.00 Prepaid

Radio Service Men's Essentials of the ORSMA



No. 9—75c each, large size
9A—60c each, small size



No. 10—75c each, large size
10A—60c each, small size



No. 5—50c each

SERVICE MEN'S ESSENTIALS

THE OFFICIAL RADIO SERVICE MEN'S ASSOCIATION has made arrangements to supply a number of "Service Men's essentials" for the use of its members and associate members. Only members and associate members can buy these items; they are not sold to others.

These essentials are priced at cost, plus a small additional fee which is the only source of income that the Association has. No one obtains any profit or benefit, except the Association itself. Whatever profit accrues, is reinvested for the furtherance and enlargement of the Association.

By using the letterheads, billheads, etc., you present the business-like appearance to your customers, so essential to successful servicing. In addition, the Association has made arrangements with most of the prominent manufacturers to allow special discounts to members, providing ORSMA letterheads are used when ordering.

No. 1 ORSMA LETTERHEADS

These letterheads, shown on the right, are furnished with your name, address and telephone number, printed on excellent paper. They are sold in lots of 100 or multiples thereof, with a distinct saving for single orders of 1,000 or more. You would have to pay many times more if you ordered small lots from your local printer. Per 100, 60c; per 1000, \$3.00.

No. 2 ORSMA ENVELOPES

These are furnished to match the letterheads, printed with your name and address, and seal of the Association. They go hand-in-hand with the letterheads and are usually ordered in the same quantity. Per 100, 60c; per 1000, \$3.00.

No. 3 ORSMA SERVICE RECORD CARDS

They serve a double purpose; whenever you complete a job you fill out the report-bill and hand it to the customer; this is the "psychological moment" to collect. By the use of carbon paper a permanent record is kept which is a valuable asset to your business. They are furnished with your name, address and telephone number. Per pad of 50, 60c; per 10 pads, each of 50, \$3.00.

No. 4 ORSMA INSPECTION LABELS

The label is to be filled in with the proper dates, and pasted inside the set or cabinet where the customer will see it. It is a continuous reminder to him that, when service is needed, he can call you again. The advantage is apparent. Per 100, 50c; per 1000, \$3.00.

No. 5 ORSMA LAPEL BUTTON

At the suggestion of many members a handsome lapel button bearing the name and emblem of the Association has been designed. It signifies to your fellow members that you belong to the same Association;—and in addition it gives your customers a better appreciation of the professional nature of your work. 50c each.

No. 6 ORSMA BUSINESS CARDS

These are furnished on a fine grade of paper in two colors with a blotter back. Thus they present an added incentive to your customers to keep them in a prominent place, where they will do the most good. They are printed with your name, address, and telephone and bear the official seal of the Association. Per 100, 75c; per 1000, \$4.00.

No. 7 ORSMA EMBOSSED STICKERS

Ideal for use in sealing packages, envelopes, etc., or for use on post cards. They give your letters or cards a professional aspect. They are sold in lots of 100 or more. Per 100, 85c; per 1000, \$6.00.

No. 8 ORSMA RUBBER STAMP

A handy addition to any member's equipment. The first line of the stamp bears your name and the second reads—Member Official Radio Service Men's Ass'n. This stamp has many uses in the everyday life of a Service Man. 40c each.

Nos. 9 & 10 ORSMA EMBLEM CUTS

These cuts for printing, advertising, etc., are furnished in two styles and sizes. They may be used for newspaper or telephone-book advertisements or for printing of any kind. Large size, 1 1/4 x 1 1/4 in., 75c each; small size, 3/4 x 3/4 in., 60c each.

No. 11 ORSMA MEMBERSHIP SIGN

A set of three of these signs, printed on heavy cards, and having holes punched in order to hang in your office or store, and are sold to members and associate members. They are large enough so that they are quite prominent and the two tone effect makes a very attractive appearance. Set of three, 50c.

No. 12 ORSMA ADVERTISING DISPLAY SIGN

A two color sign printed in large letters with your name, address and telephone, with the seal of the Association. This sign is sold in quantities of 25 or more and is ideal for hanging in stores, offices, etc., for advertising purposes. Set of 25 cards, \$3.00.

No. 13 RADIO SERVICE MEN'S ASSORTMENT PACKAGE

This includes one gold filled lapel button, 100 letterheads, 100 envelopes, 50 service record cards, and 100 labels printed with your name and address as described above. The whole assortment costs only—\$3.00—a worth-while saving. Complete, \$3.00.

No. 14 ORSMA MEMBER CERTIFICATE

A handsome diploma-like certificate engraved on stiff vellum-bond. The certificate is personally signed by the President and Executive Secretary and the corporation stamp of the Association is impressed on a red seal attached to it. Your name, certificate number and date of registration are lettered by hand and the Certificate is mailed in a cardboard tube to insure safe delivery. Each 50c, plus 10c for postage.



No. 1—60c per 100
\$3.00 per 1000



No. 2—60c per 100
\$3.00 per 1000



No. 6—80c per 100
\$4.00 per 1000



No. 7—85c per 100
\$6.00 per 1000

OFFICIAL RADIO SERVICE MEN'S ASSOCIATION

98RC Park Place, New York, N. Y.

Please send me the following RADIO SERVICE MEN'S ESSENTIALS which I have selected from this advertisement. My remittance for \$..... is enclosed. Send remittance in form of check or money order. Register letter if it contains, cash currency or unused U. S. Postage Stamps.

.....
.....
.....

Name ORSMA No. Address City and State

A SUPER-SENSITIVE ALL-WAVE CRYSTAL SET

J. M. NIGHSWANDER

A description of a crystal receiver designed for all-wave reception. This set is an out-growth of the original set described by the author in our December, 1932 issue. It is especially designed for the man entering the radio field.

A SUPER-SENSITIVE all-wave crystal set using plug-in-coils was developed by the writer and described in the December, 1932, issue of RADIO-CRAFT, page 354. Now, a new circuit has been brought out which is much more sensitive and selective than the earlier design. The latest arrangement uses but two plug-in coils (taken from an old S.-W. set), one for each wave band, and there is but one basic change in the circuit. The improved circuit design is shown in Fig. 1.

Using the set with a long antenna and a ground connection, KFI (640 kc.) was the highest possible station to be tuned in. The lower part of the broadcast band and short-wave stations are received with the new set with as much volume and far better selectivity than could be obtained with the old set by using this long outdoor antenna; instead of a ground connection, a 50 ft. indoor antenna is used as a sort of counterpoise. This counterpoise lowers the tuning limit somewhat.

(Other builders of the old circuit report distant reception of air ports and

'planes, police, and some S.-W. stations, using about a 60 ft. antenna and a 60 ft. counterpoise and tapping the coil at 3 and 9 turns from the ground end.)

What the set has done: In a few days operation this set has brought in police calls from Seattle, Portland, San Francisco, Berkeley and Denver; air ports in Oregon, Washington, Idaho, Wyoming, Utah, Arizona, Colorado and California, with many 'planes in flight. Heard: Amateur 'phone from half across the U. S. and two S.-W. broadcast stations upon adjacent channels on the night of Feb. 7. (Caught the call of but one at 8:01 P. M. [Pacific time], W3XL, 6,425 kc., 46.96 meters, Bound Brook, N. J., playing marimba solo, La Sorrella.) And as for code, some nights it's like a bee hive!

The relative broadness of tuning on this set is an advantage in finding S.W. broadcasts and other voice signals, although, as a crystal set goes, it tunes sharp.

Building the Set

The coils can be built on celluloid, bakelite, or paper forms 3 ins. in dia.

Use No. 18 or 20 S.C.C. or D.C.C. wire, spaced about 18 turns to the inch.

The large coil, L2, in Fig. 1, has 54 turns, tapped, from the ground end, at 6, 15, 27, and 40 turns. This coil goes far below the broadcast band. For the real short-wave band the coil L2 should have 15 turns, tapped at 3, 6, 9, and 12 turns from the ground end. This coil, using a counter-poise, goes up into the broadcast band and separates stations better, with good volume, than the large coil. It is not known how far this coil will tune below 46.96 meters.

Coil L1, the untuned, fixed, 11-turn primary, is made in the general manner described for coils L2; coil L1 must be made just small enough to slip inside and at the ground end of either of the coils which are used as L2. (This primary is not a very important winding and is used but little, although, if loosely coupled when using a ground, it results in increased selectivity on loud signals.)

The same station will come in on several taps, but use the one which places the station lowest on the tuning
(Continued on page 687)

THE RADIO BEGINNER

• In this department we shall print every month simple, but effective radio sets and circuits, and other information for radio beginners, or those just starting in radio. There are thousands of radio fans and experimenters who are still interested in building their own, and

in experimenting with home-made sets. The new instruments, as well as the new tubes, make this endeavor of particular importance.

If you build the sets described in these pages, won't you be good enough to advise us what results you are getting?

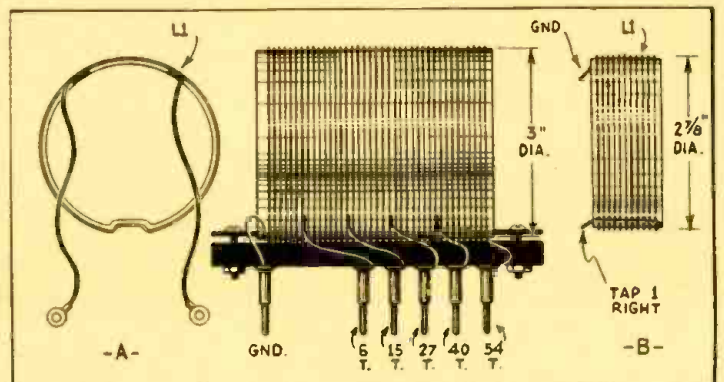
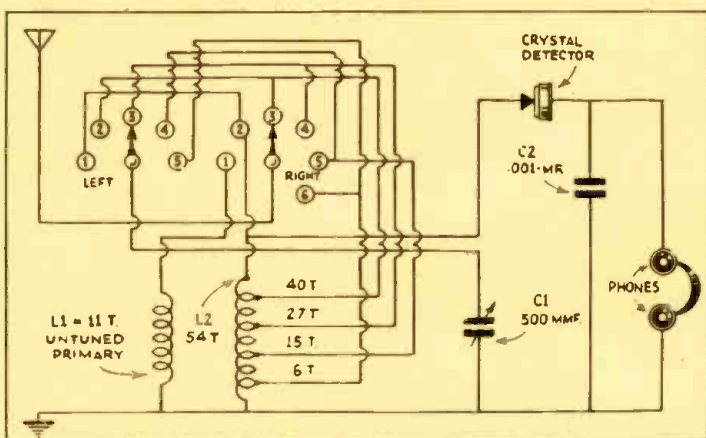

Fig. 1, left. Schematic circuit of the receiver described. Fig. 2, above. Sketch of the tuning coil. Two coils are needed to cover both the broadcast and short-wave bands.

FREE!

**AN IMPORTANT NEW
IRC SERVICE HELP**

If your name isn't on the IRC mailing list, better get it there—quick! Beginning with April the makers of the famous IRC Metallized and Power Wire Wound Resistors and Motor Radio Suppressors will issue one of the finest, most useful helps ever prepared for the radio service man—a monthly publication known as the "IRC SERVICE CALL." Far from being a mere "puff sheet" this little magazine will contain more interesting, more helpful information than you'd imagine could be packed between two covers. You'll not only read it and enjoy it BUT YOU'LL PROFIT FROM EVERY ISSUE. Drop us a line on your business stationery—today. Don't miss it!



INTERNATIONAL RESISTANCE CO.
2006 Chestnut St., Philadelphia, Pa.
In Canada, 74 Wellington St., W., Toronto, Ont.

**NATIONAL
STEWART WARNER**

Scott
**BOSCH
LINCOLN
Hammarlund
SILVER-MARSHALL**

**OWNERS
NOW**

In increasing numbers
CLAIM BETTER RECEPTION
with the NEW noise-free

LYNCH

Short Wave Antenna System

Complete Kit..... **\$5.00**

At All LYNCH Jobbers and Dealers

If your Jobber, Dealer or Serviceman cannot supply you, order direct from us. Sent post-paid, with Instruction Booklet, upon receipt of \$5.

Free Descriptive Folder upon request.

LYNCH MANUFACTURING CO., Inc.
711RP—General Motors Bldg., New York, N. Y.
Makers of the Famous Metallized Resistors

**CONCOURSE
New-Improved-Simplified**



**ELECTROLYTIC
CONDENSER**

for sub-panel one-hole mounting.

Can be used in either new radio sets or for replacements.

Eliminates threaded nipple and large hexnut. Makes a more rigid contact to chassis without the usual mechanical strain on the thin metal container.

Send in your request for our complete descriptive catalog

CONCOURSE

ELECTRIC CO. INC.
389-409 Wales Ave., N. Y. City

On page 646 of this issue will be found an important announcement of the CONSOLIDATED RADIO SERVICE MANUAL. It is worth your while to spend a few minutes reading this advertisement which tells how you can buy this book on our new purchase plan.

Quasi-Optical Home Experiments

John B. Brennan, Jr.

IT was the intention of the author in this fifth of the series explaining simple home experiments in the quasi-optical field to describe in detail the various experiments which could be conducted with the apparatus previously described in this department together with a length of quartz tubing—that glass-like material which possesses the unique property of confining within its walls a beam of light, so that no matter how the tubing is bent, the light rays will follow this winding path and be emitted at the other end.

Upon investigation, however, it was found that, relatively speaking, the sources of supply for quartz tubing were so few and the cost, in many cases, so prohibitive, that only a general explanation of this experiment should be given, merely to illustrate the peculiar properties of quartz tubing. Of course, those experimenters whose pocketbook is sufficiently large may wish to indulge in this luxury and perform the experiment.

So far, in this department, there have been described a high quality audio channel to whose output could be connected the conventional television tube, or crater lamp, and a photo-electric cell with its associate amplifier and loud speaker. The only additional piece of apparatus required for the experiment is the quartz tubing, bent into some peculiar shape, such as a U-shape, L-shape or S-shape.

Now, if the high quality audio channel has its input fed by some form of audio frequency, either from a phonograph pick-up or from a radio receiver, then there will be produced in the television neon tube, or crater lamp, minute variations of light intensity, entirely too rapid for the eye to follow.

If the quartz tubing be placed so that one of its open ends be near this neon tube while its other end be placed near the photo-electric cell, to which is attached its amplifier, then, regardless of the peculiar excursions of the shape of the quartz tubing, the light entering it at one end will, with all fidelity, be emitted at the other end and energize the photo-cell so that the light variations can be changed to electrical current variations, and so be reproduced and amplified, finally actuating the loudspeaker.

Continuing last month's discussion on the various types of mechanical and electrical light modulators with which experiments can be conducted, one more such modulator is described here.

Probably all of us are familiar with the short-lived electrostatic loud-speaker of a few years ago. The principle of its operation was based on the fact that two charged bodies of similar polarity tended to repel each other; and, if the motivating force be altered, or varied rapidly, then there would be a coincident movement in one or the other of the charged bodies.

In the electrostatic loudspeaker one of the charged bodies usually assumes the form of a ribbed rigid metal plate, while over it is stretch-

ed a piece of thin rubber sheeting. On the upper surface of this rubber sheet there is deposited a metal film which comprises the other electrode, or charged body. Now, when these two bodies are charged, we must sensibly come to the conclusion that the rubber sheet, on which is deposited in metallic form the one electrode, will give way more readily than the ribbed metal plate because of the former's greater resiliency. If the rate of charge be altered, or varied, rapidly at an audio frequency rate it is easy to understand how the rubber sheet electrode or diaphragm pushes the air in front of it to cause sound.

Now this principle, after a fashion, is also used for the modulation of a beam of light, especially in the talking movie field.

Two strips of metal, both resilient to a certain degree and insulated from each other by some protecting film or coating are placed parallel to each other and in such a position that in a state of rest, or without any energizing voltage, they are so close together as to prevent the passage of a beam of light between them from an exciter lamp. Keeping in mind the action of the electrostatic loudspeaker, it is easy to understand how the output from an audio amplifier would cause these two parallel ribbons of metal to move away from each other in a repelling action, thus allowing more or less light

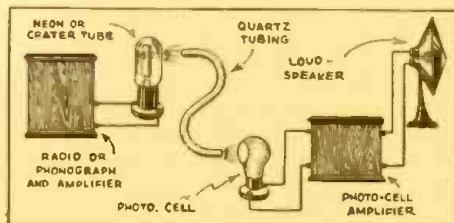

to pass through the gate thus provided, depending of course upon the variations of the energizing source.

Some experimenters may wish to feed their high quality audio channel with audio frequencies other than those obtained from a phonograph pickup or from a radio receiver. In such cases one of the simplest and most inexpensive devices is a home-made microphone, manufactured on the well-known kitchen table with the aid of one of the far famed Skindervikken buttons. So numerous are the ways in which this button can be used, and so varied are the circuits in which it can be employed that to attempt to describe even a few would be mere duplication of effort, especially when space in this department is at such a premium. For detailed information concerning its many uses the reader is referred to the descriptive pamphlet which accompanies each one of these Skindervikken buttons.

Next month . . . talking movies and their relation to light sensitive and light modulating devices.

NEW SYSTEM OF NUMBERING TUBES

Designations for new tubes are now being assigned by most manufacturers in accordance with a system recently adopted by the Radio Manufacturers Association. A new system has become necessary because practically all of the available two and three digit combinations have been utilized.

The new method, which provides for further expansion of tube types, ordinarily requires only three symbols. These are arranged with the numeral first, then a letter followed by a numeral. The first numeral indicates the filament or heater voltage by one-volt steps; thus 2 of the example "2A5" covers any voltage from 2 to 2.9 volts. The last numeral indicates the number of usable tube elements with external connections; thus the 2A5 has five such elements. The letter is an additional distinguishing symbol which is arbitrarily assigned for each new tube type.

Following are some examples of hypothetical tubes:

Description	Type Number
Five Volt Filament Type Triode (First of such a group).....	5A3

Five Volt Filament Type Triode (Second of such a group).....	5B3
Two Volt Filament Type Triode (First one).....	1A3
Two and One-Half Heater Type Triode (Second one).....	2B4
Six and Three Tenths Volt Heater Tetrode (Third one).....	6C5
Six and Three Tenths Volt Heater Type Pentode Suppressor Connection Internal (First one).....	6A5
Six and Three Tenths Volt Heater Type Pentode Suppressor Connection to Base Pin (Second one).....	6B6
Five Volt Filament Type Full Wave Rectifier (First one).....	5Z3
Two and One-Half Volt Heater Type Double Diode and Triode Combination (Second one).....	2B6

It shall be standard in a multiple grid tube to number the grids consecutively according to their location proceeding from the cathode toward the anode. The grid shall be thus designated: No. 1 grid, No. 2 grid, et cetera. Co-planer or twin grids shall be designated: No 1-A grid, No. 1-B grid, et cetera.

RADIO-CRAFT READERS' DEPARTMENT

(Continued from page 665)

placed it with a new one and the set was O.K. for about a month, when the other (smaller) condenser of this unit also gave out. After replacing the second faulty unit the set functioned perfectly.

From our experience in servicing these sets we would advise the Service Man to check very carefully all bypass condensers—particularly those in the resistance-coupled A. F. unit, because when any of these let go, the set will still work, but very weak, the tubes will overheat, and the dynamic reproducer case will get hot.

A. J. NORTHROP & SON,
East Berne, N. Y.

WORLD-WIDE RADIO TIME

In Fig. 1 is reproduced, by courtesy of QST Publishing Co., a useful chart which indicates at a glance the time which exists at various points throughout the globe, at a given moment. During the winter, reception conditions are particularly good in the 200- to 550-meter band; but, during the summer months, the shorter wavelengths become extremely effective, and, therefore, beginners in short-wave radio reception will find this reference valuable at this time. It is pointed out that distant signals above 33 meters are not received well in daylight, and distant signals below 25 meters do not come in well at night.

A SOCKET-TYPE ALIGNING TOOL

Alvin C. Porter

Most Service Men have in their tool kits a socket wrench equipped with several removable sockets for different size nuts; also, a screw driver socket. By using these sockets on the end of a $\frac{1}{8}$ -in. fiber rod, about 8 ins. long, a practically unbreakable neutralizing and aligning tool can be made; and one that will fit almost every aligning condenser. A small knob on the other end of the rod makes for easy turning, as shown in Fig. 2.

ENGINE-HOOD HOOKS FOR MOUNTING ANALYZERS

W. R. Wallick

The writer solved the problem of conveniently mounting the set analyzer (the time required to clip the analyzer in or out is 8 seconds) on the back-board of his service bench by using a Ford No. 16750-B engine-hood hook, as illustrated in Fig. 3.

QUICK WATSON, THE PEAKED CAP!

Editor, RADIO-CRAFT:

I have been a reader of your magazine for many years and have obtained a lot of helpful tips from your department known as "The Service Man's Forum."

Because we have received so many little helpful hints, we thought perhaps someone else might be benefited by the results of a case we ran across the other day.

We were called to service one of the early model Freshman sets on which the complaint was "no volume." The set, tubes, and aerial were checked and found to be in perfect order, but still the locals could just barely be heard. We were about to take the set into the shop when we noticed a peculiar thing. This set had come out with very rough composition sockets and the owner, while trying to insert the tubes in the dark, had rubbed off quite a lot of the soft solder which was on the prong ends onto the sockets. This caused a leakage across the sockets, and the consequent loss of volume. After this lead was cleaned off, the set worked normally, and another customer was satisfied.

W. C. BURY.

Lagoon Radio Service,
2805 Henn. Ave., Minneapolis, Minn.

(Our Radio Detective is with us again, and, curved pipe or not, he successfully ferrets out the leak. (Hi!)—Editor.)

(Continued on page 691)

Westinghouse RADIO INSTRUMENTS

... are used in the new Coast-To-Coast Radio Corporation Circuit Analyzer recently introduced.

The Universal AC-DC instrument used in this analyzer is one of a complete Westinghouse line which includes Ammeters, Voltmeters, Milliammeters, and Radio Frequency Ammeters and Milliammeters. They cover all the requirements for Radio Engineering, Service and Research, Television, Sound Recording, Photo-cell applications and for Public Address Systems as indicators of power level and other important characteristics.

A NEW DEVELOPMENT

A new line of Westinghouse small-size, super-sensitive instruments has just been completed. Known as types MX and NX, these instruments are available in $2\frac{1}{4}$ and $3\frac{1}{2}$ inch sizes, flush mounting. "Moldarta" molded cases of pleasing appearance. Their sensitivity is so great that for the first time a 2-inch instrument is available with 20 micro-amperes full scale deflection.

For prices and complete information, see your local Westinghouse dealer, or write to the Coast-To-Coast Radio Corp., 123 West 17th Street, New York City.

SERVICE MEN

Write for your copy of COMPLETE CIRCUIT DIAGRAMS showing how to construct and wire the above illustrated Analyzer. All constants given. Furnished gratis.



Westinghouse Electric & Mfg. Company

Room 2-N

East Pittsburgh, Pa.

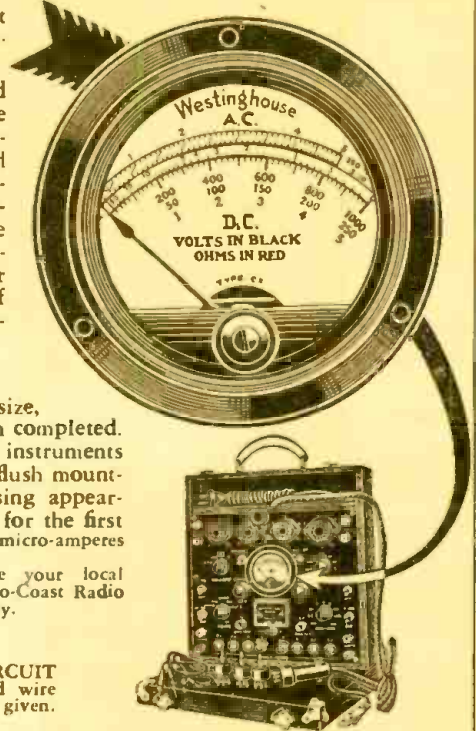

The House of COAST-TO-COAST-RADIO-CORP Presents The 1933 MODEL LABORATORY STANDARD "ALL-PURPOSE" ONE METER SET AND TUBE ANALYZER

EQUIPPED WITH A Westinghouse UNIVERSAL AC-DC METER

Available in KIT or FACTORY WIRED MODELS

Equipped with individual 4, 5, 6, 7 prong sockets which permit testing of all present and future tubes.—no adapters required! Measures with absolute accuracy all DC or AC VOLTAGES between any possible combination of any two tube elements or any one tube element and ground, reading the astounding total of 72 such tests, each one of which can be read on the following 14 voltage ranges: 0-5, 0-10, 0-50, 0-100, 0-250, 0-500, 0-1000 Volts BOTH AC and DC, at 1000 OHMS PER VOLT! There are FIVE DC and ONE AC MILLIAMMETER RANGES: 0-1, 0-5, 0-20, 0-100, and 0-250 DC, M. A. as well as 0-1.0 A.C. MILLIAMPERES.

All the foregoing voltage and milliammeter tests are intended for both INTERNAL and EXTERNAL TEST REQUIREMENTS. The 0 to 10,000 and 0 to 100,000 OHMS resistance ranges are available for both external use and for point to point resistance measurements.

Two IMPEDANCE RANGES permit measurements of choke coils, condensers, transformers, etc. Various valuable charts for output, power level measurements, grid resistors, electrolytic condensers, hum level, etc., are supplied. When the analyzer plug is inserted into any socket of any receiver, power amplifier etc. in the conventional manner, all vital tube characteristics of any type such as the new 8 terminal tubes: 6A7, 6B7, 2A7, 2B7, etc., etc., can be obtained, thus acting as a tube tester. In this manner, the most complicated receiver circuits can be completely analyzed.

The WESTINGHOUSE METER employed in this analyzer is of special design; it has a silver finished $2\frac{1}{2}$ " metal scale with 6 different calibrated ranges, engraved in black and red, and has a bakelite case ($3\frac{1}{2}$ " in diameter). Two 10 M. A. fuses offer complete protection. The interchangeable needle point test leads are equipped with patented spring band chuck-pieces which can be instantaneously shifted from one set of female receptacle jack binding posts to another. Compactly housed in a durable and attractive carrying case (with protective metal corners, rubber feet, removable cover and roomy compartment). Overall Dimensions: 13x13x5 inches. Furnished complete with all accessories and instructions enumerated in List of Parts herewith.

LIST OF PARTS

Individual parts as listed to the right, may be purchased separately, at prices quoted.

One "Westinghouse" Calibrated Universal Meter	\$ 9.00
Four "Eby" Sockets (One each 4, 5, 6, and 7 prong)	.95
Eight "C-T-C" 3-in-1 Jack Binding Posts	2.00
One "Yaxley" Single Pole Nine Position Rotary Switch	.98
Two "Yaxley" 1 Pole 7 Position Rotary Switches	.57
One "Yaxley" Four Pole Five Position Rotary Switch	1.65
Five "H. & H." P.D.T. Toggle Switches	3.00
One "Yaxley" T.P.D.T. Jack Switch	.92
Two "Yaxley" D.P.D.T. Push-Button Switches	1.47
Two "Yaxley" "On-Off" Push-Button Switches	.24
Six Flush Mount Push-Buttons	1.80
Set of 18 1/2% Super-Precision wire-wound Resistors	19.70
One Panel Board for Resistors and Fuses (Drilled)	1.25
One "Electrad" 300 ohm Wire Wound Rheostat	.60
One "Electrad" 4000 ohm Wire Wound Potentiometer	.60
One "Alden" 7 to 8 Prong Analyzer Plug With Center Pin and Grid Cap, Including 5 Feet of 9-Wire Cable	3.75
Three "Alden" Analyzer Plug Adapters	2.23
One Pair of "C-T-C" Needle Point Test Leads With Band Spring Chuck Plugs	2.50
One "C-T-C" Portable Case	4.95
One "C-T-C" Analyzer Panel, Drilled and Engraved	13.50
Set of Blueprints, Charts, Instructions, etc.	5.00
Miscellaneous cables, Wire, Hardware, Batteries, etc.	3.50
Total	\$80.15

Complete Kit Purchased at Once \$69.50

Time—Special Inducement—

Completely Factory Wired and Calibrated \$79.50

Ready for Immediate Use



COAST-TO-COAST-RADIO-CORPORATION.
123 WEST 17TH STREET
NEW YORK, N. Y.



AD-A-SWITCH is the Emergency Control!

With a skeleton stock of CLAROSTAT AD-A-SWITCH Controls over 70% of volume control replacements can be handled.

because

one control can serve either for plain or switch type the shaft is completely insulated from the contact arm—the combined length of shaft (with the mounting bushing) is 1 1/4"—sufficient to take care of most requirements—Standard Ad-A-Switch Controls are available in all tapers and electrical characteristics. AD-A-SWITCH is recognized and adopted as the only emergency. Control rendering maximum service with minimum investment.

A helpful VOLUME CONTROL and RESISTOR GUIDE is available upon request.

"AD-A-SWITCH" was originated by Clarostat

CLAROSTAT Mfg. Co.
285-287 N. 6TH ST. BKLYN. N.Y.

SERVICEMEN! DEALERS! YOUR PROFIT GUIDE FREE! EVERYTHING NEW!

Send Today
for this
BIG CATALOG

If you haven't a copy of the RADOLEK 1933 PROFIT GUIDE you are without the biggest and most complete catalog of Radio Merchandise ever compiled by a house catering exclusively to Radio Servicemen and Dealers.

**NEW MERCHANDISE AT
LOWEST WHOLESALE PRICES**

Attach this ad to your letterhead or enclose your business card and mail to

THE RADOLEK CO.
123 Canal Station. CHICAGO, ILL.

RADIO MEN:—NOW!! EVEREADY SERVICE CEMENT

Here's what you have needed, a fast drying, transparent, flexible, waterproof and vibration proof cement, for repairing speaker cones, spiders, supporting leads, coils, cementing loose tube bases, grid caps, and other uses where a dependable cement is needed. This is a Pure PYROXYLIN CEMENT, specially prepared for this purpose and requires NO THINERS. Price to Radio Men \$3.35 See Your Jobber or send 35c to:



GENERAL CEMENT MFG. CO.
ROCKFORD, ILLINOIS

World-Wide Two Tube Short Wave Receiver

12,500 Mile reception record established! Tunes from 15 to 200 Meters. Gets foreign broadcasts, police calls, airplanes, amateurs, etc. DIRECT! Complete KIT (no drilling) with clear instructions to build this remarkable 2 tube receiver. \$4.75 Dry cell or AC model. Send \$1.00. Balance C.O.D. Satisfaction Guaranteed!

Short Wave Catalog R-5 FREE
HARRISON RADIO CO. 142 Liberty St. New York City

OPERATING NOTES

(Continued from page 667)

its place. Some repairmen use melted tallow on the string but this soon wears away and another service call must be made. See Fig. 2 for details.

A rather common complaint on this model is distortion at low volume. Although this condition has been caused by an open 500,000-ohm resistor in the first R.F. secondary return (which fact will be evidenced by a lack of control-grid voltage, which, in any case, is very small because of the high resistance in the circuit), this distortion has been cleared by the insertion of suitable resistors to reduce the heater voltage of the A.V.C. tube to 1.5 volts, which, at the same time, will render the receiver more stable.

RCA Victor 50

This model has necessitated more service calls for fading than for any other condition. With all operating voltages correct, tubes perfect, and all component parts tested, this condition had persisted in spite of all efforts to locate the source. After a good deal of trial and experimentation, it was found that by reducing the heater voltage of the A.V.C. 27 tube, the fading was eliminated. As in the case of the model 21, the heater voltage was reduced to 1.5 volts by means of filament resistors.

If the high heater voltage on the A.V.C. tube caused the fading on this model (it must be remembered that fading may be caused by any number of reasons), a certain and definite test may be made to establish this fact. When the receiver has been switched off for a minute or two after operating at moderate volume on a weak station and then switched on again, a sharp increase or decrease in volume without any change in the volume control setting will mean that a reduction in the A.V.C. heater voltage must be made to eliminate, or clear up, the difficulty.

RCA Victor RAE.26

A frequent cause for low volume on the phonograph of the RCA Victor RAE-26 phonograph combination has been traced to a shorted portion of the phono input transformer primary. There are five terminals on this unit, of which only four are used. The shielded conductor connecting to terminal No. 2 is often found resting against the unused terminal No. 3, shorting a section of the primary that is not used, and resulting in the complaint of poor record output. It is but a simple matter to tape up either the terminal or the shielded cable to prevent a recurrence.

Radiola 67

Some months ago, the complaint, "no control of volume," was received on a Radiola 67, a phonograph combination employing automatic volume control. This complaint immediately brought to mind a similar condition recounted in the July, 1932, issue of RADIO-CRAFT, where an open contact of the phono-radio transfer switch was found to be the cause for an inoperative receiver. When the A.V.C. 27 tube was withdrawn, the receiver would function but without any control of volume. In this case, however, withdrawal of the A.V.C. tube made little or no difference. The contacts of the transfer switch were found in proper working order. The latter fact definitely pointed toward some defect in the A.V.C. system. Proceeding on this theory, the chassis was removed from the cabinet.

As the first step toward solving the problem, the voltage divider and associated resistors in the A.V.C. system were checked for continuity in the usual manner, by placing the continuity tester or ohmmeter across each section of the voltage divider resistors. This method, although ordinarily satisfactory, was the cause of a good deal of trouble in locating the defective unit, an open 310-ohm section of the voltage divider. One end of this section is grounded, and because the entire divider is only several thousand ohms above ground, an erroneous effect was obtained when the continuity meter was placed across the open section. Little thought was at first given to the high reading obtained across this open section for the reason that the middle section is only about twice the physical size of the end one, although more than ten times larger, electrically. Again, a careful analysis of the schematic brought the error to light. A repair was effected by replacement with a 300-ohm, 25-watt wire-wound resistor.

Zenith 240

A number of Zenith model 240 receivers have been serviced because stations were not received on the proper point on the dial. Although some were rectified by re-alignment of the oscillator trimmers, it was necessary to adjust the celluloid dial scale on most in order to obtain the proper frequency settings.

Many dealers are installing this chassis in custom-built cabinets. Where this is done, and the mounting board is not as thick as that used in the manufacturer's cabinet, the back left mounting bolt, if screwed too tightly, will pass up too far and short to the biasing resistor, causing distorted and weak reception.

Zenith 244

Recently a Zenith 244, a twin reproducer receiver, presented the problem of poor and distorted tone at low volume. This condition, in several previous cases, had been found to be due to a poor A.V.C. 57 tube. Replacement of this tube, however, was barren of results. It was only after much testing and routine work that the complaint was finally traced to an improperly centered voice coil on the larger reproducer. The aid of an offset screw driver will be found necessary to adjust the voice coil on this dynamic unit for proper clearance, as the spider is anchored by means of screws not easily accessible with the ordinary screw driver.

Stromberg Carlson 25, 26

A stubborn case of fading and very erratic operation was encountered on a Stromberg Carlson model 25, 26 receiver. The symptoms in this instance were peculiar. After some minutes of normal reception, volume would suddenly lower, control of volume would become poor, and it would become necessary to readjust the station selector about twenty to thirty kilocycles from the regular band setting; some of the more powerful broadcasters being received on two points on the dial, some twenty kilocycles apart. This setting would vary every few seconds.

Although the bi-resonator condensers are a common cause for fading and no control of volume, on this model it was highly improbable that failure of these .04-mf. units would result in the erratic two-spot tuning that was experienced. However, a quick check was made to determine this condition in the manner described by the writer in the August, 1932, issue of RADIO-CRAFT. The resistance of the R.F., I.F., and first-detector secondary circuits were measured with an ohmmeter connected respectively from the control grids of the R.F., I.F., and first detector tubes to chassis. The reading obtained from the control grid of the R.F. tube to chassis was correct, approximately 100,000 ohms; but the reading, well under 100 ohms, obtained from the first detector and I.F. control-grids to chassis designated trouble in the secondary return of these circuits.

Ordinarily, this low reading is indicative of leaky or partially shorted bi-resonator or .3-mf. bypass condensers, which would have produced the complaint of poor control of volume, more than any other condition. After these units were tested and found perfect, the 100,000-ohm carbon resistor in the same circuit, located under the volume control, and which often has been found shorted to chassis resulting in no control of volume, as well as the second 100,000-ohm resistor, was checked, despite the fact that this resistor had checked satisfactorily because it is also in the secondary return circuit of the R.F. tube.

With the aid of a low-range ohmmeter, the difficulty was finally found within the condenser gang housing shield. A close inspection will reveal a screw that passes through the third gang section shield and which has been insulated from the shield by means of some wax, or compound. This screw, see Fig. 3, which is connected to the stator of the third tuning condenser, had shifted in the wax and was shorted to the shield, obtaining the strange effect as outlined. The wire to the screw from the condenser was disconnected and the problem was solved.

This receiver employs another such screw passing through the first gang section shield and connected to the stator of the first tuning condenser. This screw cannot easily be seen because of the location of the trimmer condenser,

which is mounted directly above this screw. The same shorted condition has been encountered on several occasions.

Although the manufacturer may have intended some use for these screws, their removal from the circuit did not impair the operation of the receiver. To substantiate this fact, both screws were disconnected in a set that was operating satisfactorily and no apparent difference was noted.

Stromberg Carlson 29

The line switch on this model has been a frequent offender. As in many other receivers, the switch is incorporated in the tone control. If the owner is not, or does not, intend using the set for phonograph reproduction, a repeat service call may be eliminated by interchanging

the tone control with the volume control, as both controls are identical, each being 500,000-ohm units.

Stromberg Carlson 38, 39, 40, 38A etc.

The volume controls of these receivers are often changed because of noisy operation. In most cases, these units are really bad and must be replaced, but many instances have arisen where this noisy action has been cleared without replacement of the volume control by changing the first audio tube. If the tube in this stage is gassy and draws too much plate current, this noisy effect is produced.

Strong resonance hum on these models has been found to be caused by leakage between cathode-heater of the type 58 tubes.

BATTERY-OPERATED PERSONAL RECEIVER

(Continued from page 657)

The chassis is then turned upside down, and the parts below the deck are fastened in place. The antenna coil (1) is fastened to the inside of the right chassis wall as shown. Coil (7) is fastened to the underside; hence the fields of the two coils are at right angles and cannot interact. No shielding is necessary between them. Two of the amperite mountings, (6) and (13), are secured to the inside left chassis wall. The third amperite (21) is fastened to the underside of the deck, near socket (20).

The cartridge condenser (2) is mounted vertically, having one terminal soldered to the back lug of the antenna coil secondary and the other terminal grounded to the chassis. One terminal of the mica condenser (10) is soldered to the plate lug of socket (5); its other terminal is soldered to resistor (11). Unit 16, a mica condenser lies flat against the underside of the chassis and is soldered to the plate terminal of socket (12). Its other end is soldered to a lug which is grounded to the chassis by means of a socket fastening screw. One terminal of condenser (18) is also connected to the plate lug of socket (12), while the other terminal is soldered to the control-grid lug of socket (20).

Cartridge condenser (8) is placed near the speaker cone, being connected at one end to the yellow terminal of coil (7) and at the other end to the metal chassis. The five resistors are next soldered as near as possible to the other components with which they function. A piece of flexible braid is soldered to the blue terminal of coil (1). This wire is then tied to the chassis by means of a small eyelet, so that any pull or strain on it will not affect the connection to the coil. Of course, it must be well insulated from the chassis. The chassis is now turned right-side up and the two-gang condenser is secured to the deck at the right side. The combined volume control and switch is mounted on a right-angle bracket at the left front, as illustrated. The midget speaker is mounted at the front center by means of small right angle brackets.

Wiring the Receiver

The set is now ready for wiring. The filaments are wired in first, the negative line being grounded to the chassis. Switch (23) is wired in series with the line. Grid and screen-grid circuits are wired next, then plates, bypass condensers, etc. The flexible wire with screen-grid clip which goes to the cap of tube (5) is soldered to the stator of condenser section (3). The other flexible lead to the cap of tube (12) is brought to the deck through a hole in the chassis.

If a fiber terminal strip is used as shown in Figs. A and B, this should be put on after completing as much of the wiring as possible at sockets (5) and (12). This strip is fastened about ¼ inch from the underside of the chassis deck by means of 1-inch screws which also serve to fasten the wafer sockets (5) and (12). After the wiring has been completed, the correct amperites are inserted in the mountings and the three tubes are put in their respective sockets. The batteries are hooked-up to the set and the antenna and ground are also connected.

List of Parts

- One Cardwell dual midway, featherweight variable condenser, .00035-mf. each section, type 407-CS, 3, 9;
- One Find-All antenna coupler, 1;
- One Find-All impedance coil, 7;
- One Electrad 25,000-ohm tapered volume-control potentiometer, type R1280-P, 26 with switch 23;
- Three Aerovox .02-mf. cartridge condensers, type 270, 2, 15, 18;

- One Aerovox .1-mf. cartridge condenser, type 281, 4;
- One Aerovox .25-mf. cartridge condenser, type 281, 8;
- One Aerovox .00025-mf. mica condenser, type 1460, 10;
- One Aerovox .001-mf. mica condenser, type 1460, 16;
- One I.R.C. 30,000-ohm, 1 watt, metallized resistor, type F-1, 25;
- One I.R.C. 100,000-ohm, 1 watt metallized resistor, type F-1, 17;
- One I.R.C. .25-meg., 1 watt metallized resistor, type F-1, 19;
- One I.R.C. .5-meg., 1 watt, metallized resistor, type F-1, 14;
- One I.R.C. 1 meg., 1 watt, metallized resistor, type F-1, 11;
- Two Amperites, No. 630 with mountings, 6, 13;
- One Amperite, No. 633 with mounting, 21;

(Note: above amperites are used with 6-volt storage battery. If 2-volt air cell battery is used, substitute 4V-199 amperites for the two No. 630's and omit No. 633.)

- One Trutest 5-prong wafer-type socket, 20;
- Two Trutest 4-prong wafer-type sockets, 5, 12;
- One Trutest 5-inch midget magnetic speaker, 22;
- One .5-amp. Instrument Littelfuse, No. 1007;
- One Littelfuse Gryp Connector, No. 1039,
- One Raytheon type 34 tube, 5;
- One Raytheon type 32 tube, 12;
- One Raytheon type 33 tube, 20;
- One fiber terminal strip with six soldering lugs;
- Two screen-grid clips;
- One Blan aluminum chassis, 9½ x 4 inches x 1½ inches high, No. 14 gauge;
- Three 45-volt "B" batteries;
- Three 4½-volt "C" batteries.

Optional Equipment:

- One Crowe ornamental metal cabinet, outside dimensions 10x6½x4¼ inches deep;
 - One miniature vernier dial.
- (Under views of this receiver may be obtained by sending 5 cents to the author.)

THE "RADIOLAMP" TABLE RECEIVER

(Continued from page 650)

- One Acratest volume control with switch, 250,000 ohms, R2;
- One Aerovox resistor, 50,000 ohms, R3;
- One Acratest resistor, 2.5 megohms, R4;
- One Aerovox resistor, 1 meg., R5;
- One Aerovox resistor, 1,500 ohms, R6;
- Two Find-All aerial couplers L1, L2 and L3, L4;
- One 15 henry choke, L5;
- One type 39 tube;
- One type 36 tube;
- One type 38 tube;
- One type 1223 tube;
- One 40-watt lamp;
- One Premier loudspeaker unit;
- Three five-prong sockets;
- One four-prong socket;
- One lamp socket with bushing;
- One cord and plug;
- One celluloid dial;
- One apex, cone and fittings;
- Two Blan chassis, 5¼ by 5¼ by 1¼ ins. deep, ⅞" aluminum;
- One Blan chassis, 3½ by 3½ by 1 in. deep;
- Two Blan sides, 5¼ by 6 by ⅞ ins.;
- One Blan back 5¾ by 6 by ⅞ ins.;
- One Blan front 5¾ by 6 by ⅞ ins.;
- Two No. 10-32 threaded brass rods, 8 ins. long;
- Screws, nuts, etc.



Readrite TESTER NO. 710

A Remarkable Instrument
At a Remarkable Price

THIS new and improved tester is designed for testing any radio, whether an up-to-the-minute model or any old model. It is equipped with a practical selector switch for checking all parts of the tube circuit by connecting to the set sockets. It is so designed that selection can be quickly and accurately made for testing voltages of plate, grid, cathode, suppressor grid and screen grid. Plate current, filament volts, line and power supply volts are also measured.

Capacity and resistance charts are furnished showing use of instruments for testing condensers and for measuring resistance up to 100,000 ohms.

Both A.C. and D.C. filament voltages are accurately measured on the one meter. Contains new wiring and socket for taking care of new small 7-prong tube as well as larger 7-prong tube. It is equipped with a small diameter plug-adaptor for testing in new sockets. Try this amazing tester one day and you'll wonder how you ever got along without it.

Only \$15.00 Net to Dealers
(List \$25.00)

Your jobber can supply you. If not, order direct. We will ship the No. 710 Tester directly to you—when remittance accompanies your order at the dealer's net price, \$15.00.

READRITE
Meter Works

53 College Ave.,
Bluffton, Ohio

Readrite
Meter Works,
53 College Ave.,
Bluffton, Ohio

Gentlemen:
Please send me information about Readrite No. 710 Tester. Also catalog of other servicing instruments.

Name

Street Address

City..... State.....

Mail for Details NOW

HEADQUARTERS

for Service Men's & Dealer's
Replacements & Repairs

Power Transformers rewound at lowest cost; all types of impedance matching and line transformers for broadcast or amateur use; mike transformers all types of amplifier transformers, or any other coils wound to your specifications; or, tell us what you want and we will engineer your coils without extra charge.

We design all types of precision-wound choke, inductance, and L.F. Coils for any frequency.

LOW-EAGLE REJECT-A-STAT antenna system, eliminates man made static. Easy to install—no soldered connections. Precision impedance matching transformers used in brushed-brass containers, \$1.25 per transformer.

A 3 1/2" Condenser Mike Head for only \$16.85. This is a precision head; has a flat response curve from 30 to 7,000 cycles, and makes any \$200.00 Mike head in performance. A new simplified design makes this price possible.

Microphone and Meter retuning. Stretched diaphragm carbon mikes converted into condenser heads; send us your mike for an estimate.

If you have any problems in Radio, Amplification, Transformer Design or experiments you are doing or want done, write to us for estimates. We are equipped for all precision testing in the electronic field.

If you need parts either for radio or audio-frequency amplifiers, we carry a complete stock and can give you 24 hour service. If it is Radio, we have it. Do not write for a catalogue as we do not issue one.

For \$1.50 we will send you, postpaid, calibrated charts for the accurate design of inductances, transformers, and resistors, six charts in all. All our products are absolutely guaranteed to be as represented in every respect.

Send remittance in form of check or money order.

RADIO RESEARCH LABORATORIES
Manufacturers, Designers, Consulting and
Experimental Engineers
3019 California Ave., Ft. Wayne, Ind.
20 years in the electrical and radio field

Short Wave Specials

RESCO 3 RECEIVER

Using 1-34 Screen Grid and 2-30 tubes, constructed of quality parts throughout, aluminum chassis, a n. d. panel, Vernier dial, range 15-200 M.

Assembled, wired and tested

\$9.75 less tubes

Resco S. W. 5 Tube A. C. Receiver

using (2) 57's—
(2) 56's and (1)
280 rectifier. Aluminum chassis and panel with Vernier dial. Special

\$17.95 less tubes

SHORT WAVE BARGAINS

2 1/2 V. 8 amp. 6L trans. cased	\$1.69
Set of 4 short wave PLUG-in coils	1.79
Branded head phones PER DR.	1.35
4" Bakelite dials	.15
3" Bakelite Vernier dials	.49
Bakelite coil forms ribbed	.19
Wave Sockets 4, 5 or 6 prong	.06
Telegraph Keys	.89

All Merchandise Guaranteed

Radio Electric Service Co., Inc.

N.E. Cor. 7th & Arch Sts. Phila. Pa.

USE OHIOHM SPARK SUPPRESSOR SETS

for eliminating Ignition Interference on Automobile Radios

For 4, 6 and 8 cylinder cars. Furnished complete with condenser and necessary spark suppressors. Lasts the life of the car. Special non-shorting, and temperature and vibration resisting features. Cash in on this growing market.

THE OHIO CARBON CO.
Cleveland, Ohio

AUTOCRAT AUTO RADIO 6 TUBE

Quality—Tone—Selectivity & Power

Complete \$29.40—includes set, remote control, suppressor kit, tubes, mounting brackets, dynamic spkr., antenna. Set only \$10.78. Also 4-5-6-Tube Midsets with latest tubes at low prices. Dealers wanted. Write today.

AUTOCRAT RADIO CO.

3955 N. Hamilton Ave., Chicago, Ill.

BACK ISSUES of RADIO-CRAFT can be had at the price of 25c each. Address RADIO-CRAFT, 98 Park Place, New York City.

THE 37 "RECTIFIER"

William Rankine*

In view of the rapidly increasing popularity of the so-called "Universal" receiver, tube manufacturers have been giving consideration to the development of special types of tubes for use as rectifiers in receivers of this nature. While it is possible that satisfactory operation can be secured from these new tubes, it is also desirable from the standpoint of economy, to keep the number of different types of tubes on the market as low as possible. This is desirable for two specific reasons. First, the dealer and the serviceman is not compelled to carry too large an investment in stock and secondly, the consumer may always be assured of satisfactory service in the event of his receiver becoming faulty.

From a standpoint of the Service Man, the dealer or the radio set owner, there are four essential points to be considered in the selection of a tube for any particular function in the receiver. The first is that the type is of a standard nature and one on which renewals may easily be obtained, as a result of complete distribution. It should be not more expensive than the type which it replaces. It should, as far as possible, either reduce the number of component parts required for the circuit or at least it should not require additional parts. The fourth and possibly most important point is to determine whether or not the tube will give a satisfactory account of itself throughout its life.

Following the test made in the laboratory of RCA, on tests made with the type 37 tube, for use in rectifier circuits of this nature, we have come to the following conclusion and have, therefore, determined not to introduce another type of rectifier to accomplish this purpose. The circuit characteristics of these small receivers are now quite well known and, since it is not necessary for the rectifier tube to supply more than approximately 20 ma., it is not necessary for us to use one of the mercury vapor type rectifiers or a rectifier capable of delivering the amount of power which we can take from a type 80 high-vacuum tube.

For the purpose of our test, however, we decided to put the tube on a life test which would be much more severe than it would ever encounter in practice. The tests were conducted with a drain of 40 ma. at 135 V., D.C. between the heater and the cathode. Under these conditions, the filament voltage applied to the type 37 tube was 6.3 and the filament current .3-A. The maximum plate voltage applied was 125 and the drain approximately 40 ma.

Several types of "universal" receivers were operated with the type 37 tube as a rectifier with the following results. Where the load was 20 ma., the average D.C. output of the tube was 103 volts. The maximum voltage delivered by any of those tubes tested was 108 and the minimum was 97.5. This variation was noted in about 10% of the tubes and even with this variation it was found that there was no appreciable difference in either sensitivity or power output. Furthermore, it was found that the use of the 37 eliminated the generation of R.F. noise, which sometimes occurs when other types of rectifiers are used in these receivers, and it was therefore unnecessary to use the R.F. choke, required when the other types of tubes were used. Of course, when the 37 is used as a rectifier, the plate and grid elements are fastened together. This may be done by tying the two terminals of the tube socket together with an ordinary piece of bus.

Therefore, we are of the opinion that when design engineers recognize the fact that this tube will perform all of the necessary functions for the "universal" or "A.C.D.C." type of receiver, it will rapidly come to replace those special tubes which have been developed to take care of this job.

*Engineering Dept., Triad Mfg. Co.

A. C. OHMS LAW?

Many set constructors and Service Men do not seem to realize that Ohm's Law applies to A.C. filament circuits as well as to other portions of the radio circuit. They use thin wire for the heaters—usually about No. 18—and then wonder why the tubes at the end of the line show low filament voltage.

Tubes of the 2.5-volt series draw an average of 1.75 amperes each. Eight such tubes will thus take a total of 14 amperes, which is a lot of current, anyplace. No. 14 flexible wire should be used, or two strands of No. 18 in parallel will do.

This Handy MAGAZINE Binder for all copies of RADIO-CRAFT



RADIO CRAFT

is not a magazine which is read hastily and then discarded. Readers keep their copies for years—use them repeatedly for reference, for "dope" on new tubes, for service hints and short cuts, for kinks, etc.

Now the publishers make it possible for you to save every copy and for this purpose a special binder has been designed to preserve twelve issues. This handy binder is made of a heavy, substantial material and is covered with black grain leatherette. The name RADIO-CRAFT is handsomely stamped in gold on the cover.

An ingenious mechanical arrangement is provided which makes it possible to hold copies flat when reading from the binder.

The RADIO-CRAFT binder is shipped anywhere in **\$1.25** U. S. prepaid for only \$1.25. Canada and foreign 25c extra. Use the coupon below to order.

—Mail This Coupon Today—

RADIO-CRAFT Magazine
96-98 Park Place, New York, N. Y.
Enclosed you will find my remittance for \$1.25 (Check, stamps or money order accepted) for which you are to send me, postage prepaid, the RADIO-CRAFT BINDER, large enough to hold twelve issues. (Canada and foreign add 25c extra.)

Name _____
Address _____
City _____ State _____

INFORMATION BUREAU

(Continued from page 677)

other possible causes of mal-performance, are contained in the October, 1932, issue, pg. 229. As the corrected circuit indicates, the screen-grid of V3 should have been connected to the battery side of the output load (headphones), instead of the plate side.

(Q.2) F. M. Moran, Bessemer, Ala.

On Pg. 716 of the June, 1932, issue of RADIO-CRAFT you gave a description of how to build a radio "treasure" finder. I have completed one as described in the magazine and have tried it out. It works O.K. on a buried six-inch waterpipe, but I have not had any luck on anything smaller on account of ground capacity.

I have buried a cast iron water kettle but I cannot detect the difference in sound by ear. There are body and ground capacity effects which prevent my getting the desired result. I have worn rubber hipboots and this cuts down some of the capacity effect. I am thinking of using a galvanometer in connection with the ear phones.

There is a machine that they claim will locate gold and silver. I was talking to a man the other day and he said that he could locate a bulk as small as 13 silver dollars. He saw the machine that I built and said that if I could get rid of the sound only when I came in contact with metal, it would work O.K.

Please tell me how I can make the machine silent only when I come in contact with metal.

(A.2) Note the reply, above, to Mr. W. L. Patrick.

We cannot see any logic in wanting a machine that would operate only when "contact" had been made to metals. If you could come that close, what would be the use of a "locator"?

Taking the view that what you want is a more sensitive arrangement, we suggest that you add one more tube to the output circuit of the receiver, and connect in the output circuit of this added tube a sensitive "output meter." These meters are now obtainable for use in servicing radio receivers, where an accurate, sensitive instrument is desired to indicate the exact point in the adjustment of a circuit when maximum (or minimum) reading is obtained. You may keep your headphones in the output circuit of the preceding tube, as usual, in order to "monitor" the operation of the "treasure" finder.

We wish to point out that continued use of the finder will enable you to improve your technique and thus more readily secure good results.

AMRAD "S" TUBE

(195) Mr. Charles Parker, Buffalo, N. Y.

(Q.) What are the characteristics of the old Amrad "S" tube, and how is it used?

(A.) The Amrad "S" tube was one of the first filamentless or gaseous rectifiers, and is classed with the better-known "Raytheon" group of tubes.

The model 3000 S tube is a 20 watt, half-wave rectifier tube designed to deliver 50 ma. at 300 to 750 V.; approximate life, 3,000 hours. The S tube fits a standard screw base. Operating normally, the S tube is just too hot to touch; however, when the tube becomes overheated due to overload, the interior of the glass stem becomes conducting in both directions. The primary of the power transformer must be protected by 3 A. fuses.

A schematic circuit incorporating two S tubes in a full-wave connection is shown in Fig. Q195

BULOVA CLOCK-RADIO

(196) Mr. Ernest A. Feiring, Akron, Ohio.

(Q.) In the April, 1932, issue of RADIO-CRAFT, on pg. 656, appeared an illustration of the Bulova clock-radio set. Has the schematic circuit of this receiver ever appeared in RADIO-CRAFT? How does the clock operate to control the radio set?

(A.) The schematic circuit of this instrument, the Bulova model 751 clock-radio set, is shown for the first time in RADIO-CRAFT in Fig. Q196. This circuit tells the story.

(Continued on following column)

THE WHOLE WORLD SPEAKS— Thru

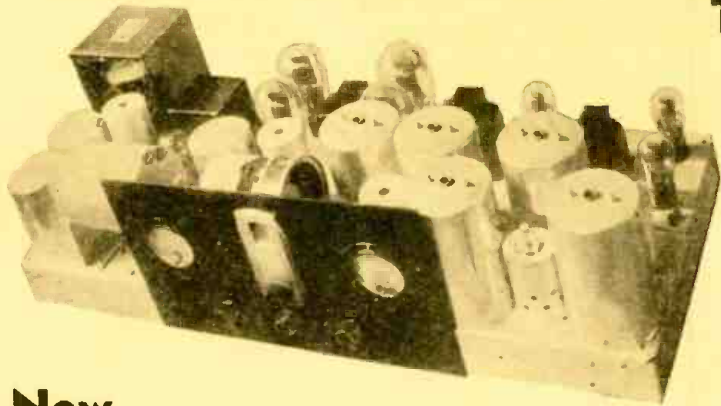

The New ADMIRALTY SUPER-15

MULTI-WAVELENGTH SUPERHETERODYNE

In design and engineering, the world's most advanced Radio Receiver. This great new 16-Tube Model opens up a vast new stage of magnificent entertainment. Dependable long distance reception with the lure of overseas programs via short waves, as well as your favorite broadcasts as they originate at the station. This is the true Romance of Radio that awaits you. The Admiralty Super-15 provides the maximum in sensitivity, selectivity and quality of reproduction ever promised.

Complete literature sent on request. Address

NORDEN-HAUCK ELECTRIC & MFG. CO.

402 Cherry Street, Philadelphia, Pa. U. S. A.

"Builders of the Highest Class Radio Apparatus in the World."

RCA VICTOR A.F. MODULATED R.F. OSCILLATOR

(197) Mr. Paul Connelly, Duboise, Ia.

(Q.) What is the schematic circuit used in the R.C.A. Victor "Standard Signal Generator"?

(A.) In Fig. Q197 is illustrated the circuit of a signal generator design. The connections are those of the R.C.A. Victor type TMV-18-C Standard Signal Generator. By means of six plug-in coils the R. F. range extends from 90 to 10,000 kc. The A.F. modulation is 80% at the fixed frequency of 400 cycles. The output voltage range extends from ¼-microvolt to 2 volts. The output impedance of the attenuator, except for the higher multiplier values, is 0.7-ohm. External modulation may be conveniently used. Thermocouple 42 is of high-resistance type and provides a means of accurately measuring the voltage input to the attenuator even at the extreme high frequencies. All available data appears in Fig. Q197. A front-view illustration of the instrument is Fig. Q197A.

A SUPER SENSITIVE ALL-WAVE CRYSTAL RECEIVER

(Continued from page 680)

condenser setting for loudest signals.

To tune to the higher frequencies, move the right-hand switch (marked "right" in Fig. 1) forward, clockwise, one to three taps before advancing the left-hand switch arm. The efficiency of this set seems to lie partly in the low-loss coils, but mostly in the one basic change in the circuit, in which the detector is connected permanently to the last turn (from ground) on the tapped coil.

List of Parts

One Puretone or Rotorit crystal detector (or a good piece of galena);
One tuning condenser, 500 mmf., C1;
One fixed condenser, .001-mf., C2;
One set of coils (see text) L1, L2;
One pair of headphones (Baldwin, Brandes, etc.);
Two tap switches, "left," "right";
Eleven taps;
One baseboard, 7 x 12 x ½-in.;
One panel, 7 x 7 x ¼-in.;
Hookup wire, screws, etc.



the new 50c Centralab Volume Control Guide

Thousands of these new Guides are now doing signal service . . . in helping servicemen to do a more efficient and satisfactory replacement job . . . with, of course, added profits.

Send for the Centralab Guide on your stationery Address Dept. C.

Centralab
CENTRAL RADIO LABORATORIES
930 E. Keefe Ave. Milwaukee, Wis.

SERVICEMEN

HERE ARE YOUR LATEST NEEDS

GET THIS ADAPTER TO MODERNIZE YOUR TUBE CHECKER

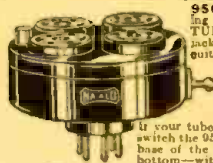

950XVL Universal Tube Checker Adapter tests over 80 NEW TUBES. No wires—no leads—no leads—very simple to operate—clear diagram and directions chart listing over 80 NEW TUBES with spaces for recording readings of these and future tubes are supplied with all orders. List Price \$6.00
If your tube checker has no filament-voltage switch the 9548GL adapter must be used on the base of the 950XVL. 9548GL UY top—UX bottom—with C. G. lead. List Price . . . \$1.25

EQUIP YOUR ANALYZER WITH THIS PLUG AND BRING IT UP TO DATE. DIAGRAMS AND DIRECTIONS SENT FREE WITH ALL ORDERS.

907WLC Famous Na-Aid Latch Lock Analyzer Plug with Twin C. G. Handle and five feet of eight-wire cable attached. List Price . . . \$5.50
907WLC (as described) List Price . . . 3.50
The 907WLC basic plug fits all seven-prong tube socket. For UX 4-hole sockets, the 974DS adapter is snapped onto the plug; for EY 4-hole sockets, the 975DS is used; for 6-contact sockets, the 976DS and for the new small size 7-contact socket as used for the 2A7, 2B7, etc., tubes, the 977DS adapter is required. All of the above four: 974DS, 975DS, 976DS and 977DS Associate Adapters. List Price . . . \$1.25 each



REPLACE YOUR OBSOLETE SOCKETS WITH THESE LATEST COMPOSITE SOCKETS

456E replaces sockets requiring a 1 3/8" panel hole and 1 1/16" mounting hole spacing—receives 4, 5 and 6 prong tubes—filament circuit common—all others isolated—has nine contacts. List Price \$.60

457E matches above but receives both 47 5-pin pentode and the 59 7-pin pentode. Cathode of 59 isolated from screen of 47. Has eight contacts 457E Composite 5-7 socket. List Price . . . \$.60

477E matches above but receives both the 59 type 7-pin tube and the new small size 7-pin tubes like the 2A7, 2B7, 6A7 and 6B7. Has seven contacts. List Price \$.60

The following sockets correspond to the above but have a 1-19/32" mounting hole spacing for a 1 3/16" panel hole.

456 4-5-6 hole socket. List Price . . . \$.50
457 5-7 hole socket. List Price \$.50
477 4-7 hole socket. List Price \$.50
437 7 hole socket. List Price \$.35
436 6 hole socket. List Price \$.25
437 7 hole socket. List Price \$.25

425 5 hole socket. List Price \$.25
424 4 hole socket. List Price \$.25

TREAT YOUR OUTPUT METER TO THIS ADAPTER



This 9PL Output Meter Adapter contacts the plate prongs of 4, 5, 6 and 7 prong tubes whether having a small or regular base—insulated for use in the new close fitting shielded sockets and equipped with a serviceable 5 foot lead. May also be used for connecting pickups, microphones, phono, extra speakers, tone controls, voltmeters, etc. 9PL List Price . . . \$.50

HERE'S THE QUICKEST, LOWEST COST METHOD OF MODERNIZING YOUR ANALYZER



965DW Enables any analyzer which can test 24 circuits to test all the new 6 prong tube circuits. 965DW List Price . . . \$2.50
965DW Same with locking stud. List Price \$2.50

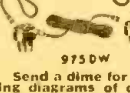

975DW Enables any analyzer which can test 24 circuits to test the 7 prong tube circuits. 975DW List Price . . . \$3.00
975DW Same with locking stud. List Price \$3.00

Send for free catalog sheets showing all kinds of sockets, plugs, connectors, coil forms, etc.

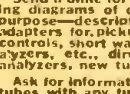

Send a dime for the Na-Aid Adapter Data sheets showing diagrams of over 300 different adapters for every purpose—descriptions, uses and directions are given on adapters for pickups, microphones, output meters, tone controls, short wave converters, tube checkers, set analyzers, etc., directions for modernizing obsolete set analyzers, new tube-prong connections, etc.

Ask for information on how to test the 25 and 30 volt tubes with any tube checker.

Servicemen's Discount 35%
On orders amounting to \$10.00 List 40%



ALDEN PRODUCTS CO.
Dept. R-5 715 Center St.
BROCKTON, MASS.

Sensitivity SHURE Tone Quality

MICROPHONES

TRADE MARK REGISTERED

SHURE BROTHERS COMPANY

Manufacturers—Engineers
S. N. SHURE, Pres.
337 WEST MADISON ST. CHICAGO, ILLINOIS

BINARY LOGARITHMS

(Base 2—Octaves)

Pamphlet of 24 mimeographed sheets. Bilogs of 1024 integers with data for all numbers. Simplest system for comparing periodicities—sound, electromagnetic, etc. Reduces array of integral ratios to greatest possible simplicity. TWO DOLLARS.

G. H. POHLAND, 1149 Felton Court, CHICAGO

There has been a rumor circulated by our competitors that we were out of business. Like Mark Twain's death, it has been grossly exaggerated. We simply moved to larger quarters and are still catering to Radio Experimenters. We do not issue a catalog but have the largest selection of old and new radio parts in the world.

BLAN THE RADIO MAN, Inc.
177 Greenwich St., New York, N. Y.

THE MICRO-MIDGET SET ANALYZER

(Continued from page 663)

No adapters are required with this analyzer, except the analyzer plug adapters which are of the 6-4, 6-5, and the 6-7 type. The analyzer plug is a six-prong plug. Only two sockets are used to take care of all tubes; one socket is a 4-, 5-, 6-hole composite socket, and the other one is a 7-prong tube socket.

All parts are mounted on a panel measuring 7x7 3/4 in. I used an old Music Master panel; this panel incidentally cost me 20 cents, thus saving myself about 78 cents were I to buy a new one.

The photograph of Fig. B shows the position of the various parts that go into the construction of the analyzer. The meter is mounted near the center of the panel (see Fig. A, also); Sw.1 to the left of the meter; Sw.2 to the right of the meter; the battery adjuster rheostat, R7, and the A.C.-D.C. switch, Sw.4, are placed above the meter. The seven-prong socket is placed to the right of the A.C.-D.C. switch. The 4-, 5-, 6-hole composite socket is placed to the left of R7. The 1,000-ohm resistor, R5, and the 4,000-ohm resistor, R6, are placed on top of the meter, while beneath the two resistors is placed the small rectifier. Directly below the meter are shown the four push button switches; the reversing switch is in the center, as are also the four resistors, R1, R2, R3 and R4. The four binding posts are mounted on the sides of the panel above the meter. The 4.5 volt "C" battery is placed in a separate box.

The position of the switch when making tests is shown on the chart in Fig. 4. When using the chart, the following should be observed:

- (1) The left column refers to the type of tube under test;
- (2) All letters in the other columns refer to the position to which the switch Sw.1 must be rotated in order to obtain the reading indicated at the top of the column;
- (3) Grid No. 1 is the input or control grid;
- (4) Grid No. 2 is the screen grid;
- (5) Grid No. 3 is the suppressor grid.

List of Parts

- One Tau-Rex copper-oxide rectifier;
- One Jewell model 88 or Weston model 301, 0-1 ma. milliammeter;
- One special switch, as described, Sw.1;
- One Eby double-pole, three-position switch, Sw.2;
- One Yaxley double-pole, double-throw switch, Sw.3;
- One Yaxley triple-pole, double-throw switch, Sw.4;
- Four Yaxley single-pole, single-throw push-button switches, Sw.5, Sw.6, Sw.7, Sw.8;
- One Precision 10,000-ohm resistor, type A, R1;
- One Precision 100,000-ohm resistor, type A, R2;
- One Precision 500,000-ohm resistor, type A, R3;
- One Van 1. meg. resistor, R4;
- One Aeratest 1,000-ohm resistor, wire wound, R5;
- One Aeratest 4,000-ohm resistor, wire wound, R6;
- One Clarostat 5,000-ohm rheostat, R7;
- One General Electric 7-wire cable;
- One Federated 6-prong analyzer plug;
- One Eby 7-hole socket; V1;
- One Na-Ald 4-, 5-, and 6-hole composite socket, V2;
- One bakelite panel, 7x7 3/4 in.;
- Four non-removable binding posts, B1, B2, B3, B4.
- One 4.5-volt "C" battery;
- One pair of test leads;
- One Eby 6-to-4 analyzer plug adapter;
- One Eby 6-to-5 analyzer plug adapter;
- One Na-Ald 6-to-7 analyzer plug adapter;

'AVEN'T YOU?

One of the saddest letters ever received by the B. B. C.: "I've a license since four years and 'ave not heard nothing." (Wireless Weekly)

NOW READY

The RADIO-CRAFT INDEX

It contains a thorough, alphabetical and topical arrangement of EVERY article and subject which has been published in all the issues of RADIO-CRAFT from July, 1929 to June, 1932

Radio Men have conclusively proved to us the need and practicability for a book which has included in it, a comprehensive and complete listing of every article which has thus far been published in RADIO-CRAFT. A book which has each topic so sub-divided and cross-indexed that a mere glance at a subject will give you any number of classifications and uses of it. For example, if you look at tubes, you find under this topic, various sub-titles, general, power, transmitting, photo-cells, testing of tubes, thyratons, etc. Every article or notice in the book has been considered so deeply important that when you refer to a certain classification, listed below the main topic, you will find perhaps a dozen or more articles treating the subject from different angles. The author in each case is given—the exact issue in which the article appeared, and on what page it is to be found. So accurately compiled, by C. W. Palmer, one of radio's foremost writers, that in less than two minutes you can turn to any article—needless to wade through all the issues of RADIO-CRAFT which have been published during the past three years.

The RADIO-CRAFT INDEX is exactly the same size as the monthly magazine—it has 24 pages. It can be conveniently kept on file with the copies of the magazine—ready for quick reference. The index is printed on good paper with self covers.

This book is sold only by the publishers at 25c the copy. Mail coupon below for your copy of the RADIO-CRAFT INDEX.

Briefly outlined below appears only a partial contents of the book

- | | |
|--|---------------------|
| AMPLIFIERS— | PATENTS— |
| ANTENNA SYSTEMS— | PHONOGRAPH REPRO- |
| CABINETS— | DUCTION AND RE- |
| CIRCUITS— | CORDING— |
| CODE— | POWER SUPPLY AND |
| COILS AND TUNING— | BATTERIES— |
| COMPONENTS— | RECEPTION— |
| COOPERATIVE LABORATORY— | REMOTE CONTROL— |
| DETECTORS AND RECTIFIERS— | SELLING AND MONEY |
| EDUCATION— | MAKING SERVICING— |
| INTERFERENCE AND HUM ELIMINATION— | SET CONSTRUCTION— |
| KINKS— | SPEAKERS AND REPRO- |
| MANUFACTURING— | DUCERS— |
| METERS AND TESTING EQUIPMENT— | TELEVISION— |
| MISCELLANEOUS— | TONE AND VOLUME |
| MOTION PICTURE RECORDING AND PROJECTION— | CONTROL— |
| MUSICAL INSTRUMENTS— | TOOLS— |
| NEUTRALIZING— | TRANSFORMERS— |
| NOVELTIES— | TRANSMISSION— |
| | TRANSMITTERS— |
| | TUBES— |
| | LIST OF BROADCAST, |
| | SHORT WAVE AND |
| | TELEVISION STA- |
| | TIONS— |

ABSOLUTELY NOTHING WHICH HAS APPEARED IN RADIO-CRAFT HAS BEEN OMITTED FROM THIS VALUABLE COMPILATION

Clip and Mail Coupon Today!

Publishers of RADIO-CRAFT, RC-533
96-98 Park Place, New York, N. Y.

Enclosed you will find my remittance of 25c (check, stamps or money order accepted) for which you are to send me, postage prepaid, one copy of the RADIO-CRAFT INDEX.

Name _____

Address _____

City _____

State _____

THIS BOOK CANNOT BE BOUGHT ON THE NEWS-STAND—ONLY DIRECT FROM THE PUBLISHERS THE COPY 25c

BUILDING AN ALL-PURPOSE TESTER

(Continued from page 659)

in the dark so far as the average Service Man is concerned—especially when new tubes, automatic volume control, and complicated circuits are involved. All this guesswork has been eliminated which not only makes this analyzer simple to build, but easy to operate, in a self-instructing manner.

The various socket holes, looking up and going clockwise, are correspondingly identified as filament plus, (FX); plate, (P); grid, (G1); grid, (G3); screen, (S); cathode, (C); filament minus (F-); and grid 2, (G2), the latter denoting the grid cap. The ground binding post is identified as Gnd. (See Fig. 2).

The various tube elements being thus identified are all connected to two sets of switches, which, in turn, are connected to the meter terminals. One of these switches consists of a rotary switch S1 named "Analyzer." This switch is usually kept in a certain position, such as the one marked "Gnd." The other switch (S14, S15... 21) can be easily identified as a bank of push-button switches on the bottom of the panel, Fig. A. Once a certain voltage range has been chosen with the "Volts" switch in Figs. 1 and 2, it is merely necessary to push any one of the switches just referred to (S14, 15... 21) to obtain the desired voltage reading to ground. Of course, all the readings can be obtained with respect to the cathode: for instance, by turning the "Analyzer" switch, S1, to the C (Cathode) position. It might be well to mention that all these voltage readings may be either A.C. or D.C. and that the polarity reversing switch, S9, can also be used for them.

(D) Current readings in four different tube element circuits may be obtained by bringing the rotary "Tests" switch, S4, into the M.A. (milliampere) position, and by throwing any one of the four M.A. toggle switches (S5, 6, 7, 8) in the "on" position. The "Milli-Amps" rotary switch, S3, permits the selection of any one of five milliamperage ranges: 0-1, 0-5, 0-20, 0-100, 0-250. See Fig. 3A. Two push-buttons (S12 and S13) identified as "Grid Tests" permit the so-called grid tests to be made. A separate 4½-volt "C" battery, E2, is provided for this purpose. (This battery insures greater circuit simplicity and less interdependence of one test setting upon another; it also practically doubles the life of one battery.) By pressing one of these buttons a change in plate current readings may be observed, which change in reading is commonly considered as the most satisfactory index of a tube's condition. (See Fig. 3B.) All D.C. and A.C. voltmeter ranges are protected by two suitable 10-amp. fuses, insuring endless life to the meter and rectifier.

Figure 2 serves not only as a complete schematic diagram, but, as it shows every single lug of all the parts used, it becomes at the same time a layout point-to-point diagram. Referring to the four pole rotary switch, S4, all indexes No. 1 refer to the first rotary section, all indexes No. 2 refer to the second rotary section, etc. All letter indexes refer to the same contact number of each rotary section.

A further inspection of the panel will reveal four pairs of uniquely designed binding posts identified as "Volts," "Milli-Amps" "Ohms," and "Impedance." Into these parts test prods must be inserted in order to obtain the corresponding external tests as follows:

(E) To make external A.C. and D.C. voltage tests, use the two upper right hand binding posts, BP 1 and 2, Fig. A, with the rotary switch S4, in the "Volts" position. The rotary switch, S2, marked "Volts," permits the selection of any of the following voltage ranges: 0-5, 0-10, 0-50, 0-100, 0-250, 0-500, 0-1,000 volts. To the left of this switch is a semi-rotary switch, S11, which permits a choice between D.C. or A.C. voltage readings. A polarity switch, S9, denoted as "Reverse," reverses the meter reading, should the test leads be used in a wrong manner.

The various voltage ranges are obtained with the aid of the rotary voltmeter switch S2, shown in Fig. 1, which introduces various resistors in series with the meter. As the meter employed is an 0-1 milliammeter, the voltage ranges obtained all have a total resistance of 1,000 ohms per volt on all D.C. ranges, and somewhat more on all A.C. ranges.

(F) To make external current tests, employ the two upper left-hand posts, Fig. A, BP5 and 6, marked "Milli-Amps." With the "Tests" switch, S4, in the M.A. position. A rotary

"Milli-Amps" Switch, S3, permits the selection of any one of the following ranges: 0-1, 0-5, 0-20, 0-100, 0-250 milliamperes. The reverse switch previously mentioned can also be used for the current readings.

Parallel shunts for the current ranges are in parallel with the meter resistance, thus making the total resistance of the corresponding milliammeter ranges even smaller than the shunt resistance itself, which is a decisive advantage, especially when testing output tubes having large plate currents. (Providing that a good, low-resistance shunt switch is employed, the milliammeter ranges may be extended into several amperes.) This makes the milliammeter of the low resistance type, having less than 1 ohm resistance for the 0-1000 ma. range, and permitting the reading of tube currents under actual operating conditions.

(G) To make resistance tests, employ the two lower right-hand binding posts, BP3 and 4, with the rotary "Tests" Switch, S4, in the "Ohms" position. A self-contained 4½-volt "C" battery and a bridge circuit are employed (as described further on and as shown in Fig. 3C), insuring permanent accuracy of the scale calibration, even should the battery voltage drop. A rheostat is provided to compensate for the latter. The scale is calibrated from 0 to 100,000 ohms. By turning the rotary "Tests" switch, S4, in the R/10 position, the range is reduced to 0-10,000 ohms, permitting the reading of such low resistance values as 5, 10, and 15 ohms. (Of course, much smaller values of resistors as well as resistors ranging up to several megohms, can be measured with a suitable external voltage source in conjunction with the largest current and voltage ranges of the analyzer.)

(H) To make impedance tests, use the two lower left hand binding posts BP7 and 8, with the rotary "Tests" Switch, S4, in the "Impedance" position. For making these tests it is necessary to employ 100-125-volt, 25-60 cycles, A.C.; hence the necessity of a conventional line cord and plug. A rheostat "Impedance-Adjuster" makes a zero impedance adjustment possible in order to compensate for various A.C. line voltages. As will be outlined further on, it is possible to measure capacity, and the impedances of choke coils, transformers, etc. The circuit is given in Fig. 3D.

For large impedances such as that of an impedance of a 0.01-mf. condenser, the unit under test is placed in series with a 50,000-ohm resistor and the A.C. line voltage. The meter itself has a 50,000 ohm series resistor, thus acting as a high resistance voltmeter and measuring the A.C. voltage across the impedance under test. This impedance may be that of a resistor, of a choke coil, of a transformer winding, of a condenser, etc. When the impedance toggle switch S10 is thrown to the low impedance range, the impedance under test is placed, in series with a total resistance of 100,000 ohms, across the A.C. line, and the meter is acting now as a low-voltage voltmeter. (Should a fully charged condenser be placed directly across the meter, it is protected against injury by a 1/100 amp. fuse, F2).

The meter scale itself is not calibrated in terms of impedances, but impedance curves can easily be drawn up with the aid of a few known values.

(I) The types of novel three-in-one binding posts and test-lead jacks employed are of interest; the tops of the binding posts used on the panel are equipped with tight gripping, self-contained jacks, into which can be inserted the spring constructed test-cord plugs. They allow almost instantaneous changeover from one test to another, by merely removing the test-cord plugs from one set of binding posts and inserting them into another. Both the binding posts and test jacks are multi-colored, making the polarity indication automatic. The binding post heads are, at the same time, of the screw-down type, and permit the horizontal insertion of any test leads, either through a traverse hole or by twirling around the threaded stem. When the test jacks are engaged into the binding posts, no metallic surface is electrically exposed, and loose metal parts or wires may fall safely on the analyzer panel without causing any electrical disturbance whatsoever.

(J) Point-to-point resistance measurements can be made in any chassis under test with this

(Continued on following page)

ELECTRICAL BOOKS



Here's great news for anybody interested in Electricity. BRAND NEW 1933 edition of Applied Electricity brought right down to date with every NEW Electrical subject fully covered. 10 big Volumes and all shipped FREE for examination.

FOR BEGINNERS AND EXPERTS

Over 3000 pages—hundreds of illustrations—the most complete work of its kind ever published. Dynamos, motors, power stations, radios, television, everything electrical explained clearly so anyone can understand them.

BIG FIELD! Big Demand!

Big Pay! Men who understand electricity are urgently needed right now in thousands of industries. Autos, airplanes, machine shops—practically every industry depends on electricity and men who know this subject make big money. Pleasant, fascinating work, easy to learn and do; learn quickly with these books. Send coupon for a set for FREE examination and see for yourself.

FREE [A year's consulting membership in the American Technical Society now given free to all readers of this famous Cyclopaedia of Electricity. Many say, "That's worth more than cost of books."]

AMERICAN TECHNICAL SOCIETY
Dept. E526, Drexel at 58th St., Chicago

AMERICAN TECHNICAL SOCIETY,
Dept. E526, Drexel at 58th St., Chicago
Send for 10 days' free use, BRAND NEW 10 volume set of Electrical Engineering. In return for mailing this coupon promptly, send absolutely free, certificate of membership in the American Technical Society entitling me to free consulting privilege for one year. I will pay the few cents delivery charges on the books. If I wish I may return them in 10 days and owe you nothing, but if I keep them I will send \$2.00 after 10 days, then \$3.00 a month until the special sale price of only \$29.80 is paid.

Name.....
Address.....
City..... State.....
Employed by.....
Address.....



RACON

TYPE "B" DYNAMIC UNITS
have been proven in the field

Compare these features:

Peak Power—50 watts
Continuous Power—30 watts
Five types for every purpose
Cadmium-plated—all metal
Wide-range quality.

Effective March 1, 1933, new lower prices on all units. Illustrated above—the type B Master—50 watts peak—\$40.00 list.

Write Dept. RC-3 for latest catalog of p. a. horns and units.

Racon Horns and Units are covered by U. S. Patents Nos. 1,507,711; 1,501,032; 1,577,270; 73,217; 73,218; 1,722,448; 1,711,514; 1,781,489; 1,832,408; 1,834,327; 1,835,739; 1,845,210; 1,878,360; 1,888,442.

RACON ELECTRIC CO., Inc.

52 East 19th St. New York, N. Y.

Build a TREASURE FINDER!



We supply
all Parts for Building
Electrical and Radio
**TREASURE
LOCATORS**

Radio, Audio, Ground Potential Measurements, Hughes Induction Balances and other types; including Oscillators and amplifying systems.

We supply all materials needed for building and operating any of the recognized treasure finders.

The following standard circuits are described in our bulletin:

- No. 1. Ground Potential, Leap-Frog Method.
- No. 2. Hughes Induction Balance Type A.
- No. 3. Hughes Induction Balance Type B.
- No. 4. Sensitive Hughes Induction Balance.
- No. 5. Simple Super-Sensitive Hughes Balance Circuit.
- No. 6. Radio Frequency Oscillator Circuit.
- No. 7. Audio Oscillator Circuit.
- No. 8. Single Search Coil Hughes Induction Balance with Audio Amplifiers.
- No. 9. Combination Radio Transmitter and Receiver circuit.

Also accessories such as High Frequency Buzzers, Audio Oscillators, Differential Current Transformers, Two Stage Audio Amplifiers, etc.

With any one of these systems you can locate buried treasures, metal war relics, mineral deposits, subterranean water veins, buried gas and water pipes, and lost objects, tools and treasures sunken in water, etc.

Write for pamphlet giving history and theory on this interesting subject. All above circuits and systems are described and explained. List of parts and prices included. (Price of pamphlet 10c.)

Mail Coupon TODAY!

GRENPARK COMPANY		Dept. RC
245 Greenwich St., New York, N. Y.		
Enclosed find 10c for which kindly send me pamphlet on Treasure Finders.		
Name	
Address	
City	
State	

analyzer with relative ease, due to the fact that all the analyzer tube sockets are normally electrically disconnected from the meter. In order to make these resistance tests, simply insert the analyzer plug, AP, directly into any receiver or amplifier socket. Now insert the test plugs into the "Ohms" binding posts, BP3 and 4. With the test prods fitting snugly into any two analyzer socket prongs, the D.C. resistance can be read directly on the meter.

(If the test jacks are inserted into the "Impedance" binding posts, the corresponding A.C. resistance can be obtained.)

(K) A ground binding post is also provided on the test panel with a corresponding lead and battery clip to permit similar resistance measurements between any one of the prongs and the ground or chassis connection of the unit under test. A great amount of time is saved thereby while trouble shooting, because it becomes now unnecessary to remove the unit under test from its original location in a cabinet or to be forced to get with the test prods into some practically inaccessible area.

List of Parts

- One Coast-to-Coast portable leatherette case, 12 1/2 x 13 x 4 3/4 ins.;
- One Coast-to-Coast black bakelite panel, drilled and engraved, 10 x 12 x 3/16 ins.;
- One Westinghouse 0-1 ma. universal Rectox rectifier, (calibrated in A.C. volts, ohms, and D.C. volts), model CX, M;
- One Eby bakelite base mount, 4-prong socket, model 5086, VT1;
- One Eby bakelite base mount, 5-prong socket, model 5087, VT2;
- One Eby bakelite base mount, 6-prong socket, model 6187, VT3;
- One Eby bakelite base mount, 7-prong socket, model 6187a, VT4;
- Eight Coast-to-Coast special three-in-one binding posts, type BPE619, BP1, 2, 3, 4, 5, 6, 7, 8;
- One Carter single-pole, nine-position rotary switch, model 4075, S1;
- One Carter single-pole, seven-position rotary switch, model 4074, S2;
- One Carter single-pole, five-position rotary switch, model 4073a, S3;
- One Carter four-pole, five-position rotary switch, model 4080, S4;
- Five H&H D.P.D.T. toggle switches, model 8351, S5, 6, 7, 8, 9;
- One H&H S.P.D.T. toggle switch, model 2196, S10;
- One Carter T.P.D.T. jack switch, model 7230a, S11;
- Two Carter D.P.D.T. push-button switches, model 7237a, S12, S13;
- Two Carter On-and-Off locking-type push-buttons, models 5081a, S14, S15;
- Six flush-mount buttons, model 4082, S16, 17, 18, 19, 20, 21;
- One Cinch ground binding post, model 3283, BP9;
- One Coast-to-Coast resistor, 19.75 ohms, R1;
- One Coast-to-Coast resistor, 4.16 ohms, R2;
- One Coast-to-Coast resistor, 0.798-ohms, R3;
- One Coast-to-Coast resistor, 0.317-ohms, R4;
- One Coast-to-Coast resistor, 275 ohms, R5;
- One Coast-to-Coast resistor, 2,210 ohms, R6;
- One Coast-to-Coast resistor, 2,000 ohms, R7;
- One Coast-to-Coast resistor, 2,500 ohms, R8;
- One Coast-to-Coast resistor, 5,000 ohms, R9;
- One Coast-to-Coast resistor, 40,000 ohms, R10;
- One Coast-to-Coast resistor, 50,000 ohms, R11;
- One Coast-to-Coast resistor, 150,000 ohms, R12;
- One Coast-to-Coast resistor, 250,000 ohms, R13;
- One Coast-to-Coast resistor, 500,000 ohms, R14;
- Two Coast-to-Coast resistor, 50,000 ohms, R15, R16;
- One Coast-to-Coast resistor panel;
- One Electrad 200-ohm, wire-wound rheostat, R17;
- One Electrad 4,000-ohm, wire-wound potentiometer, R18;
- One Alden 7 to 6-prong analyzer plug with center pin and grid cap, model 7218a, with 9-wire cable, 5-feet long;
- One Alden 6- to 7-prong adapter, model 7221b;
- One Alden 6- to 5-prong adapter, model 7221a;
- One Alden 6- to 4-prong adapter, model 7222;
- One pair Coast-to-Coast test leads with band-spring chuck prods;
- Two Burgess 4 1/2-volt "C" batteries;
- One line cord with rubber plug;
- Two Littlefuse .01-amp. fuses, type 1001, F1, F2;
- One Coast-to-Coast impedance chart, output meter chart.

\$500.00 IN PRIZES!

WHAT BEST is the Title

for the picture below?

25c A COPY



At All Large Newsstands 4-Color Cover 9"x12" in Size Over 200 Illustrations

RAPIDLY increasing each day are the number of experiments in the Short-Wave field—developments which are bringing to this branch of radio thousands of new "thrill seekers." Experimenters, as in the early days of Radio, again have the opportunity to bring about stirring new inventions. Read in **SHORT WAVE CRAFT**, the Experimenter's Magazine, how you can build your own Short-Wave Sets, both transmitters and receivers. **SHORT WAVE CRAFT** is exclusively a short-wave magazine—the kind you have wished for so long.

Interesting Articles in the Current Issue

- A Three Tube "Stand-By" From A Radiola V, by A. R. Appelman.
- A "Plug-less" 3 Tube S-W Receiver.
- A Brand New Style Short-Wave Call List, With Calls, Frequencies, etc., In bold type.
- How To Get A License For Amateur Radio Stations, by "Bob" Hertzberg.
- 12,500 Miles On "Loud Speaker"—All On 2-Tube Oscillodyne—Verified by the Editors.
- New "Dual Channel" S-W Receiver—which permits you to hear "both ends" of phone talk, by C. E. Denton and L. W. Orton.
- The "Easy-Build" S-W Super-regenerator.
- \$5.00 Monthly Prize For Best S-W Kink.
- Short-Wave "Question and Answer" Box
- Short-Wave Beginner, by C. W. Palmer.

SPECIAL OFFER COUPON

SHORT WAVE CRAFT RC-533
98 Park Place, New York, N. Y.

GET ACQUAINTED OFFER

- As per your Special Offer, I enclose \$1.00 (Canada and foreign \$1.20) for which enter my subscription to **SHORT WAVE CRAFT** for 8 months. (I understand that your regular rate for a year's subscription is \$2.50.)
- Mail me a sample copy of **SHORT WAVE CRAFT** for which I enclose 15c (U. S. Stamps or coin accepted).

Name
Address
City State

Here's a book every Radio Man will refer to dozens of times every day—



A Valuable RADIO BOOK!

HERE is one radio book that answers every conceivable question on interference. It contains 76 pages, 8½x11 inches, chock full with wiring diagrams, drawings and photographs showing where interference originates—how it is distributed, and how to eliminate it. This is a wealth of information needed by every radio listener, dealer and Service Man.

Send fifty cents in stamps or check for this book.

RADIO-CRAFT MAGAZINE
96-98 Park Place New York, N. Y.

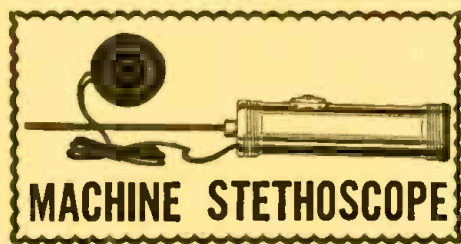

MACHINE STETHOSCOPE
Gives inside information on all running machinery Build it yourself

All you need is an old Flashlight, a SKINDERVIKEN Button and a phone receiver.

Full details of instruction and blueprint showing where and how to listen, also chart indicating character of noise in automobile chassis and motor.

OTHER USES FOR SKINDERVIKEN TRANSMITTER BUTTONS:
RADIO AMPLIFIER PHONOGRAPH AMPLIFIER
DETECTOGRAPH TELEPHONE AMPLIFIER
(Dictograph) LOUD SPEAKER AMPLIFIER
HOME RECORDER CRYSTAL SET AMPLIFIER
LAPEL MIKE

16 PAGE INSTRUCTION BOOKLET containing suggestions and diagrams for innumerable uses, furnished with each Skinderviken Button **95¢ ONLY**

Our Microphone Transmitter is the original SKINDERVIKEN Button; it is the smallest microphone made, measuring only ¼ inches in diameter. It is filled with the finest polished carbon grains obtainable. —ULTRA SENSITIVE—

USE COUPON—SEND NO MONEY
When the postman delivers your order you pay him for whatever you have ordered, plus postage.

PRESS GUILD, Inc. RC-533
16 Murray St., New York, N. Y.

Please mail me at once as many of the following Skinderviken Microphone Buttons as I have indicated.

One for 95c; Two for \$1.75;
 Three for \$2.50 Four for \$3.20

I will pay the postman the cost of the items as specified, plus postage.

Name _____
Address _____
City _____ State _____

RADIO-CRAFT for MAY, 1933

READERS' DEPT.

(Continued from page 689)

A 110-VOLT D.C. "MEGADYNE"

Editor, RADIO-CRAFT:

I built your one-tube loudspeaker set published in RADIO-CRAFT. However, I did not want to be bothered with batteries, so I incorporated a few extra parts and hooked it all up for 110 V. D.C. operation as per Fig. 2; and I must say it is all that you claim for it. Selectivity is fair, plenty of pep, and has absolutely no hum. The value of resistor R, for the filament, was a bit troublesome, so I tapped along a 2,000 ohm, bare wire-wound resistor, using a meter, until I got just 6 V. on the filament. I should say this set is a little wonder. Would you mind passing it on to the boys?

J. DaCosta,
223 E. 117 Street,
New York City.

(Here it is. We are glad that Mr. DaCosta has had such success in revamping the "Megadyne," originally described in the July, 1932 issue of RADIO-CRAFT.—Technical Editor.)

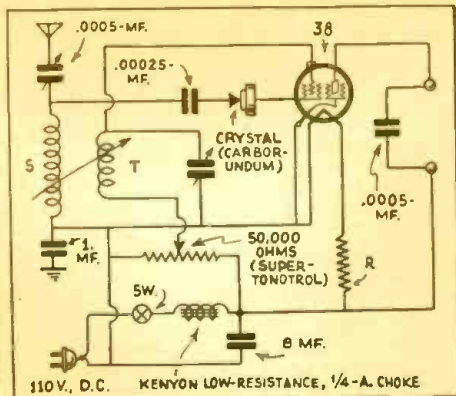

Schematic circuit of the D.C. power-operated Megadyne receiver. We have received so many requests from readers who desire to operate this excellent receiver from D.C. power supply, that we are pleased, indeed, to incorporate this circuit in our pages.

CONCERNING "MORE TUBES?"

Editor, RADIO-CRAFT:

I for one am heartily in accord with your suggestion as to the "Portable Series of Tubes." My idea is that the filament current be made as low as tube efficiency will allow. The voltage of course should be such as to permit the tubes to be operated from one or more dry cells in parallel.

Now let me ask some questions about a tube. In the May, 1932, issue, Mr. Martin told of a new combination detector-oscillator tube, which he called a septode. In this section of the country nothing has been seen or heard of it to date.

Is this tube in production as yet? If so, could you tell me the manufacturer's name and also the list price of this tube? If this tube is not now manufactured, is it dropped permanently or temporarily?

As to my reason for asking I am considering building the cheapest, most sensitive "super" possible, and would like to get this tube, as otherwise I will have to use a type 57 tube as the detector-oscillator.

H. MCKNIGHT,
R. F. D. 4,
Buhl, Idaho.

(The laboratory-model tube to which Mr. McKnight refers was changed slightly in the production model and is now available as the type 55 with a 2.5 V. filament, and the 85 in 6.3 V. design; however, the low mu (about 8.3) of the triode section resulted in the development of the still more recent type 75 tube (with a mu of 100) described in the April, 1933, issue of RADIO-CRAFT.—Technical Editor.)

ADDING A BAND-SELECTOR TO THE "PENTODE PORTABLE"

Editor, RADIO-CRAFT:

I have read from time to time of the different versions of the justly popular "Pentode Portable," and so wish to pass on to others what I have been doing along the same line.

(Continued on following page)

MULTITESTER

Knock down kit, net **\$15**
(less batteries and test prods)
List \$27.50

Completely wired and assembled, net **\$20**
(Includes batteries and test prods)
List \$37.50



FEATURES — Triple Range Ohmmeter, ½ to 2,000,000 ohms Four Range Voltmeter, 1/10 to 750 volts—Triple Range Milliammeter, 1/10 to 250 milliamperes—1000 ohm per volt sensitivity —Automatic Selector Switch connects meter to proper circuit and scale and totally disconnects from all others.

Double Range Ohm Meter and Circuit Tester ½ to 200,000 ohms Complete **\$11.95** Net

Super Test Unit

Super-flexible analyzer unit for use with any meter or with Multitester. Permits all point to point resistance measurements and all voltage—current measurements. 36 different voltage or resistance readings available at one socket. Spare provision for 9 more readings. Includes 7 prong analyzer plug with adapters and 10 wire cable. **\$13.50** Net

List \$25.00

Send for bulletins on Testing Equipment.

RADIO CITY PRODUCTS CO.
48 WEST BROADWAY NEW YORK, N. Y.

AERO INTERNATIONAL ALL WAVE 11-TUBE

SUPER-HETERODYNE DE LUXE



Completely Assembled With 2 Matched Full Dynamic Speakers **\$29.75**

At last! World wide reception at a sane price. 15 to 550 meters. Besides the regular broadcast band, it brings in foreign programs, amateurs, police calls, ships at sea and aeroplanes. One dial control. No plug in coils. Latest super-phonics tubes.

AERO 4-TUBE MIDGET

\$10.95 less tubes \$2.95 kit of tubes



The lowest priced quality Midget Receiver on the market today. Very selective, brings in long distance like local stations.

AERO 5-TUBE MIDGET...\$11.90
AERO 6-TUBE MIDGET... 18.50

AERO WORLD WIDE



I-Tube SHORT WAVE SET for Head-phone Operation **\$5.95**

Listen in DIRECT to London, Paris, Berlin, Buenos Aires and other broadcasting stations throughout the world via short waves. Your ordinary receiver cannot tune in these low wave stations. **WORLD-WIDE RECEIVER** gets 15 to 500 meters. Aero 2-Tube Short Wave Set \$8.75. The same as above set but it has 1 stage of Audio Frequency added to it.

Write for Complete Catalogue **CHARLES HOODWIN CO.**

4240 Lincoln Ave., Dept. B-17 Chicago

691

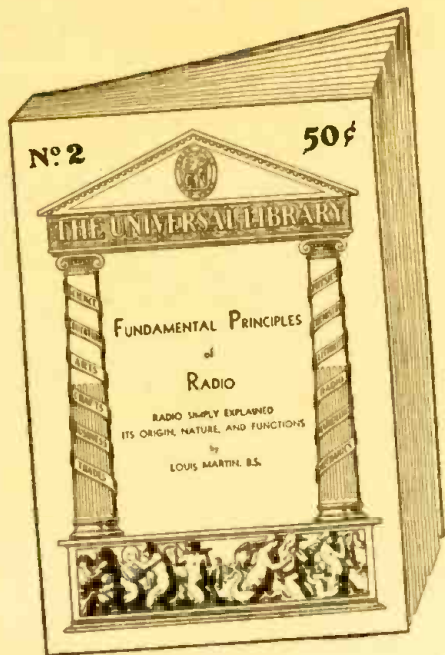

No. 2
FUNDAMENTAL PRINCIPLES OF RADIO

Radio Simply Explained—Its Origin, Nature and Functions

By LOUIS MARTIN
 Prepared with special consideration given to young members in the radio profession, and those who have gained their experience in a haphazard fashion. This radio primer is a handy fundamental aid for "checking up" and systematizing your knowledge of radio. Regardless of how much you know about the subject, you should read this book.

PARTIAL CONTENTS:

Chapter I—Fundamentals of Radio: Electricity, Resistance, Batteries, The Magnetic Circuit, The Magnetic Field, Inductance, Condensers, A.C. Circuits, Propagation of Radio Waves; Chapter II—The Simple Radio Set, Single, Two, and Three-Circuit Tuners, The Battery Set, Vacuum Tubes, Electric Sets, Loud Speakers; Chapter III—Diagrams, How to Read Them; Chapter IV—Amateurs and Broadcast Stations, Talking Pictures, Television.

No. 1
FORMULAS and RECIPES

For the Practical Man
 By S. GERNSBACK

An extremely helpful book showing you how to save money by making in your own home, at a fraction of the regular cost, the hundred and one preparations which you now buy for use at home or business.

PARTIAL CONTENTS:

1. Adhesives; Glues; Cements. 2. Cleansing; Stain Removers; Bleaches. 3. Metal Craft; Coloring, Oxidizing, Plating, Polishes. 4. Paints; Colors, Stains, Varnishes. 5. Glass-Working; Cutting, Drilling, Boring, Etching, Engraving. 6. Wood-Craft; Fireproofing, Acid-proofing, Waterproofing, Furniture Polishes. 7. Inks; Sympathetic, Indelible, Hectograph. 8. Photography; Developers, Emulsions, Fixers. 9. Antidotes for Poisons. Remedies for Burns and Scalds. Disinfectants. 10. Preparation, Manipulation, Handling, Mixing. Tables of Weights and Measures. Useful Tables.

No. 3
ELEMENTARY MATHEMATICS

for the Technician and Craftsman

By C. SHAINMARK

This manual has been especially prepared for the man who wishes to acquire a working knowledge of the elementary principles of mathematics. A complete treatment of the subject is given by the author, Mr. C. Shainmark, with special attention to the use of mathematics in Radio and other technical work for those who employ its formulas daily.

PARTIAL CONTENTS:

I—Arithmetic: Addition, Multiplication, Subtraction, Division, How to Use Decimals; II—Fractions, Percentages, Ratio and Proportions; III—Powers and Roots; IV—The Metric System; V—How to Measure Surfaces and Volumes; VI—Mathematics for the Manual and Technical Craftsman; VII—Special Mathematics for the Radio Technician; VIII—Commercial Calculations, Short-cut Arithmetic, Interest Calculation, Discounts; IX—Weights and Measures; X—Useful Tables.

All our books are of uniform size, 6 x 9 inches, and contain 64 pages. The books are printed on strong paper with stiff colored covers.

PRESS GUILD INC., 16 Murray St., New York, N. Y.

ANY TWO BOOKS FOR 85¢

ALL THREE BOOKS FOR \$1.25 postpaid.

Enclosed find \$_____ for which mail me postpaid the following books:

No. 1 No. 2 No. 3
 Single copy 50¢ Postpaid

Name _____

Address _____

City and State _____

RC-533

Here in Pittsburgh, I found that after building this set I didn't have the selectivity that I wanted, so I added a band-selector feature. Then, being a short-wave fan, I added a D.P.D.T. switch, and then could tune down to the police waves and the 160 meter band for amateurs. The result is a set that can do more than some of its big brothers.

The circuit, below, is the usual band-selector arrangement. Coils L1 and L2 have 44 turns of No. 30 D.C.C., tapped at the 20th turn from the ground end. A D.P.D.T. jack-switch covers the two coil ratios. The tickler, L3, has 20 turns of 30 D.C.C., although experiment is advisable. The rest of the set is the same as the original "A.C. Pentode Portable," described in the September, 1931, issue of RADIO-CRAFT.

The spacing between the whole of L1 and L2 is one inch for the broadcast band. When the set is switched to the low-wave position, this distance is greater, giving desired selectivity on the 160 meter amateur band.

By bank-winding L1 and L3, the original compactness is preserved, and the only addition to the original set would be the midjet two-gang condenser and D.P.D.T. switch.

I hope that this version will be of interest to your readers, and that they have as much fun out of this design as I have.

RICHARD O. LAMB,
 1039 S. Trenton Ave.,
 Wilkensburg, Pa.

(Mr. Lamb has added his name to the very long roster of those who are "tickled pink" with the performance of their "Pentode Portable," the original description of which appeared in the August, 1931, issue of RADIO-CRAFT in the article, "The RADIO-CRAFT Pentode Portable."—*Technical Editor.*)

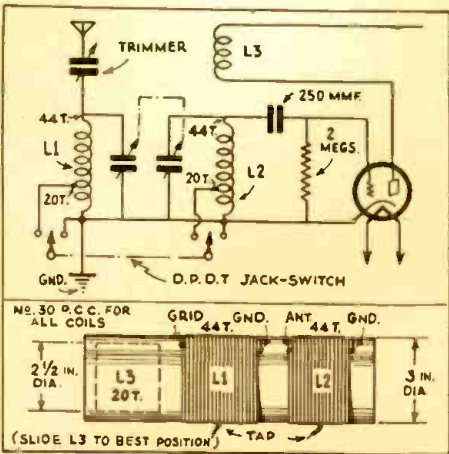

RADIO—LANGUAGES' STEAM ROLLER

Radio will in time polish off local dialects and at the same time make the common language richer in words and their use more accurate, predicts Professor Otto von Friesen of the University of Upsala, who is an internationally known linguist and a member of the Swedish Academy which annually picks the winner of the Nobel Prize in literature. What he says about the effect of broadcasting in Sweden holds true, of course, in other countries.

Like most lands Sweden has many dialects and when a person speaks on the national radio program it is often possible to tell from his enunciation what province he comes from. It is the deliberate policy of the Swedish broadcasting service, which is under the control of the press, to admit all and every dialect and not attempt any restriction of its speakers to those who were born in Stockholm, for instance.

In Germany the speech of the stage has become the standard for good spoken German, and how much more important the radio broadcast which reaches so many more people, will be for the future development of our tongue. Not that we may look forward to anything that might be called "Radio Swedish," but the radio will gradually smooth out the various dialects and intonations into a more national speech.

The country dialects have also preserved many old words which the national language has dropped and radio may bring back those which still serve a purpose. The Swedish radio chiefs believe, furthermore, that the pronunciation of foreign words will be improved by the radio.

THE ORSMA BULLETIN

THE BIGGEST NEWS-MAGAZINE IN THE RADIO INDUSTRY

Issued Monthly for Radio Service Men

This new magazine is filled with interesting service information; plans of the Association; Service Men's experiences; answers to inquiries about servicing; hints on making extra money in the servicing field, in short, it is a magazine written for and by members of the ORSMA. It is the voice of the Association in which the problems and suggestions of the individual members are presented for review and discussion among the fraternity. It is a magazine for, of and by the Service Man, edited by the staff of RADIO-CRAFT Magazine, sponsors of the OFFICIAL RADIO SERVICE MEN'S ASSOCIATION.

In appearance this BULLETIN is made up in the style and size of a tabloid newspaper. It contains up-to-the-minute service information. A partial contents of the average issue is found below:

EDITORIAL.—Advice to the young Service Man—How to get started.

SERVICING EXPERIENCES.—The methods used to overcome unusual and difficult service jobs. SERVICE MEN'S EQUIPMENT.—Favorite testing units of "veteran" Service Men.

EXPOSING THE SERVICE "GYPSY"—A continuation of the war against dishonest service work. THE SERVICE MEN'S OWN FORUM.—There the views and problems of the members may be "aired."

ELECTRIFYING AND MODERNIZING OLD RECEIVERS.—As a source of income for the Service Man.

MAKING MONEY AT SERVICING.—Methods of advertising and extending business employed by successful Service Men.

THE RADIO SERVICE MEN'S BUYING GUIDE.—A classified directory of radio manufacturers and supply companies which allow special discounts to Members.

THE QUESTION BOX.—Questions asked by Service Men and the answers.

EMPLOYMENT SERVICE.—Ads inserted by companies in need of Service Men and Members looking for employment.

Subscription Rates for the ORSMA BULLETIN

ORSMA Members		Non-Members
50c	one year	\$1.00
\$1.00	two years	\$1.75
\$1.50	three years	\$2.50
\$2.00	four years	\$3.00
\$2.50	five years	\$3.75

Price of Single Copy 10c

Subscription Blank

Executive Secretary O. R. S. M. A.,
 98 Park Place, New York, N. Y.

Enclosed find my remittance of \$_____ for which please enter my subscription to your BULLETIN for _____ years.

I am a member of The Association and my Membership Certificate number is _____.

I am not a member, but would like to receive your application blank to join the O. R. S. M. A. (no fees—no dues to be paid by me).

Name _____

Address _____

City _____ State _____

CLASSIFIED ADVERTISEMENTS

Advertisements in this section are inserted at the cost of ten cents per word for each insertion—name, initials and address each count as one word. Cash should accompany all classified advertisements unless placed by a recognized advertising agency. No less than ten words are accepted. Advertising for the June 1933 issue should be received not later than April 9th.

CHEMISTRY

BECOME A TRAINED CHEMIST. Thousands of opportunities—fascinating career. Learn at home. Complete experimental laboratory outfit given. Write for big free book. Chemical Institute, 19 Park Place, Dept. RC, New York.

DOGS

BEAUTIFUL Registered bull pups, \$15. Bull-dogs. 501-RC, Rockwood, Dallas, Texas.

INSTRUCTION

CANADA'S Oldest and best equipped radio school offers complete course covering Radio, Television, Sound Amplification, etc. Approved by leading radio manufacturers. No duty or exchange to pay. Radio College of Canada, Limited, 310 Yonge St., Toronto.

MEN—WOMEN, 18-50 WANTED. Qualify for future Government Life Jobs. \$105.00-\$175.00 month. List positions FREE. Write today sure. Franklin Institute, Dept. J77, Rochester, N. Y.

RADIO

MAGNETIC Speakers rewound and adjusted, \$1.25. Radio Service, Flora, Indiana.

GUARANTEED "Pocket Radio," \$2.00. Catalog, 10c. Neil Tasker, Shamokin, Pa.

TRANSFORMERS REWOUND, varnished, baked, guaranteed, reasonable cost. **SPEAKER REPAIRING,** magnetic \$2.00-\$2.50; dynamic, voice coils, fields, etc., reasonable charges. Clark Bros. Radio Co., Albia, Iowa.

TRANSFORMERS AND SPEAKER FIELD COILS rewound or made to order. Transformer and complete instructions on rejuvenating of AC tubes \$4.00 postpaid. 5 hours service. Pemberton Laboratories, 921 Parkview, Fort Wayne, Indiana.

SENSATIONAL MICROPHONE VALUE— Universal Model "Y"—Experimenters single-button, watch model type. 200 ohms. Pure Gold Spot Center Diaphragm. Only \$2.00, including valuable 1933 general catalog with diagrams. Universal Microphone Co., Ltd., Inglewood California.

MAJESTIC "A" AND "B" ELIMINATORS cheap. E. Tischler, Plymouth, Pa.

CHEMISTRY

A New Plan to Become a
TRAINED CHEMIST

\$6.25

By taking only one step at a time—as your means permit—you can give yourself the benefit of the most complete, thorough-going, up-to-the-minute education for skilled well-paying professional work, in the most fascinating of all scientific fields, through our famous

COURSE IN PRACTICAL CHEMISTRY

Write TODAY For Information

Chemical Institute of New York, Inc.

Founded 1921

HOME EXTENSION DIVISION

19RC Park Place

New York, N. Y.

TO ALL RADIO MEN!

The advertisements which appear on pages 688 and 689 of this issue is extremely important. Everyone should turn to these pages NOW and read them carefully.

LISTENER'S FORUM

(Continued from page 675)

land, Ore.: KGPA, Seattle, Wash.; KGPW, Salt Lake City; KGPE, Kansas City, Mo.; KSW, Berkeley, Calif.; KGPX, Denver, Colo.; and many more.

I also get airplane and airports, some, far East. The set is a wonder. I use the crystal set as a tuner unit, no R.F. amplification whatever.
H. H. HULME,
Glenyon Ranch,
Post Falls, Idaho.

HE KNOWS WHEN TO HUNT

Editor, RADIO-CRAFT:

In reply to your request for unusual DX records, allow me to tell of the unusual record I have made. My Majestic table model is just 20 days old. Without ever experimenting with the aerial, except to shorten it, and without DXing in the early morning, I have increased my DX total from 205 to 360 stations in 14 countries. My best catches are as follows: CPX, Bolivia; CX20, Uruguay; YVIBC, Venezuela; LR4, Buenos Aires; LR6, Buenos Aires; EAJ7, Spain; Radio Budapest (545 Kc.); SCW, Sweden; SCK, Sweden (250 watts); all before 11 P. M. in the evening.

My success is due mainly to knowing when and where to look for stations, the new tubes, and a bi-directional aerial, and luck, not skill.

ROBERT ROSENBERGER,

17 Janssen Pl.,
Kansas City, Mo.

(Here is a real goal to shoot for. You'll have to do some fancy tuning.—Editor.)

SOME LOW POWER CATCHES

Editor, RADIO-CRAFT:

I am writing to tell you about the results I have enjoyed with my radio. I have had my set for thirteen weeks; I bought it second hand and to date 111 stations have been tuned in.

Here are some of the best—WPEN, Philadelphia, Pa., 250 watts; WOL, Washington, D. C., 100 watts; WSPA, Spartanburg, S. C., 250 watts; CMBY, Havana, Cuba, 350 watts; and KFVD, Los Angeles, Calif., 1000 watts. Station KHJ in Los Angeles, Calif., and station XER in Villa Acuna, Mexico, can often be picked up before 9 p. m.

I have heard every channel except 10 of them. They are 1440, 1340, 1280, 1180, 1120, 1050, 1030, 1010, 960 and 560 kilocycles. I have only used the set for a little over two months, though, and I hope to have a station for each channel before long.

I would like to hear from other DXers to compare records and swap experiences.

J. S. GORAL,
Latrobe, Pa.

(Thanks for your letter, J. S. You have a very good record for such a short time. Your request for letters from other DX fans is a good one. Anything that will bring listeners closer together will certainly be for their benefit. We might add that we will be glad to forward any letters addressed to Mr. Goral or any other contributor to this column. Just address the letters in care of the DX Editor, RADIO-CRAFT, 98 Park Place, New York.—Editor.)

TOBE PRIZE CONTEST

Every radio dealer and Service Man will be interested in the news that a prize contest, entirely within the radio industry, is to be sponsored by the Tobe Deutschmann Corporation of Canton, Massachusetts. This contest, which is open only to bona fide radio Service Men and dealers, will result in the distribution of one hundred valuable prizes, including the latest types of radio interference locating apparatus, service instruments, condenser kits, radio magazine subscriptions, etc.

The object of the contest is to familiarize the radio industry with the newest developments in the Tobe condenser line. Although many radio men, especially the younger ones, know the Tobe Deutschmann Corporation chiefly through its radio noise eliminating devices, this concern has been manufacturing high quality condensers for many years.

Full details of the Tobe Condenser Contest may be obtained from leading radio parts jobbers or by writing to the Contest Director of the Tobe Deutschmann Corporation.

RCA INSTITUTES

Recognized Standard in Radio Instruction Since 1909

Technical Training Courses in Radio and Associated Electronic Arts

Practical Radio Engineering
Sound Engineering
Broadcast Transmission
Radio Servicing
Commercial Radio Operating

Resident Schools at New York and Chicago

EXTENSION COURSES for HOME STUDY under new "no obligation" plan, with privilege upon graduation of 2 weeks' intensive practical training without charge at either Resident School.

Mail Coupon for Illustrated Catalog

RCA INSTITUTES, INC.,
Dept. RT-5
75 Varick Street, New York, N. Y.
1154 Merchandise Mart, Chicago, Ill.

Please send with no obligation to me:
() Illustrated catalog and information about resident school courses.
() Information about extension courses for study at home, together with illustrated catalog.

Name..... Age.....
Address.....
City..... State.....

THE NEW SHALLCROSS A.C. UTILITY METER No. 685



CAPACITY
0.005 Mfd. to 10 Mfd.

INDUCTANCE
.5 Henrys to 10,000 Henrys

RESISTANCE
25 ohms to 5 megohms.
A.C. voltage ranges
0-10-125-500-1000
1000 ohms per volt.

This instrument is very easy to build. The important parts required are a 1-milli-ampere A.C. (rectifier type) meter and the SHALLCROSS Resistor Kit No. 685 with meter scale.

Send 6c in stamps for Bulletin 685-P describing this useful test instrument.

Shallcross Mfg. Company
ELECTRICAL SPECIALTIES
700 PARKER AVENUE
Collingdale, Pa.

WANTED

Smart service men who realize the money possibilities in plugging Amperite. It improves the sets you service; saves the customer at least 10% on electric current. You make \$1.85 clear profit on each sale. Amperite Corporation, 561 B'way, New York.

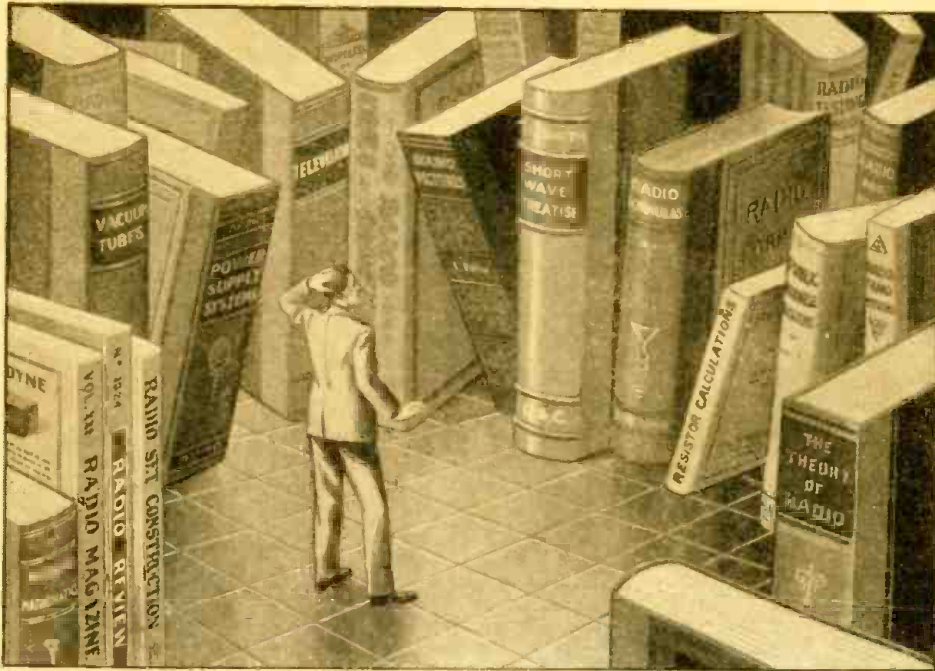

You want to get the exact and technical meaning of a word or phrase in radio! You are in doubt about a radio formula or radio circuit! You look through a maze of books and magazines losing your time and your temper. Why not have at your desk or in your library a copy of

S. GERNSBACK'S RADIO ENCYCLOPEDIA

THIS book is the NEW EDITION OF THE FAMOUS FIRST RADIO ENCYCLOPEDIA by S. Gernsback, the first book of its kind ever published in America.

The new Second Edition is fully revised, rewritten, and enlarged. It is absolutely the up-to-the-minute new model of the pioneer First Radio Encyclopedia, which became the stand-by of all radio men in every part of the world.

2,201 RADIO DEFINITIONS
1,253 TECHNICAL ILLUSTRATIONS
34 TABLES AND CHARTS
24 PAGES OF APPENDIX

Red Morocco-Keratol Flexible Binding

Printed on strong ledger paper.
Loose-Leaf Arrangement
352 pages. 9x12 in. Weight 3 lbs.



\$3.98

39,000 Bought the First Edition!

S. GERNSBACK CORPORATION,
98 Park Place, New York, N. Y.

NEW SELLING PLAN

Send me one copy of the new Second Edition S. Gernsback's Radio Encyclopedia with the privilege of inspection. If I like the volume, I will pay Expressman \$3.98 plus shipping charges.

Name

Address

City State

RC-533

FOR SALE, BARTER AND EXCHANGE

As an aid to our readers, all advertisements to be inserted in this department are accepted at 2c a word; name, address, street number, etc., each counting for one word. No advertisement for less than fifteen (15) words accepted.

The Publishers are not responsible for difficulties arising out of the trades. In this department, only advertisements for private individuals can be accepted.

RADIO-CRAFT reserves the right to reject any advertisement that conflicts with the policy of this magazine. Send all "Swap" advertisements to RADIO-CRAFT, 96-98 Park Place, New York, N. Y.

Have one Lacault Ultradync, one of the finest Superhets made. Famous for long distance receiving. Have also small Short Wave Converter. Send \$25.00 cash for both. Write, T. Epstein, 7 West 22nd Street, Suite 1009, New York, N. Y.

Have 72-inch R.C.A. Victor exponential horn, with electric and acoustic tone-arm pick-ups. First check \$25.00 takes it. Crossman air gun, .22 calibre shoots like a regular bullet rifle, cost \$17.50—will sell for \$7.00. H. Ackerson, Island Road, Ramsey, N. J.

Stewart-Warner 8-tube broadcast set, table model No. 801B, original price \$89.50. Will sell for \$12.00. Itebent Short Wave Converter, 3 tubes, with power supply and automatic switching arrangement, 10 to 200 meters, brand new, never used, cost \$25.00, will sell for \$7.50. Zenith, model ZE220 chassis, 36 in. long, 10 tubes, T.R.F., slightly used, including tubes, equipped with two horns, comes with model ZE1 battery eliminator, with Raytheon tube, also Westinghouse Rectox trickle charger, original price \$500.00, will sell for \$40.00. A. Ribarsky, 180 Riverside Drive, New York City.

One television scanner comprising synchronous motor, 60 hole scanning disc, first come, first served, \$7.00. Have one brand-new Workrite short wave converter \$65.00, first check for \$8.00 takes it. Ellis, North Central Ave., Ramsey, N. J.

HAMMARLUND HI-Q 30, D.C. model, for sale. Seven tubes: two 227's, two 224's, and two 255's in push pull. Uses dynamic speaker and has facilities for phonograph connections. A remarkably sensitive receiver. List of chassis, \$150. Will sell for \$10 cash. A real bargain! L. Abitsch, 736 West End Ave., New York City.

ULTRA-MODERN SUPER. All parts for this famous set mounted on a cadmium-plated chassis and partly wired, for sale. Only manufactured parts used; everything in excellent shape. Set described in October Issue of this magazine. Price, \$20.00. First money takes it—a real buy. Z. Martin, 415 Lefferts Ave., Brooklyn, New York.

HAMMARLUND "AIR-TUNED" TRANSFORMERS

A departure from present design is presented in a new group of air-tuned intermediate frequency transformer and oscillator units developed by the Hammarlund Manufacturing Company, 424 West 33rd Street, New York, N. Y.

The transformer is of the tuned primary-tuned secondary type, with both plate and grid coils tuned to resonance by means of air-dielectric variable condensers of special design. These condensers are mounted on an Isolantite panel 1 1/8" in diameter. The rotor is carried in a single bearing in the Isolantite panel and consists of two circular and three semi-circular brass plates of 3/4" radius riveted to the rotor shaft. The stator, also of brass, consists of two circular and two semi-circular plates soldered to stator support rods, which in turn are soldered in the bushings in the Isolantite panel. Contact is made to the rotor plates by phosphor bronze spring under considerable tension. No locking device is necessary, as the tension of the contact spring is sufficient to maintain the setting of the rotor even where extreme vibration is present.

A screw driver slot is provided in the end of the rotor shaft to facilitate tuning.



The use of these air variables practically eliminates the variations in gain and selectivity inherent in I.F. transformers in which the coils are tuned by means of adjustable condensers of the compression type using mica as dielectric. Even when such condensers are built on Isolantite bases and the highest grade mica is used, variations in temperature and relative humidity causes changes in both the capacity and power factor sufficient

to render them unfit for use in precision equipment. The change in capacity is especially troublesome in transformers operating at the higher intermediate frequencies, where a given percentage change in capacity causes a relatively great change in I.F. transformers when expressed in kilocycles.

For instance, variations in capacity of as much as 3% between the six compression type mica condensers used in a two stage (3 transformer) intermediate amplifier are not uncommon during a spell of high relative humidity. Since the percentage change and resonant frequency of a circuit is equal to one-half the percentage in capacity, for small changes only, this represents a frequency drift of 1 1/2% or 7 kc. in the case of a 465 kc. amplifier such as is used in the "Pro." A large increase in losses invariably accompanies this capacity change due to moisture absorption. The mis-tuning, plus the increase in power factor, causes a marked decrease in both selectivity and amplification.

CHECK FILAMENT DRAIN*

When tubes are used in a parallel connection the variation in filament current does not play such an important part upon their life. However, when tubes are connected in series the filament current draw for every tube should be identical, otherwise, the tube designed to carry the smallest filament current will be subjected to the greatest strain and is likely to burn out long before it would under normal conditions.

Some tube manufacturers are turning out 6.3 volt heater type with a rated filament current of 400 mils while others are rating their filaments at 300 mils. Where these tubes are connected in series, the 300 mil tubes are seriously overloaded if enough current is passed through the circuit to operate the 400 mil tubes normally.

Even where tubes are connected in parallel and all are supplied by a given voltage, filaments having too low or too high a resistance will change the performance of the receiver very materially.

*Triad Mfg. Co.

In ST. LOUIS



THE AMERICAN HOTEL
275 ROOMS WITH BATH
\$2.00 UP



THE ANNEX
226 ROOMS WITH BATH
\$1.50 UP

The AMERICAN HOTEL
MARKET AT SEVENTH

The AMERICAN ANNEX
MARKET AT SIXTH

Our Food has made our Reputation
COFFEE SHOP OPEN UNTIL MIDNIGHT

HELLO AMERICA!!
IT'S HERE!
NEW YORK'S MOST SENSATIONAL
Cabaret Restaurant
FEATURING
JAMES HALL
(Movie Star of Hell's Angels)
AND HIS MARDI GRAS ORCHESTRA
Dine in an Atmosphere of Far Away Monte Carlo While You Enjoy Bobby Sanford's
WHEEL OF DREAMS
Broadway's Smartest Floor Show With a Host of Popular Favorites and
40—GORGEIOUS GIRLS—40
Phone Anyone—Anywhere from the Telephone On Your Table
DINNER—\$1.50

Monte Carlo Casino
48th Street West of Broadway
Reservations—Lackawanna 7111
NO COVER CHARGE EVER

The Hotel Royal
The HOMELIKE Hotel of Philadelphia
at Broad St. & Girard Ave.
Philadelphia, Pa.

Combines every convenience and home comfort and—commends itself to people of refinement.

WITHIN 5 MINUTES OF CITY HALL

Rates as low as
\$1.50 \$2.00 \$2.50—Single
2.50 3.00 & up—Double

We make it our business to please
Ask for Mr. Smith, Mgr.

RADIO SERVICE MEN
Be sure to read the announcement on Page 692 of this issue which tells about the new ORSMA BULLETIN. It is the most up-to-the-minute news tabloid for all radio Service Men.

MERCURY-VAPOR TUBES

Since the type 82 tube has a 2½ V. filament, it is necessary to make some slight adjustment in the receiver as to voltage supply to rectifier tube; although, similar compensation may be applied externally by using an adapter. Since the type 80 tube has a 5 V. filament, it is necessary to drop this potential to the 2½ V. required for the 82 by connecting into the filament circuit a .75-ohm resistor with a rating of 10 to 15 watts.

Further information concerning the type 83 tube which employs a 5 V. filament, the same as the 80, is given by Mr. Walter R. Jones, writing in SYLVANIA NEWS, as follows:

With the new type 83 tube, much damage may be done by inserting the tube in the 80 socket without thinking. If this is done, providing nothing burns out in the receiver or "blows up," the receiver will give considerably better performance than it did in the past. This performance, however, is not likely to last long, since the increased voltage will sooner or later blow one or more of the filter condensers in a power unit. If this condenser simply opens up, a very loud and annoying hum will result. If, however, as is more than likely to occur, the condenser shorts, the power transformer in the receiver will be burned out unless the tube is instantly removed from the receiver. In addition to this, if anything should happen to the tube for even an instant it is quite likely that it would burn out the transformer before the tube could be removed. For this reason practically all receivers which are designed to employ the new mercury vapor rectifier tube are provided with a fuse, so that in the event of any momentary tube failure the fuse will be blown instead of ruining the power transformer.

In the past there has been some advertising which recommends the substitution of a mercury vapor rectifier tube for the type 80 tube which is now in the receiver. A safer way, if you are not satisfied with the performance of your present receiver, is to buy a new receiver which is equipped with the new and modern tubes rather than to attempt to change the receiver over to hap-hazardly use some of the new tubes. This sort of change is much like the change which often is made with the model T Ford of substituting a model A hood and expecting your car to run as a model A or a model B car does.

D. T. SIEGEL, General Manager of the Ohmite Manufacturing Company, announces that this company is now making two special values in the Red Devil line. These units have resistance values of .4-ohm and .83-ohm and are intended for use in replacing two type 81 tubes in a power pack with a single type 83 tube. These special value resistors are now carried in stock by many distributors.

The use of the 83 tube requires enough resistance to be inserted into the filament line to drop the voltage from 7.5 to 5.0 volts. On sets which have a single filament winding on the power transformer, the .83-ohm resistor is inserted in the filament line. For sets which have a center-tapped winding, it is better to use a .4-ohm resistor in each side of the filament line. This keeps the transformer in balance and prevents hum.

An R.F. choke must be connected in the negative or positive lead, with the 83 tube; this should be about 6 henries, 250 ohms, and able to pass 100-150 mls. (This "kink" was described by Jack Grand in the "Over-the-Counter" column of RADIO-CRAFT.—*Technical Editor*)

The main reason for using the 83 tube, aside from the more satisfactory operation, is the great saving in price. The list price of a pair of 81 tubes is \$10.50, while the list of the 83 is only \$1.55 which is a worthwhile saving. The cost of the resistors and chokes is very small compared to this saving.

RADIO CHASSIS—NEE MARQUETTE

Due to the confusion resulting from the use of the name "Marquette" which it appears had never been properly protected in so far as the Marquette Radio Company was concerned, they have changed their name to Radio Chassis, Inc. There have been no changes made in the corporate set-up whatsoever.

Build the NEW RADIOLAMP

The Finest A.C.-D.C. Radio Combined With a Practical Table Lamp—Ideal for Bedside, Table or Desk

This Universal Set can be used wherever there is 110-120 volt current, either A.C. or D.C. It employs the latest circuit, tubes and parts. The large lamp shade speaker gives full, rich tone quality, hitherto unobtainable in miniature receivers. All parts for building the RADIOLAMP are furnished in a complete KIT, with full instructions and simplified plans.



Servicement

As soon as your customers and friends see and hear your RADIOLAMP, they will want one just like it. Make money supplying this demand. The RADIOLAMP can be assembled and completed in a few hours and sells on sight for \$25.00. COMPLETE RADIOLAMP KIT—Containing all Parts Necessary to Build RADIOLAMP (less tubes). Full Instructions and Simplified Plans, only **\$13.75**

ESSENTIAL KIT—Containing Set of Find-All Coils, Drilled Lamp Base Chassis and Lamp Shade Speaker... \$5.75
Find-All Coils, Der set... \$1.50
Lamp Base Chassis... \$2.00
Lamp Shade Speaker... \$2.75
Full-Size Plans Free with Complete Kit—Otherwise... \$1.00

All Prices f.o.b. New York—All Parts Fully Guaranteed
Send Check or Money Order or Pay Postman Upon Delivery
THE RADIOLAMP COMPANY
Suite 541 98 Park Place New York, N. Y.

SERVICE MEN!



Send for our new 1933 Catalog... Just off the press. Everything in replacement parts. Tubes, Batteries, Latest Sound Systems, Automobile Sets and Electrical Supplies. 6000 different items at lowest wholesale prices. Prompt, reliable service. Send for this big FREE Catalogue today. You need it.

ALLIED RADIO CORP.

833 W. Jackson Blvd., Chicago, Ill.

Please send me FREE your new 1933 catalog.

Name

Address

City

State

FORDSON

announces a new and better midget radio AT THE LOWEST PRICES EVER QUOTED!

THE NEW SIX TUBE

Goldtone \$9.95

TRADE MARK

Superheterodyne

With automatic volume control

For six tube chassis and dynamic speaker

Mass production enables us to quote the lowest prices. Buy direct from manufacturer.

WE REFUSE TO BE UNDERSOLD!

FREE CIRCULAR GIVING COMPLETE INFORMATION

FORDSON RADIO MFG. CORP.

11700 Livernois Ave. Detroit, Mich.

AUDIO POWER TRANSFORMERS
OF EVERY DESCRIPTION
BUY DIRECT FROM THE MANUFACTURER AND SAVE BIG MONEY!
SET and AMPLIFIER MANUFACTURERS—DEALERS—SERVICE MEN—WRITE FOR OUR FREE CATALOG—Containing LOWEST PRICES QUOTED—Highest Type Distributors and Sales Representatives Should Contact Our SALES-DEPARTMENT.
MANUFACTURING DIVISION OF THE
REMINGTON-RADIO-ELECTRIC CORP.
121 R. WEST 17th ST. NEW YORK N. Y.

2

USEFUL RADIO BOOKS WHICH EVERY EXPERIMENTER NEEDS IN HIS LIBRARY

There is not a radio man in the field, experimenter, service man or dealer, who will not want to read these two books. Right up to the minute with outstanding developments in short-wave radio—new methods and apparatus for quickly learning how to become a practical radio operator. Each book is authoritative, completely illustrated and not too highly technical. The text is easily and quickly grasped.

How to Become an Amateur Radio Operator

We chose Lieut. Myron P. Eddy to write this book because his long years of experience in the amateur field have made him pre-eminent in this line. For many years he was instructor of radio telegraphy at the R.C.A. Institutes. He is a member of the I.R.E. (Institute of Radio Engineers), also the Veteran Wireless Operators' Association.

If you intend to become a licensed code operator, if you wish to take up phone work eventually, if you wish to prepare yourself for this important subject—this is the book you must get.

Partial List of Contents

Ways of learning the code. A system of sending and receiving with necessary drill words is supplied so that you may work with approved methods. Concise, authoritative definitions of radio terms, units and laws, brief descriptions of commonly used pieces of radio equipment. This chapter gives the working terminology of the radio operator. Graphic symbols are used to indicate the various parts of radio circuits. General radio theory particularly as it applies to the beginner. The electron theory is briefly given, then waves—their creation, propagation and reception. Fundamental laws of electric circuits, particularly those used in radio, are explained next and typical basic circuits are analyzed. Descriptions of modern receivers that are being used with success by amateurs. You are told how to build and operate these sets. Amateur transmitters. Diagrams with specifications are furnished so construction is made easy. Power equipment that may be used with transmitters and receivers, rectifiers, filters, batteries, etc. Regulations that apply to amateur operators; the International "Q" signals, etc.

How to Build and Operate Short Wave Receivers

is the best and most up-to-date book on the subject. It is edited and prepared by the editors of SHORT-WAVE CRAFT, and contains a wealth of material on the building and operation, not only of typical short-wave receivers, but short wave converters as well.

Dozens of short-wave sets are found in this book, which contains hundreds of illustrations; actual photographs of sets built, hook-ups and diagrams galore.

The book comes with a heavy colored cover, and is printed throughout on first-class paper. No expense has been spared to make this the outstanding volume of its kind. The book measures 7 1/2 x 10 inches.

This book is sold only at such a ridiculously low price because it is our aim to put this valuable work into the hands of every short-wave enthusiast.

We know that if you are at all interested in short waves you will not wish to do without this book. It is a most important and timely new radio publication.

Each Book Contains Over 150 Illustrations
72 Pages 7 x 10 Inches Not Sold on Newsstands

Mail Coupon at Left for Books!

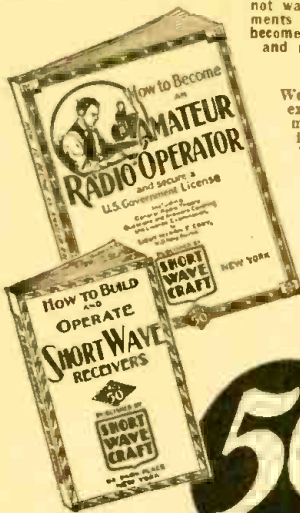

50¢
EACH

SHORT WAVE CRAFT
96-98 RC Park Place,
New York, N. Y.

Gentlemen: I enclose herewith \$..... for which please send me, prepaid a copy of the book checked.

() **HOW TO BUILD AND OPERATE SHORT-WAVE RECEIVERS—50c.**

() **HOW TO BECOME AN AMATEUR RADIO OPERATOR—50c.**

Send money order, check, cash or new U. S. stamps. Register letter if it contains stamps or currency.

Name

Address

City State

DID YOU SAY BARGAINS?
THAT'S WHAT I SAID BARGAINS!

Publisher's Samples and Bindery Rejects

We have on hand a few hundred copies of the **SECOND EDITION S. GERNSBACK RADIO ENCYCLOPEDIA**, which we are going to sell as quickly as possible at a marvelous bargain price.

We are going to call it a sale of "shop-worn" books. These books are actually, however—every one of them—new books, and for all practical purposes as good as any copy you could buy. They are copies that have been used by the publisher as display and salesman's samples, as in bookstore windows, exhibitions, etc. Some were set aside because of bindery imperfections, such as a slight defect in the gold-stamping, or a small irregularity in the texture of the cover—most of these blemishes being so slight as to be scarcely noticeable on ordinary inspection. The text dates are perfect. The books are not in any way marred, but merely not fresh enough to be sold as new books.

This Second Edition Radio Encyclopedia consists of 352 pages, weighs 3 lbs., bound in red Keratol flexible binder, size 9x12", contains 2,201 Radio Definitions; 1,253 tech. illustrations and 34 tables and charts.

We are disposing of these very fine books at the ridiculously low price of

\$2.00 per copy

New books of regular stock are selling currently at \$3.98. This offer of course will hold only so long as our special stock holds out—first come, first served!

We have also on hand a few hundred remaining copies of the unbound volumes of the **FIRST EDITION** of this encyclopedia, which we have been selling out very rapidly, at the close-out price of

69 cents a copy

The size of the book is 9 by 12 inches. It contains 168 pages, and is printed on the finest book paper obtainable, it contains over 1,930 definitions, 549 photo reproductions, drawings, and diagrams.

Don't send any money. Delivery will be made to you on the following plan:

ISKOR PRESS, Inc., 19 Park Place, New York, N. Y. RC

Please send me

SECOND EDITION, S. Gernsback Radio Encyclopedia, of your special "shop-worn" sale lot, at..... \$2.00

FIRST EDITION, S. Gernsback Radio Encyclopedia, of your unbound special lot,..... 69c

I will pay the postman the amount indicated above on delivery of my order, plus the small postage charge.

Name.....

Address.....

City..... State.....

SERVICE ELECTRIC Refrigerators!

In your community there are dozens of electric refrigerators to be serviced. Many need immediate repairs which can be made quickly, with little expense—and which you can repair with the aid of this authoritative Refrigeration Service Manual. Make many extra dollars, together with other repair work. Electric refrigeration servicing is a well-paying business—start in your spare time—before long you will devote full time to it. One or two jobs pays the small cost of the **OFFICIAL REFRIGERATION SERVICE MANUAL**.

96 Pages of New Data Have Been Added to the OFFICIAL REFRIGERATION SERVICE MANUAL

To bring this useful service manual right up-to-date, Mr. L. K. Wright, the editor of the **OFFICIAL REFRIGERATION SERVICE MANUAL**, has added a wealth of material on new electric refrigerators and older models as well. As usual every refrigerator has been accurately described from the viewpoint of servicing—diagrams to illustrate the essential parts, so simplified that repairs can easily be made. The inclusion of these new pages will not increase the cost of the book to those who order their copy now.

Here Are Some of The Important Chapters:

- Introduction to the Refrigeration Service Business
- History of Refrigeration
- Fundamentals of Refrigeration
- Description of All Known Types of Refrigeration
- Motors
- Trouble Shooting
- Unit Parts, Valves and Automatic Equipment
- Makes and Specifications of Units, Manufacturers of Cabinets, Refrigerants and Automatic Equipment and Many Other Important Chapters.

OVER 1,200 DIAGRAMS
450 Pages
Flexible Looseleaf Binder
Complete Service Data

Mail Coupon Today!

GERNSBACK PUBLICATIONS, Inc. RC-533
96-98 Park Place, New York, N. Y.
I enclose herewith my remittance for \$5.00 (check, stamps or Money Order accepted) for which you are to send me, postage prepaid, one copy of the **OFFICIAL REFRIGERATION SERVICE MANUAL**, together with the extra 96 pages of new material at no extra cost.

Name.....
Address.....
City..... State.....



WET OR DRY?*

The "wet" electrolytic has the ability to stand a tremendous amount of abuse in the form of overloading without excessive shortening of life and without much danger of permanent breakdown, due to the fact that such condensers, because of their construction, can dissipate a large amount of internally generated heat and are continuously self-healing as long as liquid remains within the unit. Fundamentally, such condensers have a somewhat higher power factor than the dry type of unit although it is possible to make even commercial wet electrolytic condensers with power factors as low as 10% at operating voltages of 400 and peak operating voltages as high as 500 may be obtained with the wet type of unit without inherently increasing the power factor beyond the safe maximum limit for this type of device.

Due to the mobility of any impurities which may remain within the wet condenser after fabrication, such units must be constructed with extreme care if good shelf life and good operating characteristics are desired and the worth of this type of condenser can be very largely determined by determining the history of the company making such a product and what their reputation is for care in this matter.

The wet condenser is very desirable for use as a first stage filter condenser, especially in units of high power output and where a high value of ripple is imposed on the condenser. Considerable use has also been made of the wet condenser, largely because of its ability to radiate a greater amount of heat without breakdown, as a voltage regulating device for the "B" supply in addition to its normal function of filtering. This action is of course a function of the leakage current of the condenser which increases rapidly above the so-called breakdown point. The breakdown potential of a wet electrolytic condenser, it might be mentioned, is a function of the solution and not primarily a function of the formation on the aluminum as is the case with the dry type of condenser. For this reason, the wet condenser does not re-form to a voltage higher than its normal breakdown voltage in use as is very apt to be the case of the dry type.

Recent refinements in the construction of wet electrolytic condensers have resulted in a unit which can be made to sell at a very low price that will stand a tremendous amount of abuse and that will show no evidence of the leakage of liquid that used to be so common among former devices of this type.

The "Dry" Condenser

The "dry" electrolytic condenser offers the advantages of extreme compactness, relatively low power factor, extremely low cost, and multi-unit construction within one container. It is but little affected by slight overloads as this type of condenser will form up to about 10% above its rated operating voltage and in some cases even more than this, where the overload is not too abrupt and where the mechanical structure of the condenser is such that this increase in voltage does not exceed the limits calculated to cause arcing within the device.

The dry type of condenser can be manufactured in such a way as to have very low impedance at relatively high frequencies and is therefore an excellent unit for bypass purposes. Such units are also made with both electrodes filmed over so that they may withstand A.C. without the application of any polarizing voltage and in the field of A.C. applications, especially at low and medium powers, the dry electrolytic condenser is making rapid strides.

Due to the possibility of winding multiple unit dry condensers in a continuous roll, forming several separate units either with or without a common cathode, or common anode section, or connection, within the condenser, the dry unit becomes a very versatile and flexible type of device as various multiple sections can be made by ingenious manipulation of the electrodes at a very low cost per unit for the completed condenser.

The dry electrolytic condenser is rather superior to the wet for use at low voltages and also has some advantage when used in locations where very low temperature ranges are experienced as for automobile radio receivers and the like.

*Courtesy, The Magnavox Co.

NEW ELECTRICAL AIDS TO NAVIGATION

How inaudible sounds are used to measure ocean depths while the steamer speeds on; how mariners locate their positions by radio waves; how light houses and harbor beacons are automatically turned on at nightfall; how ships may detect unseen icebergs in the dark through thick fog; and how the new automatic SOS receivers work, were recently described (and demonstrated) by Dr. Herbert Grove Dorsey, Principal Electrical Engineer, U. S. Coast & Geodetic Survey, who addressed the Science Forum of the New York Electrical Society.

The fathometer, for instance, he stated, is now used on hundreds of ships measuring fathoms whenever the captain wishes. In former days, he would have to slow up the ship, if the water were shallow, or stop if it were deep. But now he presses a button, the fathometer starts and after a few readings he assures himself that he has plenty of water. It is all finished in a few seconds, even though the depth be a thousand fathoms! By the method of lowering a wire to measure such a depth, the ship would have to be stopped at least a half hour, while now it can proceed at full speed, twenty to thirty knots, and in any kind of weather, day or night. With the fathometer right in the pilot house, the skipper has no anxiety about the depth.

With full details of the ocean bottom now given in our charts, navigators are finding them much more useful than just mere road maps of directions at sea. The bottom is seldom flat for any considerable area and, if a navigator is lost in a fog, he can keep his fathometer running a few minutes, mark the indications on a piece of thin paper, and by moving this around over the chart, keeping it parallel with his course, he will find some line on which his soundings will agree with those of the chart, locating not only his position and direction of travel, but giving also his speed. So vivid are the fathometer indications when steaming over rapidly changing depths that it is almost like seeing the bottom rise and fall, as do the hills and valleys by the road side as you ride along in an automobile.

Describing the Fathometer

In one part of the equipment, called the indicator, there is a small motor with a governor which, through a system of gears, rotates a black disc four times per second. Attached to the back side of the disc is a tiny neon tube, just a small edition of the same tube used in advertising signs and in television.

When this neon tube is illuminated its red light shines through a slot in the disc, but it is lighted only now and then. In front of the disc is a sheet of glass on which is painted a circular scale marked in fathoms from zero to 100. Every time the neon tube passes the zero point of the scale, an electric current passes through a sounder bolted to the bottom of the ship and a sound is produced as a short whistle blast. Only these sounds pass into the water; no wire is lowered, nothing is dropped, no connection with the bottom is made. The sounds themselves do the work by being reflected from the bottom of the ocean as echoes.

As the echoes return to the ship they are "heard" by a receiver of submarine sounds, or "electric ear" as it might be called, and an amplifier using thermionic tubes increases the loudness of the echoes so that the electrical energy will cause the tiny neon tube to make a single brilliant instantaneous red flash of light as the tube whirls around with the disc. This flash will shine through the glass, opposite some mark on the scale, six fathoms, for example, if that happens to be the depth of water through which the ship is passing. Four times a second the red light flashes at six fathoms, thus measuring a time interval of only fifteen thousandths of a second, and you read the depth as easily as you read time on a clock. Now, as the ship travels through deeper water, the red flashes will occur at later intervals, making the indications move along the scale to show increasing depths. In going from deep water to shallow, of course the red flashes will follow the scale backwards just as well as forwards. If the depth increases to more than a hundred fathoms a handle is turned shifting to a slower speed and another scale, so that, while the indications come less often, the depths can be

measured to 3,000 fathoms or more, nearly $3\frac{1}{2}$ miles of water!

Beacons and Electric Eyes

The Macneil "fog-eye," an infra-red instrument which enables the mariner to be warned of fog-obscured ice-bergs, ships, beacons, etc., even through dense fogs on dark nights, employs for its operation the infra-red waves or heat vibrations just beyond visibility. These infra-red rays, being longer than the light waves, come through and around the fog particles unimpeded. (The system was described in the May, 1931 issue of RADIO-CRAFT.—*Technical Editor*)

Radio beacons along our coasts enable mariners to locate their own positions by triangulating from unseen points on shore, greatly extending the influence of the ordinary lighthouse service.

Every ship which comes up New York Harbor after nightfall, steers its course by range lights which are turned on, each dusk, by electric eyes (photo-electric cells) and also extinguished automatically at daybreak.

(An interesting description of the "talking light beam" appeared in the April, 1933 issue of RADIO-CRAFT.—*Technical Editor*)

BOOK REVIEW

RADIO OPERATING QUESTIONS AND ANSWERS, by Arthur R. Nilson and J. L. Horning. Published by McGraw-Hill Book Co., Inc., New York, N. Y. Fourth Edition, $5\frac{1}{2} \times 8$ in., 350 pgs., 96 illustrations, cloth. Price \$2.50.

The Fourth Edition of this volume introduces a broader review of radio operation—broadcast, marine, aeronautical, police and amateur—as compared with previous editions which covered only commercial operating.

The volume includes over 600 typical questions, based on actual examinations, with full, illustrated answers. The knowledge contained in this volume makes the reader familiar with the essentials of all license tests, both commercial and amateur. For the technician who wishes to pass any type of radio license examination, or for the general experimenter desiring to increase his knowledge of radio facts, this volume is very valuable.

A NEW SERVICE

FOR ALL RADIO SERVICE MEN

Here is big news for every Radio Service Man. If you want diagrams of commercial radio receivers, we are now prepared to give you

RUSH SERVICE

In the three OFFICIAL RADIO SERVICE MANUALS published by us so far, we are listing almost 5,000 diagrams of commercial radio sets manufactured in America.

Heretofore, you could get these diagrams only by buying our OFFICIAL RADIO SERVICE MANUALS.

We have, however, had an increasing demand of late from Service Men who are not owners of any of the MANUALS but who wish to get one or more diagrams. We are now prepared to send you such diagrams on a rush order plan. We realize that if you want one of these diagrams you want it quick. For that reason, we now have a special staff to send any special diagram to you the same day that your order is received.

If you live a distance away from us, and cannot wait for the regular mail, send us 8 cents extra, and the diagram will be sent to you by Air Mail. These diagrams come to you on bond paper, size 9x12 inches. We are prepared to furnish practically any diagram you possibly can ask for—IMMEDIATELY.

HOW TO ORDER

Just tell us what diagram you want, giving us the name of the radio set and model number. It is absolutely necessary for us to have the model number, as without this there is no way of identifying the set. A mere description of the receiver or a list of the tubes it uses is of no help. We will immediately mail you the diagram, if it is available, the same day your order is received. Note: Question coupons are not acceptable for these diagrams.

WE HAVE A UNIFORM CHARGE FOR THIS SERVICE AND THAT IS 25c FOR EACH DIAGRAM

If you wish more than one diagram, the price is still 25c each, but if you order six at one time, the price will be \$1.00 for the six, providing all are ordered at one time.

GERNSBACK PUBLICATIONS, INC.

(Special Diagram Department)

96-98R PARK PLACE

NEW YORK, N. Y.

25c

A DIAGRAM

TOBE

CONDENSER PRODUCTS

are unexcelled for use in

Radio Servicing
Public Address Systems
Amateur or Broadcast
Transmitters

This complete line is now catalogued and stocked by

LEADING JOBBERS

Ask your jobber for a copy of his catalog including the complete TOBE Line, or write us for the name of the TOBE distributor nearest you.

Tobe Deutschmann Corp.
Canton, Mass.

RADIO OPERATING RADIO SERVICING



Prepare for the new Government Radio Operating license examinations; Radio Operator, Marine and Broadcasting. Also radio Amateur Telegraph and Telephone. Resident courses. Write for booklet.

"Opportunities in Radio"

WEST SIDE Y M C A TRADE & TECHNICAL SCHOOLS

7 West 63rd Street New York City

THE MULTITESTER—VOLT-OHMMETER-AMMETER

(Continued from page 664)

ohmmeters, and the owners must use another instrument for measuring current. The Multitester, however, is also a milliammeter, and has current ranges and scales of 0-5, 0-50, and 0-250 milliamperes.

There is no confusion about selecting the proper terminals, or tip jacks, for making measurements, as the one and only one set of terminal-voltage jacks is used for all scales. This pair of terminals is of the non-shorting type, and the positive is denoted by being colored red while the negative is colored black. Similarly, only one set of polarized jack terminals is used for all current measurements regardless of the scale selected. All ohmmeter measurements are available at the pair of non-shorting jack terminals marked OHMS.

A feature of the design is the single, simple selector switch which can be instantly set to use the instrument at any desired scale as either a voltmeter, ohmmeter, or milliammeter. An advantage of this design and switching arrangement is that the meter is automatically disconnected from all scales and circuits except the one in which it is definitely indicated by the position of the selector switch. There are many instances where instruments have been ruined due to a bit of carelessness combined with the fact that one side of the meter was also connected to some other circuit or battery.

When not being used as an ohmmeter, all battery terminals are entirely disconnected from the meter so that incorrect use of the terminals cannot cause damage by the self-contained battery. The zero adjuster used for setting the ohmmeter is a tapered winding to give smooth and gradual adjustments. It consists of a sectional rheostat with 15,600 and 6,000 ohms in each one-third of the winding space, respectively.

The knobs used to operate the zero adjuster and selector switch are of the large, low type, which provide a comfortable and firm grip. The white arrow pointer on the knob clearly indicates the operating position of the switch on the etched panel. The cir-

cuit is arranged so that less than 50 milliamperes is momentarily flowing when testing very low resistance values. For medium and high resistance values, less than one milliampere momentarily flows through the circuit. The batteries, which are self-contained, will, therefore, last practically their "shelf life."

The wiring diagram is shown in the figure. It will be seen that only 1.5 volts is applied for the 0-2,000-ohm scale, and 3 volts for the 0-200,000 ohm scale, while 30 volts is used for the 0-2,000,000-ohm range. The circuit is simple; but, when wiring, one must be sure to have all connections soldered to lugs on the various terminals.

Instructions

(1) Fasten the meter to the panel by means of the three mounting screws and nuts;

(2) Secure the zero adjuster rheostat to the panel by means of the locknut provided. Mount the knob on its shaft so that its pointer is at the left mark on the "low" position when the rheostat is turned to its extreme left;

(3) Fasten the selector switch to the panel by means of the locknut, and attach the knob so that the arrow points to the 2,000-ohm marking on the panel when the switch arms are in position No. 1;

(4) Insert the tip jacks and fasten them to the panel. Follow the diagram as to red and black color scheme. Be sure to use the insulated bushings when mounting the jacks;

(5) Mount the shunts and multipliers on the sub panel as shown. Wire the shunts to the meter and to the selector switch terminals of section No. 1 as per wiring diagram;

(6) Make the inter-connections between terminals of selector switch section No. 2 as shown in the wiring diagram. Connect terminal 9 of section No. 1 with terminal No. 1 of section No. 3 as shown;

(7) Wire the resistors having values of 25 ohms, 2,500 ohms, and 25,000 ohms as indicated. Connect the zero adjustment rheostat according to the diagram;

(8) Wire the voltmeter multipliers, following

the diagram. Connect all the tip jacks to the circuit as shown;

(9) Connect the battery terminals to the selector switch section No. 2. Be sure that all leads to the battery terminals are securely fastened and that there is no danger of a short circuit.

(10) Check the entire mounting and wiring very carefully. If everything is O.K., secure the panel in place by means of mounting screws. See that the pointer on the meter is in zero position. Adjustment may be made by means of a tiny screw driver to turn the small zero adjusting screw protruding through the meter glass.

The instrument is now ready for use. When used as an ohmmeter, turn the selector switch to the proper scale. Always short circuit the ohmmeter terminals (through the test leads) and turn the zero adjusting rheostat for full-scale deflection of the needle. This balances the ohmmeter calibration so the resistances may be accurately tested.

List of Parts

One Beede 0-1 ma. meter having scales of 0-2,000 ohms and 0-5-250-750 volts-ma.; One Supertest selector switch, 3 sections, 10 positions;

One Supertest tapered rheostat, 15-600-6,000 ohms.

Three Supertest shunts for 5 ma., 50 ma. and 250 ma. readings;

Four Supertest multipliers, 5,000 ohms, 50,000 ohms, 200,000 ohms, 500,000 ohms;

Three resistors, 25 ohms, 2,500 ohms, 25,000 ohms;

Two knobs;

Six Supertest insulated tip jacks, 3 red and 3 black;

One sub panel for mounting shunts and multipliers;

Two test prods and leads;

One 30-volt set of batteries.

One Supertest panel, drilled and etched, 5 1/2 x 8 1/2 inches;

One Supertest crystalline-finish metal case, 5 1/2 x 8 1/2 x 4 inches;

*Sensationally
New in Jig Saw Puzzles!*
*The Front Cover
of this Magazine in a 150 piece cut-out
A BEAUTIFUL 4-COLOR PUZZLE*

MAIL THIS
COUPON
TODAY WITH

25c

Radio-Craft Magazine
96-98, Park Place,
New York, N. Y.

Enclosed you will find my remittance for 25 cents (Stamps or money order accepted) for which please send me a Jig Saw Puzzle of the May cover of this magazine, in 150 pieces.

Name

Address

City State.....

JIG SAW PUZZLES will come and go—but here is one that's going to last a lifetime—It's none other than the cover of Radio-Craft, in four colors, and painted by Brown, the famous artist.

Here are many hours of fun for every member of the family—one, two or three hours of pleasant pastime, juggling and

turning each piece to complete this 150 piece puzzle.

Send for your Jig Saw Puzzle today—there's hundreds of hours of fun for only a quarter—just 25 cents in stamps or coin. The coupon below makes it convenient to order your puzzle. It also insures speedy delivery. Clip and mail today.

RADIO-CRAFT MAGAZINE

96-98 Park Place

New York, N. Y.

The latest addition
to the **RADIO-CRAFT**
Library Series—

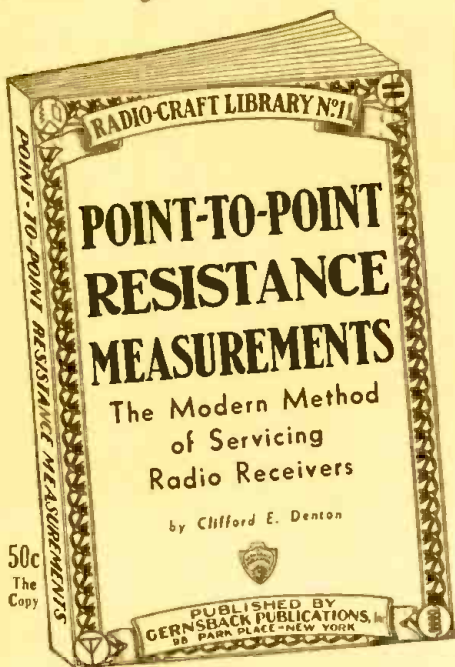

—ANOTHER VALUABLE BOOK FOR
SERVICE MEN

Of the difficult problems which Service Men face today when repairing receivers, the greatest is that of replacing proper resistance values in sets. This task becomes even more difficult when the values of resistors are unknown; and manufacturers of many standard sets do not pass this information on to Service Men.

In this new book, "RESISTANCE MEASUREMENTS," radio men will find the information needed to quickly place a receiver in normal operating condition. This book cuts in half, the time usually required to adjust the average set. Sufficient space has been devoted to the elementary problems and the theory of electricity as it is applied to resistance measurements so that the Service Man will have a comprehensive idea as to how to overcome this problem.

Below you will find a partial list of the contents which will appear in this new book... prepared by one of radio's foremost service writers, Clifford E. Denton.

Partial Contents of
POINT-TO-POINT RESISTANCE MEASUREMENTS

CHAPTER 1—INTRODUCTION. Advantages of Resistance Measurement Method of Servicing for Radio Work.

CHAPTER 2—Basic Principles.

CHAPTER 3—Methods of Resistance Measurement.

CHAPTER 4—Resistors in Radio Receivers and Amplifiers.

CHAPTER 5—Point to Point Resistance Measurements in Typical Radio Set using Ohmmeter.

CHAPTER 6—Resistance Measurements using Modern Tester.

CHAPTER 7—Routine Testing where Circuit Diagram is Available and where Resistances are Known.

CHAPTER 8—Routine Testing where Circuit Diagram is Not Available and where Resistances are Unknown.

CHAPTER 9—The Relation of Voltage Testing Methods to Resistance Measurement.

CHAPTER 10—APPENDIX. Resistance Charts, etc.

64 PAGES — 6x9 INCHES
OVER 100 ILLUSTRATIONS

Mail Coupon Today!

GERNSBACK PUBLICATIONS, Inc. RC-533
96-98 Park Place, New York, N. Y.

Enclosed you will find my remittance of Fifty Cents (check, stamps or money order accepted), for which you are to send me One Copy of POINT-TO-POINT RESISTANCE MEASUREMENTS, by Denton.

Name

Address

City

State

KEEP YOUR CUSTOMERS ADVISED OF GOOD PROGRAMS

Few Service Men follow the program weeklies very closely; yet, undeniably, one of the best ways of making customer-friends is to point out the better programs which may be regularly received. The following paragraphs, part of a talk delivered by James M. Skinner, president of Philco Radio & Television Corp., before a meeting of the Policyholder's Service Bureau of the Metropolitan Life Insurance Co., indicate the great lengths to which some organizations will go to meet the best interests of radio listeners. (Spot broadcasting, it will be recalled, has been described in RADIO-CRAFT as the method which uses special 33 1/3 r. p. m. electrically-recorded, long-playing program records in lieu of the actual orchestrations, etc.)

"* * * * We were able recently to organize in less than a week's time, a program of spot broadcasts using a hundred and twenty-three stations every night for five consecutive nights to promote a nationwide word building contest. Thus we used six hundred and fifteen broadcast periods in five days which the broadcasting companies tell us is a record.

"We always have used spot broadcasts, or at least our dealers have, with more or less constancy, but these again have been governed by the advice of our local agencies. During the past year, our principal broadcasting has been the concerts of the Philadelphia Orchestra under direction of Leopold Stokowski using all stations in a coast to coast system and supplementary short-wave transmission to carry these concerts to foreign countries.

"Our object in selecting Stokowski and the Philadelphia Orchestra was because we believed it advisable, almost our duty to broadcasting and to radio, to give the music loving radio owners of the world an opportunity to enjoy often, the world's finest music under direction of America's greatest musical director. These were not studio broadcasts but actual full length concert broadcasts direct from the Academy of Music while the distinguished and colorful audience was present.

"With these broadcasts, we held the air for an hour and three-quarters. (first) to avoid cutting the concerts to fit a predetermined program period; (second) to impress upon the public as well as upon other broadcasters, the quality of program that today's broadcasting and receiving facilities make possible; and (third) to prove our contention that it is not good business to originate too large a percentage of programs in the studios nor to have the listening hours cut up into so many short periods. We believe that a program must be of a quality to attract an audience and to hold an audience, and we think there should be enough of it to satisfy an audience. Only by these qualities do we believe that a program will impress its sponsorship enduringly upon a listening audience.

"We do not infer by this that all programs should run for an hour and three-quarters but we are mindful of the fact that vaudeville lost its hold on the public. We think the vaudeville rapidity of act presentation should be avoided in radio because listeners usually hope to settle down, relaxed, for a considerable period—perhaps an entire evening. When changes from one program to another are so frequent as to get the listener all jittery, radio, it seems to us, is being abused instead of used."

FOX HUNTING BY RADIO

That well-known columnist, "Ariel," writing in a past issue of POPULAR WIRELESS, laments as follows, anent the use of radio in pursuing Br'er Fox.

It is reported that in connection with a radio display at Pardubice, Czechoslovakia, wireless is to be used on aeroplanes to signal to valiant huntsmen in motor-cars the position of a fox, which will then be hunted by the aforesaid heroes till it is killed! I'm sorry! Radio has done so much that is useful and pleasant that to turn it to the purpose of assisting a small animal to be harried to death hurts my pride in the nobility of the human being. My full and uncensored opinion of fox-hunting by horse and hound alone would not be printed by any editor I have ever met or worked for. My opinion of a radio fox hunt would singe the very paper!



UNIVERSAL
Protected
Diaphragm Type
1933 Model "BB"

Damage proof diaphragm protection is now added to the superdependability of Model BB performance. Brand new ahead-of-the-times design. Double-weight, in-built ruggedness. The new 1933 Model BB offers a new conception of what microphone values can be. No advance in prices. Model BB still sells at \$25.00 list.

Universal Microphone Co., Ltd.
424 Warren Lane Inglewood, Calif., U. S. A.



SERVICE MEN Like These Handy VOLUME CONTROLS

Standard end covers and covers with power-switch assembly are instantly interchangeable. A great convenience and time-saver. Long, aluminum shafts, easily cut to desired length.

Write Dept. RC-5 for complete catalog
175 Varick St., New York, N.Y.

ELECTRAD
INC.



OUTSTANDING
for PROFITS and PERFORMANCE
Dealers and Service Men
MAKE BIG MONEY!

Quickly—wide-awake radio men can make good profits on a better grade of midjet radios. 4 and 5 tube midjets—of super construction—every set guaranteed. Excellent reception. Important details upon request.

4 tube, 2 circuit with tubes	\$11.00
5 tube, 3 circuit with tubes	13.00
5 tube, Super with tubes	15.50
5 tube, Short Wave Band Switching, 15 to 200 meters, (110 volt, AC-60 cycle)	20.00
5 tube Auto Radio and B Eliminator, complete	21.00

Regular 3 months guarantee. Write today.
TRUMAN RADIO COMPANY
7443-C Stewart Avenue, Chicago, Illinois

→ **Extra Special** ←

SAMSON AUDIO AND POWER SUPPLY COMPONENTS
At Considerable Price Reductions
A FEW EXAMPLES LISTED HERE

Cat. No.	Title	List Price	Our Price
S	Symphonic Audio Transformer	\$10.00	\$1.69ea.
Y	Input or Interstage Push Pull A.F.	14.00	1.95ea.
O4-O7-O8	Output Transformers	10.00	1.45ea.
M.L.	Mike to Line Transformer	30.00	2.95
TL	Tube to Line	30.00	2.95
LT	Line to Tube	30.00	2.95
R.F. Choke 85, M.H.		2.50	.69
Phono and Radio Scratch Filter		2.50	.69

ALMOST ALL SAMSON NUMBERS IN STOCK
Write for information on any Samson products not listed here
ALAN RADIO CORP.
83 R. Cortlandt St. New York, N. Y.

PATENTS TRADE MARKS
COPYRIGHTS

"Little Ideas May Have Big Commercial Possibilities"
PROTECT THEM BY PATENTS

Send for our Free book, "How to Obtain a Patent" and "Record of Invention" blank—Deferred Payments Prompt Service—Reasonable Charges—Deferred Payments
HIGHEST REFERENCES

VICTOR J. EVANS & CO.
Registered Patent Attorneys—Established 1898
650 E. VICTOR BUILDING WASHINGTON, D. C.

EASY WAY TO
MAKE MONEY IN RADIO

New training method and service equipment offer starts you earning quickly. Covers all the latest developments in radio science, preparing you quickly and thoroughly for good positions or independent business career. Send NOW for all particulars to

Radio Training Association of America
Dept. RCA-5, 4513 Ravenswood Ave., Chicago, Ill.

The Radio-Craft Library Series is handy for reference!

Presented on this page are the new books of the RADIO-CRAFT LIBRARY—the most complete and authentic set of volumes treating individually, important divisions of radio. Each book has been designed to give radio men the opportunity to specialize in one or more of the popular branches of the industry. The material con-

tained in these books will increase your knowledge; you will find them a real help in your work and they will contribute to your money earning capacity. Read these books during your spare time at home.

The authors of these books are well-known to everybody. Each one is an expert radio man; an authority on the

subject—each is thoroughly familiar with the field which he represents.

This is perhaps the first real opportunity that you have ever had to build a radio library of books that are authentic, right-up-to-the-minute and written so that they are easily digested and clearly understood. Mail coupon below for your books.

**TO THE RIGHT
WILL BE FOUND
A SHORT RESUMÉ
OF EACH BOOK**

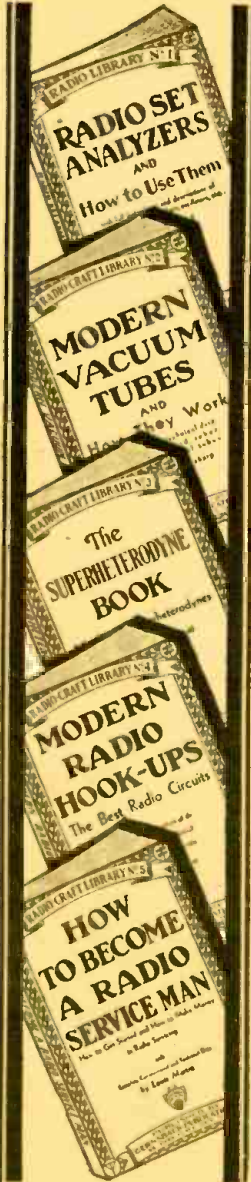

Book No. 1
RADIO SET ANALYZERS
And How To Use Them
With Full Instructions and Descriptions of Set Analyzers, Tube Checkers, Oscillators, Etc.
By L. VAN DER MEL

This book explains thoroughly the operation of set analyzers, tube checkers, oscillators and other testing equipment. For every radio man this book is extremely helpful. It covers every phase of testing and gives you valuable short cuts; completely illustrated with photographs and diagrams to facilitate the use of modern testers.

Book No. 2
MODERN VACUUM TUBES
And How They Work
With complete Technical Data on All Standard and Many Special Tubes
By ROBERT HERTZBERG

MODERN VACUUM TUBES describes the fundamental electron theory which is the basis of all vacuum tube operation, and goes progressively from the simplest two-element tubes right up to the latest pentodes and thyatrons. It is written in clear, simple language and is devoid of the mathematics which is usually so confusing. Valuable reference charts and characteristic curves of standard and special tubes are to be found, also diagrams of sockets and pin connections.

Book No. 3
THE SUPERHETERODYNE BOOK
All About Superheterodynes
How They Work, How to Build and How to Service Them
By CLYDE FITCH

There is no more fascinating a subject in the large array of radio circuits than the famous superheterodyne circuit. Whether you are a Service Man or experimenter, first-hand knowledge about the construction of superheterodyne receivers is very important. The book on Superheterodynes gives underlying principles of their construction, right from the very first set made.

Book No. 4
MODERN RADIO HOOK-UPS
The Best Radio Circuits
A Complete Compendium of the Most Important Experimental and Custombuilt Receivers
By R. D. WASHBURNE

It is fascinating to the experimenter, or even to the up-to-date Service Man, to take a commercial set and to change it into one using a famous hookup that is not found in any manufactured set. Many excellent circuits have never been commercialized, but limited only to home set builders. Thousands of these popular circuits have been requested from time to time, and in this book we have included over 150 circuits, which include the famous Peridyno, Cash-Box A.C.-D.C. Set and others.

Book No. 5
HOW TO BECOME A RADIO SERVICE MAN
How to Get Started and How to Make Money in Radio Servicing
By LOUIS MARTIN

The ambition of many men in radio today is to become a first-grade Service Man. It is not as difficult as one might believe, but it cannot be done in a few short months. Following very carefully the advice of Mr. Martin, who has dealt with the problems of thousands of Service Men, this book deals very carefully with the essential stages in the preparation for qualifying as a Service Man.

Book No. 6
BRINGING ELECTRIC SETS UP TO DATE
With Pentodes, Multi-Mus, Dynamic Speakers—Complete Information How to Modernize A. C., D. C. and Battery Operated Receivers
By CLIFFORD E. DENTON

In this country there are over ten million electrically operated receivers that could be modernized—by placing in them new type tubes, new speaker equipment and other modern improvements. This business of improving old sets can go to the experimenter and Service Men if they will quickly jump into action.

Read in this book by Mr. Denton, how easily you can modernize any obsolete set, and with little additional cost.

Book No. 7
RADIO KINKS AND WRINKLES
For Service Men and Experimenters
A Complete Compendium on the Latest Radio Short-Cuts and Money-Savers
By C. W. PALMER

If often becomes necessary for experimenters and Service Men to call upon their memory for some short cut or radio wrinkle that will solve a problem quickly. In business, "short cuts" mean time and money saved, and to the Service Man "time saved" means money earned.

This book is a compilation of important radio kinks and wrinkles and discusses only such items as are constantly used today.

Book No. 8
RADIO QUESTIONS AND ANSWERS
A Selection of the Most Important of 5,000 Questions Submitted by Radio Men During the Course of One Year
By R. D. WASHBURNE

There have been collected a wide variety of questions which have come into our editorial offices during the past two years, and only those whose answers would benefit the majority of men engaged in radio have been incorporated in this amazing question and answer book. A tremendously long list of topics is treated.

Book No. 9
AUTOMOBILE RADIO AND SERVICING
A Complete Treatise on the Subject Covering All Phases from Installing to Servicing and Maintenance
By LOUIS MARTIN

Automobile radios are up and coming, and someone has to service them properly. It therefore behooves you to read this immensely important new book on the art of Automobile Radio. The book is concise, and full of illustrations, photographs, diagrams and hookups.

A few of the really interesting chapters: Introduction; Automotive Radio Installations; Complete Descriptions of Commercial Automotive Receivers; Servicing Automotive Receivers; The Ignition System; General Service Considerations; Effects of Temperature on Power Supply; Conclusion.

Book No. 10
HOME RECORDING AND ALL ABOUT IT
A Complete Treatise on Instantaneous Recordings, Microphones, Recorders, Amplifiers, Commercial Machines, Servicing, etc.
By GEORGE J. SALIBA

If there is one subject that is fascinating to every radio man, it is that of Home Recording. Of course, this volume is not all on "Home" recording, but the information contained therein is important to commercial radio men, studio operators, engineers and others interested in this phase of radio.

The art of recording and producing broadcast selections is becoming more important every day to radio men, experimenters and Service Men. Equipping dance halls, auditoriums, churches, restaurants and homes with public address systems and amplifiers brings many extra dollars and often an excellent income.

BIG DISCOUNT OFFERED

In order to make it possible for everyone to buy these books, the fifty (50) cent price has been made uniform for all volumes. You can buy these books separately, but you should take advantage of our special offer:

When Five (5) Books or More Are Ordered
Deduct 20%
from Your Remittance

Simply fill in the coupon below, and mail it to us together with your remittance. Checks, stamps or money orders accepted.

ALL BOOKS UNIFORM

The books in the new RADIO-CRAFT LIBRARY are all strictly up-to-date, and written by men who know their subjects. The volumes are all uniform size, 6x9 inches, and contain on an average of 50 to 120 illustrations. Each book is printed on fine book paper, and no expense has been spared to make it an outstanding value. For its editorial contents as well as for the mechanical standpoint.

Clip Coupon and Mail Today!

GERNSBACK PUBLICATIONS, INC., 96-98 Park Place, New York, N. Y.

I have circled below the numbers of books in the RADIO-CRAFT LIBRARY, which you are to send me, and have deducted 20% for ordering five (5) books or more. I have included my remittance in full, at the price of 50c each, when less than five books are ordered.

The amount of my remittance is _____ (Stamps, checks or money orders accepted.)

Circle numbers wanted: 1 2 3 4 5 6 7 8 9 10

Name _____ Address _____

City _____ State _____ RC-5-33



RCA
Westinghouse
Victor

TWO STAGE 250 SUPER-POWER AUDITORIUM-SOUND TRUCK and PUBLIC-ADDRESS-AMPLIFIERS

\$8.95
TUBES REQUIRED
1-226, 1-250,
2-281.

FACTORY WIRED
READY FOR
IMMEDIATE
USE



Excellent
Adapted for
RADIO TUNER
PHONO PICKUP
MICROPHONE
AMPLIFICATION

BRAND
NEW!

FULLY GUARANTEED!

This Amplifier is the original AP-736 Model (which was furnished with Victor Electrodes selling as high as \$1,000.00!). Due to the "quick heater" action of the 1st A.F. Tube, and in fact of all the tubes in the \$8.95 Model, that amplifier is especially valuable for use in INTER-OFFICE COMMUNICATION SYSTEMS, or wherever it is necessary to operate an amplifier "the moment" it is turned on! The two stage \$8.95 model employs 1-226 input tube (and associated high and low impedance input transformers), which is audio transformer coupled into a 250 stage and utilizes FULL WAVE 2-281 Rectifiers. An output transformer furnished matches an 8 to 15 ohms voice coil of any dynamic speaker. The three stage highly improved \$19.50 model comprises the following: A UNIVERSAL INPUT VOLUME CONTROL is in the grid circuit of the first "pre-amplifier" 56 tube, the output of which is resistance coupled into a second 56 A.F. Stage, which in turn is PUSH-PULL TRANSFORMER COUPLED TO TWO SUPER-POWER 250 TUBES! Its enormous output of 13 watts is DISTORTION-FREE and amazingly faithful in its sheer realism of fidelity. By virtue of its employment of THREE HIGH GAIN A.F. STAGES, microphone and phono pick-up amplification is enormous and makes this amplifier accordingly extremely valuable. (Its D.B. Gain is rated at 92 D.B.) The input terminals may be connected to any secondary winding of any input transformer (generally contained in control boards) or to a radio tuner output plate circuit, high impedance phono pick-up, etc. Both the \$8.95 and \$19.50 models furnish D.C. Field Current Excitation to from One to Four Dynamic Speakers. Connection diagrams are furnished showing how to connect the field coils of 1-2500 ohm, 1 or

2-1000 ohm, or 4-2500 ohm (110 Volt D.C. Type) DYNAMIC SPEAKERS. Note that if only one Speaker will be used, then no output transformer is required, as our Speakers are equipped with a suitable matching transformer. Constructed upon a 1/2 in. thick malleable iron chassis of great strength, handsomely duco sprayed, measuring 17 1/2 in. long 12 1/2 in. wide and 7 1/2 in. tall over-all. An imposing idea of its contents can be gleaned by its weight of fully 68 lbs. The power transformer is of heavy-duty design, and will function practically indefinitely, even over continuous operating periods. The filter condenser system is also practically foolproof. Due to some of its units being rated as high as 1,500 volts! Perfect impregnation of vital components makes same impervious to the ravages of both extremes of climatic changes... even ideal for use in the tropics! A clever automatic and fool-proof switching arrangement protects the amplifier should it be turned on when a speaker is temporarily disconnected. Another switch permits selection of 90 to 105 Volt or, 105 to 120 Volt A.C. operation. Receptacles are provided for an A.C. Line Cord Male Plug and for a convenient speaker field current outlet. All connection terminals are clearly engraved on a readily accessible bakelite terminal strip. PRODUCES GIGANTIC DISTORTION-FREE VOLUME. REMARKABLE LIFE-LIKE REPRODUCTION! You will be immensely thrilled by the almost uncanny reproducing qualities of these amazingly powerful amplifiers—either using it as a microphone, phonograph or Radio Tuner amplifier! We want you to expect the most, for, you will not be disappointed!

TWO STAGE SUPER-POWER 250 MODEL

TWO STAGE AMPLIFIER Less Tubes and Speaker Ready For Immediate Operation **\$8.95**

TWO STAGE AMPLIFIER With Four RCA Tubes and choice of one Wright De Coster or Jensen Dynamic Speaker **\$17.50**

TWO STAGE AMPLIFIER Equipped With FOUR GENUINE RCA TUBES (1-226, 1-250, 2-281) **\$12.75**

TWO STAGE AMPLIFIER With Four RCA Tubes and choice of two Wright De Coster or Jensen Dynamic Speakers **\$22.50**

Three Stage 250 Push-Pull 13 Watt Model

3 STAGE AMPLIFIER Less Tubes and Speaker Ready For Immediate Operation **\$19.50**

3 STAGE AMPLIFIER, with GENUINE RCA tubes, and including your choice of one Wright De Coster or Jensen Dynamic Speaker... **\$33.50**

3 STAGE AMPLIFIER Equipped With SIX GENUINE RCA TUBES (2-56, 2-250, 2-281) **\$26.50**

3 STAGE AMPLIFIER, with six Genuine RCA tubes and including your choice of TWO Wright De Coster or Jensen Dynamic Speakers... **\$38.50**

Special Output Transformer—Matches voice coils of from 2 to 16 Dynamic Speakers. Rating: 500 ohms, 15-7 1/2-3 1/4 ohms, \$3.95

Auditorium or Sound Truck RCA Amplifier



Complete As Illustrated **\$89.50**

Rightfully Considered the Biggest Value in America Today! Careful selection of accessory equipment to comprise a perfectly matched P.A. System was the dominant

13 Watt Output Complete P.A. Installation

thought of our P.A. Engineering Dept. You may purchase this complete system with every assurance of obtaining maximum sound coverage and perfection of reproduction. Each speaker field is energized from the amplifier and a SUITABLE OUTPUT VOICE COIL MATCHING TRANSFORMER is furnished as well. Note that the "ALL PURPOSE PHONO-MIKE-RADIO" Input Control Box permits perfect blending, fading and super-imposition of voice across a phono, record, etc., etc. It also permits the separate placement of the amplifier proper from this very efficient input control box. (If only two Dynamic Speakers are desired, deduct \$10.00 from the cost price shown to the right.)

Complete Installation Consists of:

- 1 Three-Stage RCA Amplifier... \$26.50
- 1 Set of Six Genuine RCA Tubes... 4250 ohm D.C. Jensen or Wright De Coster Dynamic Speakers, at \$7.35... 29.40
- 1 SPECIAL OUTPUT TRANSFORMER... 3.95
- 1 P.A. Double Button Microphone... 12.50
- 1 45 to 72 In. Adjustable "Mike" Stand and Ring... 7.95
- 1 "All-Purpose" Input Control Box... 17.50
- 1 33 1/2 and 78 R.P.M. Dual Speed 110 volt A.C. Phono Motor... 9.75
- 1 Dual Speed Phono Pick-up... 6.75

Special In-ducement **\$89.50** Total \$114.30

One-Dollar-Series

Service men and Set Builders: Employ These High Grade Transformers Exclusively! These transformers are all designed on a 3/4 in. square core of high Silicon steel. The core is securely held in a rigid steel channel strop. Designed in accordance with the latest technique; they can be depended upon to give very satisfactory results! The 6 inch leads are made of heavily insulated wire and bear the R. M. A. standard color coding. The coils are scientifically treated to be impervious to all atmospheres—a very valuable and necessary feature. The overall measurements of all the transformers are 3 1/2 in. long, 2 in. wide, 2 in. tall. There is no better quality transformer available!

Westinghouse Audio Transformers

Audio and Input Push-Pull Transformers
5 to 1 Audio 3 to 1 Audio
2 to 1 Audio
Input Push-Pull
Input Push-Pull with Split Secondary
Inter-Stage Push-Pull
Microphone Inputs
Single Button—200 ohm
Double Button—200 ohm
Line Transformers
500 ohm line to Grid
Plate to 500 ohm Line
Control Box to 500 ohm Line

Output Transformers
From 1-171, 245, 250, etc. to 8-15 ohms Voice Coil
From 1-247, 59, 233, 238, etc., to 8-15 ohms Voice Coil
From 2-171, 245, 250, etc., to 8-15 ohms Voice Coil
From 2-247, 59, 233, 238, etc., to 8-15 ohms Voice Coil

Phono-Pickup Inputs
Low Impedance
High Impedance
Filter Choke
30 Henry, 200 ohms, 150 mil

YOUR CHOICE
\$1.00
Each

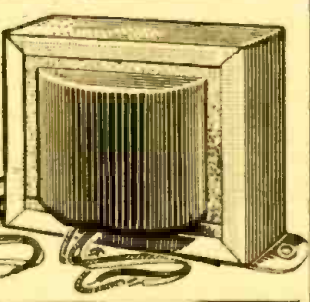

All offers are F. O. B. New York, and subject to prior sale. Terms: A deposit of 20% is required with every order. Balance may be paid on delivery. Or, deduct 2% if full amount is sent with order.

GRENPARK CO., Dept. RC 245 GREENWICH STREET, NEW YORK, N. Y.

Make Try-Mo Your Short-Wave Headquarters

For Many Years Try-Mo Has Been The "Ham's" Headquarters For Short-Wave Receiving and Transmitting Apparatus.

POWERTONE

SHORT WAVE

WORLD RECEPTION

A.C. AND D.C. RECEIVERS

Try-Mo's adequate staff of Short - Wave Experts are always at your service to assist you in your problems on receiving and transmitting.

Years of diligent experiments in the POWERTONE "LABS" have finally produced SHORT-WAVE RECEIVERS that have earned a TRULY ENVIABLE REPUTATION in their RECEPTIVE QUALITY—CAREFUL CONSTRUCTION—BEAUTIFUL APPEARANCE—and UNSURPASSABLE QUALITY PARTS.

POWERTONE has been made a WORLD-FAMOUS NAME by their production of ONLY QUALITY EQUIPMENT. You can have the UTMOST FAITH in a GUARANTEED POWERTONE SHORT-WAVE RECEIVER.

All sets complete with 6 mos. guaranteed SYLVANIA Tubes.

2-Tube Battery Operated

A "peach" of a set for the "Beginner." Experience the thrill of Real Short-Wave Reception—Police Signal! Amateurs! Ship-To-Shore Signal! C. W. I. Uses sensitive 232 screen grid and 233 powerpentode output two-volt tubes.

Wired, with tubes (less batteries) **\$9.95**
 Kit of Parts with tubes (less batteries) **7.95**
 Complete set of batteries **2.75**

3-Tube Battery Operated

Uses the new 234 R.F. pentode tube which is noted for its sensitivity in picking up weak signals. Two 230's follow the pentode, one a detector and the other used as an audio.

Wired, with tubes (less batteries) **\$12.95**
 Kit of Parts with tubes (less batteries) **10.75**
 Complete set of batteries **2.75**

3-Tube A. C.

Uses the latest '56 general purpose triode and a '57 triple grid amplifier tube. Quiet, humless short-wave reception. An '80 type tube is used for rectification. Hinged top on cabinet facilitates removal of coils and tubes.

Wired, with tubes **\$14.95**
 Kit of Parts, with tubes **12.75**

Powertone A. C. sets have a special filtering system which reduces hum to a minimum thus affording the listener clear, loud humless reception.

All sets listed are complete with four coils covering wave lengths from 15 to 200 meters.



4-Tube A. C.

Utilizes one '56 triode tube, a '58 triple grid R.F. amplifier tube, a '47 pentode power amplifier tube, and an '80 type rectifier tube. Uses OCTO form coils that covers wave length from 15 to 200 meters. Cabinet with hinged top for easy removal of coils.

Wired, with tubes **\$19.75**
 Kit of Parts, with tubes **16.95**

5-Tube A. C.

The Paramount of Powertone Receivers. With this masterpiece of engineering you can reach out to the distant corners of the earth for new and different thrills. Uses two 258 triple grid amplifier tubes, one '56 triode, one '59 triple grid power amplifier tube, and one '80 type rectifier.

Wired, with tubes & OCTO form coils **\$24.95**

ALL SETS COMPLETE WITH TUBES

R. C. A. Magnetic Speaker Chassis



The identical chassis used in the 100A, 100B and 103 R. C. A. speakers. Built-in output transformer permits use of former volts without distortion or rattling. The armature, which is accurately centered, and the sturdy metal frame which is lined with special self-healing fabric greatly improve acoustic properties of this speaker chassis. 9" outside diameter.

\$2.95

Price.....

New 1933 "ROCKET" 2-Tube Short Wave

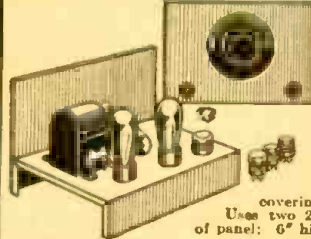

In the design of the "ROCKET" results were the keyword, and at the same time, highest quality parts at the lowest prices were kept in mind. Clear blueprints, showing the construction of the "ROCKET," are furnished with all kits. The kit contains every conceivable part necessary for assembling a complete Short-Wave Receiver:—including HAMMARLUND Tuning Condenser; drilled and punched metal panel which eliminates hand capacity; drilled base for mounting of sockets, etc.; Four plug-in coils covering wave lengths from 15 to 200 meters. Dimensions of panel: 6" high, 9" wide.

Uses two 230 type two-volt tubes.

Complete kit of parts, with blueprint..... **\$4.25**
 Set of two 230 Sylvania tubes..... **1.50**
 Set of batteries (Includes two "B" batteries, two dry cells)..... **2.25**
 Lightweight Headphones..... **95c**
 Completely wired..... **5.50**

FARRAND (Permanent Magnet) Inductor Dynamic Chassis

GUARANTEED FARRAND Inductor Dynamics, and not the "Booster" type now flooding the market. No field excitation required because of the two oversized permanent magnets which supply the fixed magnetic field. Its amazing fidelity of reproduction throughout the entire musical range, will register from low bass to the highest treble. One of the highest recent types developed. High or low impedance output tubes. Please specify type of power tube.



12" model..... **\$4.95**
 9" model..... **5.95**

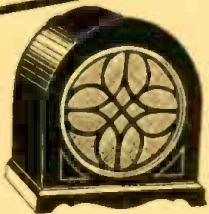

BOSCH Speaker Cabinet

A beautiful walnut cabinet that is attractively finished and hand-rubbed to a soft, satiny sheen. Will accommodate any speaker up to and including 10" in diameter. Will materially enhance any surrounding in which it is placed.

Price..... **\$1.95**

Jensen D-7 A.C. Dynamic Speaker



Designed for all types of amplifier systems, and particularly for use with late model receivers requiring an A. C. Dynamic speaker. Comes in 10 3/4" diameter—overall height 13". An 8 mfd. electrolytic condenser is used to minimize any A. C. hum.

Price (with tube)..... **\$8.95**

"Beginner's Twin" Short Wave Receiver

(Battery Operated)

As described in the New York Sun, March 4th, 1933. Designed by a famous radio engineer. Not a makeshift affair, but a carefully built kit that really brings in Short Wave Stations. Extreme simplicity of the circuit is the major factor of the "Beginner's Twin," thus eliminating any complications in the hookup.

Recommended for those people who are interested in experimenting on short-waves, but who do not wish to spend too much money. This kit is not only very low in price, but of such simple construction that it requires no practical knowledge of radio to assemble it. Now everyone interested in the new "short-wave" can afford to try his hand at building a receiver of his own that will receive short wave stations. The kit is comprised of nationally-known, standard parts.

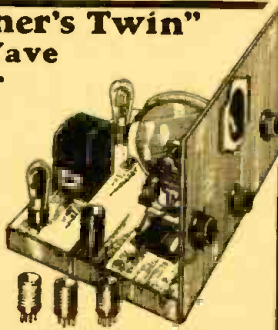

Kit of parts with blueprint and tubes..... **\$7.95**
 Wired with Sylvania tubes..... **8.95**
 Complete set of batteries..... **2.50**

NOW! Stromberg-Carlson MAGNETIC PICK-UP OUTFIT



A genuine Stromberg-Carlson Phonograph Outfit in original cartons, selling now for only.....

\$5.50

It seems incredible, yet figures don't lie. A \$30 list outfit which we have always sold for \$7.95, offered for a limited time for \$5.50. Thousands have been sold at the former price and acclaimed by all as a superb value. Can you imagine the value you are getting with the price practically at cost.

Look what you get!
 Stromberg-Carlson Pick-Up with Built-In Volume Control
 Stromberg-Carlson Input Transformer
 20 Ft. Insulated Extension Cord
 New, Improved Pick-Up Plug

TRY-MO RADIO CO. INC. 85 Cortlandt St. New York

20% deposit must accompany all C. O. D. orders.

178 Greenwich St., N. Y. C.
 Near Dey St.

BRANCH STORES

179 Greenwich St., N. Y. C.
 Near Cortlandt St.

Note: Send Mail Orders to Dept. C5, 85 Cortlandt St., New York City.

Send for Our New Bargain Catalog replete with Radio Parts.

New Powertone "Pal" A. C. Dynamic Speaker

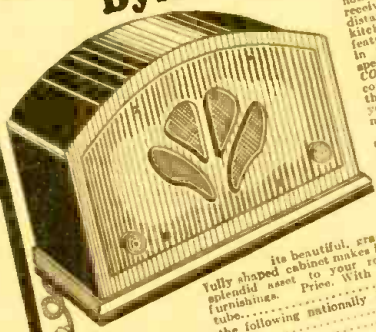

Now you can hear your favorite radio programs in any part of the home without having to sit near the receiver. If you happen to be in some distant part of the home—bedroom, kitchen, cellar, etc.—the new 1933 Powertone "Pal" speaker has utilized a feature which sets it apart from other speakers, which enable you to control the volume without going to the receiver. An on-off switch allows you to disconnect the speaker when not in use.

The extremely low price of this speaker will no doubt influence you to install one in those rooms where you are desirous of listening to the high quality music which this speaker furnishes. Its small compact size—7 in. high, 10 1/2 in. wide and 6 in. deep, does not require any spacious corner, and

its beautiful, gracefully shaped cabinet makes it a splendid asset to your room furnishings. Price, With 250 tube.....
 The same cabinet with the following nationally known speakers:
 With B.B.L. Magnesia Speaker.....

\$6.25
\$6.50
\$4.50

POWERTONE Modulated Oscillator



Provides 100% modulated signal at all frequencies in the broadcast band, and all those frequencies commercially employed in the intermediate amplifiers of super-heterodynes. The tenth harmonic is used for broadcast receiver testing, and readings are obtained directly from a calibrated scale reading from 55 to 155 k.c. by simply annexing a cipher mentally to the dial reading. The calibration is accurate within 3% at all settings and to 2% over the greater portion of the range. Using a single tube the strength of oscillation is sufficient to produce a signal by radiation arrangements. The immediate frequencies calibrated are: 115, 130, 172.5, 177.5, 200, 400, and 450 k.c.—all commercially employed frequencies. A.C. Model.

\$6.93
 76c
\$6.53

Battery operated (using 230 tube, using two dry cells and 2 3/4 volt battery).....
 (less batteries and tube)

KELLOGG SINGLE BUTTON HAND "MIKE"



(Not a toy microphone)
 A high grade single button microphone made by one of the largest manufacturers of microphones. Can be used on portable public address systems, by amateurs, and can be connected to any radio receiver. PRICE.....**\$1.45**

Prime A. C. Phonograph Motor



A sturdy, powerful, compact heavy duty motor of the self-starting induction type. Will not set up disturbing noises in any receiver. Equipped with bearing surfaces to provide adequate support and to insure long life. Quick starting. Full speed is attained immediately. Comes with mounting plate to ease mounting, and speed control. PRICE.....**\$5.50**

POWER .00035 Variable Condensers

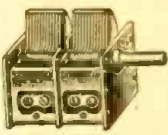

A two SHUNT CONDENSER with trimmer and self adjusting bearings to provide smooth and easy rotation. Heavy aluminum plates. Steel, cadmium plated shaft and frame. Shaft is 3/8 inch. Dimensions: 2 1/4 x 2 3/4 x 1 7/8". Especially adaptable for use in the new A.C. and D.C. universal receivers. (with pair coils) PRICE.....**\$1.75**

NEW BEEDE METERS D'Arsonval Movement

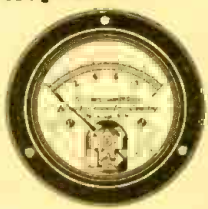

Beede moving coil instruments are available at prices which are amazingly low for this type of instrument. Unusually ruggedness, high accuracy, and freedom from dust and foreign matter. Perfectly balanced in all positions. And the moving system is exceptionally well damped. Accuracy guaranteed within 2%.

Range	Price	Range	Price
0-1.....	\$4.12	0-30.....	\$3.25
0-1.5.....	4.12	0-50.....	3.25
0-2.....	4.12	0-100.....	3.25
0-3.....	4.12	0-150.....	3.25
0-5.....	3.25	0-200.....	3.25
0-10.....	3.25	0-250.....	3.25
0-15.....	3.25	0-300.....	3.25
0-20.....	3.25	0-500.....	3.25
0-25.....	3.25	0-800.....	3.25
0-1000.....	\$3.25		

FLECTHEIM 0-500 Voltmeter

Resistance 200 ohms per volt. Uses only 5 mls. Portable type. Reads from 0-500 volts D.C. Highly nickel plated finish. Heavy insulated leads. PRICE.....**\$1.35**



Powertone Microphone Input Stage

Made for single or double button microphones. Will match any two button "mike" to the grid and filament of any tube or to any phonograph jack or amplifier. Uses one standard No. 8 Dry cell. The secondary of transformer is shunted by volume control. A battery switch is used for "on" and "off" control. PRICE.....**\$3.50**

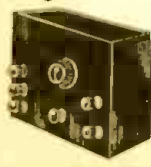

SINGLE BUTTON.....**\$3.50**
 DOUBLE BUTTON.....**\$4.95**

Powertest 3 Gang Condensers .00035

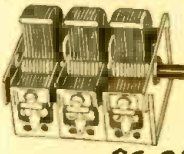

A three gang condenser which can be used for super heterodyne circuits. One section of condenser is provided with slotted plates for oscillator tracking. Each section is provided with separate trimmers. PRICE.....**\$1.25**

Powertest .00014 Condenser



A single gang condenser with .00014 capacity for use on short wave receivers. Provided with trimmer condenser. Has 1/2 in. shaft. Measures 1 3/8 x 1 7/8 x 2 1/4 inches. PRICE.....**75c**

Powertest 2 Gang .00014 Condenser

A 2 gang .00014 condenser especially adaptable for use on short-wave receivers. Each section is provided with individual trimmers. Has 1/2 inch shaft. Measures 4 x 2 1/4 x 2 1/4 inches. SPECIAL PRICE.....**69c**

R. M. A. 1 Watt Color Coded Resistance Kit

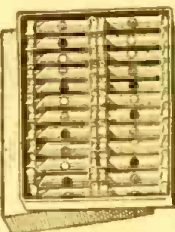

36 most commonly used resistances. Odd-size values obtainable by connecting two or more in series or parallel. The kit is comprised of the following resistances:

100	850	15,000	500,000
150	900	20,000	750,000
200	1,000	25,000	1 meg.
250	1,500	30,000	2 meg.
350	2,000	50,000	3 meg.
450	3,000	100,000	5 meg.
500	4,000	125,000	7 meg.
600	5,000	200,000	10 meg.
750	10,000	250,000	

\$3.45

FREE! 0-10,000 ohm resistance meter with each purchase of this kit.

Sangamo Push Pull Input and Output and Audio Transformers

The input transformer has a high primary inductance insuring maximum amplification at low frequencies. The secondary is accurately divided to secure practically identical frequency characteristics.



Output transformer has an impedance that matches the voice coil impedance of any standard type dynamic speaker. PRICE.....**\$1.25**

EACH.....**\$1.25**
 PER PAIR.....**\$2.45**

The curve of the audio transformer is as near perfect as possible. Well insulated and shielded. PRICE.....**\$1.45**

Farrand Magnetic Speaker Chassis

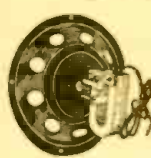

The Farrand chassis is one of the finest of magnetic speaker chassis available today. It has a balanced armature which enables the chassis to handle a large amount of volume without distorting or rattling. PRICE.....**\$1.95**

Powertone Midget Dynamic Speaker

Made by one of the largest speaker manufacturers in the country. Compact in size and reliable in tone quality. Transformers can be matched to the impedance of any output tube, thus assuring you perfect reproduction. Field resistance can be had in either 1800 ohms tapped at 300 for C bias, or 2900 ohms. PRICE.....**\$1.95**



POWER TEST Variable Midget Condensers

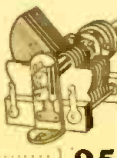

A small sized, light weight, low-loss, accurate condenser. These features indicate their use for ultra short-wave and short-wave tuning, broadcast tuning, antenna tuning, compensating and vernier condensers, and for laboratory and test equipment in general. Midline type .0001 capacity..... } **95c**
 Straight Line Frequency .00014 capacity..... }

TRY-MO RADIO CO. INC. 85 Cortlandt St. New York

BRANCH STORES

178 Greenwich St., N. Y. C. Near Dey St.

179 Greenwich St., N. Y. C. Near Cortlandt St.

Note: Send Mail Orders to Dept C5, 85 Cortlandt St., N. Y. C.

Our reputation has been founded on our **PROFIT SERVICE**. Every item that we advertise is always carried in stock and shipped at once to the purchaser. We realize the necessity for quick delivery. Buy at TRY-MO for guaranteed SERVICE.

MAY SPECIALS!!

EVERY month we list on this page certain **STAR** items, which are **NOT LISTED IN OUR CATALOG**. These are all specials of which the quantities on hand are not sufficient to catalog them. *Once sold out, no more can be had.* First come, first served. **ORDER NOW, TODAY.**

STOP SHOPPING. The lowest prices are right on this page. No one *undersells us.* We meet any price on ANY NEW Merchandise. Order direct from this page and save money. 100% satisfaction on every transaction. Take advantage of these special offers. **ORDER NOW, TODAY.**

Only
\$10.85

Greatest Buy In America!

Only
\$10.85

*"PEERLESS" 8-TUBE SCREEN-GRID T.R.F. RADIO RECEIVER

Complete with Full Dynamic Speaker

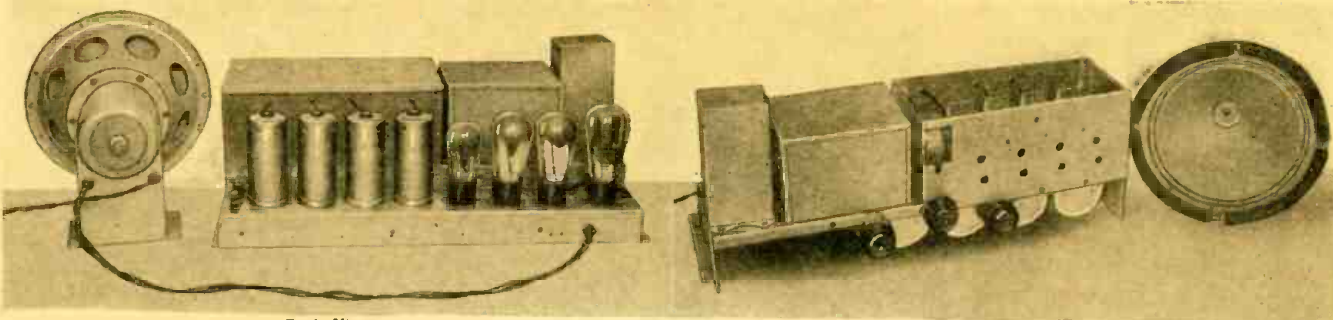

Back View

Front View

Limited Supply—Only as Long as They Last—Order Today

IF EVER there were a greater value than this offered before, we have yet to see it. The selectivity and sensitivity of this 8-tube receiver due to its four tuned stages are just as sharp as those of an extensive 11-tube Superheterodyne receiver. The construction of this receiver is best described as "standard." Its circuit is none other than the "good old standby" TRF type which is the most reliable and the most foolproof ever designed. It incorporates three stages of tuned R.F. amplification using type 24 Screen-grid tubes; the power detector is a 24; a single stage of AF voltage amplification utilizing the type 27 tube, feeds a pair of 45's in push pull, the full wave rectifier is an 80. All provisions are made for supplying field power for the 9 inch TCA (Transformer Corporation of America) full dynamic speaker. Both cone and speaker of this excellent reproducer are made of Burtex to improve the high note response (brilliance) without impairing the low note production. Tuning is extremely simple, the tuned circuits being controlled by a single central knob; a vernier drum-type illuminated tuning dial is employed. The second knob controls the on-off switch and the third, the one on the right, volume control. Coils, tuning-condenser-bank, filter condenser bank, output choke and by-pass condenser bank are all individually shielded. The chassis itself is made of non-magnetic aluminum.

The use of four tuned circuits, employing screen-grid tubes and high gain R.F. transformers, together with careful wiring, and by-passing, result in high sen-

sitivity. Many of our satisfied customers inform us that a good variety of distant stations come in like locals. Tone quality, too, is extraordinarily fine. Despite the maze of new tubes recently thrown upon the market, it is generally conceded that for average home use push pull 45's supply adequate power with the least distortion. Why build a set when a complete receiver, wired and ready to use, and complete with speaker, can be bought at this phenomenally low price? Here is an excellent opportunity for wide-awake service men to "clean up." There are little more than 100 of these receivers left and at this low price, they are bound to give out in very short order. Experimenters will find in this chassis the laboratory "monitor" they have been waiting to buy "when things got cheaper." Remember that the supply is limited. Hence, "first come, first served." The moral is don't delay, order today. Overall size 21" x 8" x 8 1/2" (set only). Ship. wt. 45 lbs.

List Price \$75.00

NO. SP-2000 Peerless 8-Tube TRF Receiver

YOUR PRICE with speaker but less tubes . . .

\$10.85

LIMITED SUPPLY—ORDER TODAY—TOMORROW MAY BE TOO LATE

Build Your Own "Dependable" Tube Tester!

Sold in Kit Form

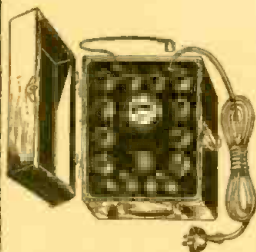

And now for the first time we present a complete kit of parts for building an advanced "DEPENDABLE" tube tester—an instrument which is MODERN in every sense of the word. Will test all the latest type tubes including those with 4, 5, 6 and 7 prongs—DIRECTLY—WITHOUT THE USE OF A SINGLE ADAPTER. Complete details for constructing this instrument were printed in the RADIO CRAFT magazine for April. (A copy of this magazine will be given FREE with each purchase.) Complete instructions are also furnished with each kit.

The "DEPENDABLE," despite its high degree of accuracy, is EXTREMELY SIMPLE TO OPERATE. Both plates of the 80-82-83 and other rectifiers are readily tested without the use of a "second plate" button. The condition of a given tube is manifested by its mutual conductance (emission) characteristic, which is clearly indicated on the meter. Employs a sensitive magnet-vane type meter but may be had with a moving-coil type meter at an additional cost of \$4.00.

(Please specify which when ordering.) Provides for a "SHORT" test which safeguards the life of the meter. Shorted tubes are automatically indicated on a pilot light.

Operates on 105-115-125 volts A.C. with provisions for securing the proper line voltage. ONLY FIRST-CLASS PARTS ARE USED THROUGHOUT. The kit is sold complete with beautifully lithographed panel and handsome leatherette case with deluxe trimmings. Overall dimensions of completed tube checker in case 11" x 9" x 5". Ship. wt. 8 lbs.

Here is what you receive: 1—drilled and lithographed panel 10" x 8"; 1—filament transformer; 1—0-15 MA. specially calibrated magnet-vane meter for moving coil meter—see above; 1—7 point filament selector switch; 1—4 point line voltage selector switch; 1—6-leaf jack switch; 1—3-leaf momentary contact switch; 1—S.P.D. T. toggle switch; 1—Helden soft rubber plug and cable; 10—wafer sockets for 4-5-6 and 7 prong tubes; 1—3 watt 7,000 ohm resistor; 1—10 watt 900 ohm resistor; 2—bakelite indicator knobs; 1—18 watt pilot lamp and socket; 2—switch buttons; 1—screen-grid cap and wire; 1—leatherette case; assorted hardware, wire, etc. Ship. wt. 8 lbs.

LIST PRICE \$27.50

No. 301 Dependable Tube Tester Kit **\$11.45**

YOUR PRICE

No. 301A Same as above but with Moving Coil Meter. YOUR PRICE **\$15.45**

Doerle 12,500 Mile Short-Wave Set

Although the Doerle is a low-priced receiver, yet it pulls in short-wave stations from all over the world. REGULARLY, in practically any location, not only in this country, but anywhere. Thousands of experimenters have built their own, and have obtained miraculous results. All the usual "bugs" have been ironed out by us in such a way that you may order every receiver with full confidence, that "it will do its stuff" anywhere. It is possible for us to sell cheaper parts for the complete receiver at a lower price. But then we could not guarantee its performance. Therefore only First Class Material is Used.

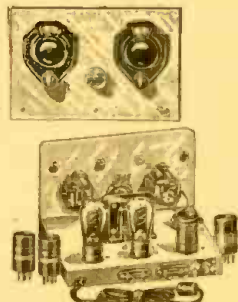

This receiver is exactly as illustrated. Size of aluminum panel is 9 x 6 1/2 inches; base 9 x 6 1/2 inches. List of material used: 2 Hammarlund 00014 Condensers; 1 Carter 20 ohm Rheostat and Switch; 1 standard Audio Transformer; 2 Kurtz-Kuehn Vernier Dials; 3 Bakelite Low Loss Sockets; 1 Mica Equalizer Antenna Condenser; 1-0001 mica Fixed Condenser; 1-5 megohm Carborundum Grid Leak; 2 Telephone Pin Jacks; 1 Aluminum Panel; 1 Veneer Baseboard; 1 Bakelite Rheostat Knob; 2 double binding posts; 1 set of 4 Low Loss Short-Wave Plug-in Coils; 4-page instruction pamphlet and blue prints; 1 Set of Hardware, Wire, etc. Complete shipping weight 5 lbs. No. 2141. TWO TUBE 12,500 MILE DOERLE SHORT-WAVE RECEIVER, completely wired and tested as per above specifications.

YOUR PRICE **\$8.90**

No. 2141. TWO TUBE 12,500 MILE DOERLE SHORT WAVE RECEIVER KIT, with all parts as specified above, but not wired, with blueprint connections and instructions for operation. Complete shipping weight 5 lbs.

YOUR PRICE **\$7.70**

No. 2142. COMPLETE ACCESSORIES including the following: 2 six months guaranteed Neontron type No. 230 tubes; one set of No. 1878 Brandes Matched Headphones; 2 No. 6 standard dry cells; 2 standard 45-volt "B" batteries. Complete shipping weight 22 lbs.

YOUR PRICE **\$5.40**

FREE RADIO AND SHORT WAVE TREATISE



The new Winter, 1933 edition of our Radio and Short-Wave Treatise, No. 26, has just come off the press—104 solid pages of useful information, radio items, diagrams and illustrations. Possesses the greatest book in print—NOT JUST ANOTHER CATALOG. Contains a large editorial section with valuable information not found anywhere else. Special consideration has been given to the radio beginner in this issue. Among the new technical information listed are the following:

HERE IS A PARTIAL LIST OF CONTENTS
Fundamental Principles of Radio—Ohm's Law—Discussion of New Tubes—Constructing a "Triple-Twin" Amplifier—All about Superheterodynes—Himer at a glance—M.A. Static—Constructing a Two-Tube Short-Wave Globe-Trotter Receiver—\$3.00 Prize Suggestions—Radio Kinks, etc., etc.

WRITE TODAY. Enclose 4 cents for postage. Treatise sent by return mail.

Over 100 New Hook-Ups, Etc. 1000 Illustrations.

WE ARE A WHOLESALE HOUSE AND CANNOT ACCEPT ORDERS FOR LESS THAN \$3.00. If C.O.D. shipment is desired, please remit 20% remittance, which must accompany all orders. If full cash accompanies order, deduct 2% discount. Send money order—certified check—U. S. stamps.

Radio Trading Co.
102 Park Place
New York, N. Y.

ORDER FROM THIS PAGE. You will find special prices from time to time in this magazine. Get our big FREE catalog for the greatest Radio Bargains. Should you wish goods shipped by parcel post, be sure to include sufficient extra remittance for same. Any excess will be refunded.

They Have Copied Everything—

Except **TRIAD** Quality

IT IS WRITTEN—

“Imitation is the sincerest form of flattery”

TRIAD

Appreciates the compliment it receives each month from other tube manufacturers who have copied our sales plan—our method of advertising—our discount schedules

TRIAD

Was first to recognize the Service Man

TRIAD

Was first to make double-tested tubes

TRIAD

Was first to offer a plan which really makes money for the dealer and Service Man

OTHERS

have made every effort to do the same thing

BUT

THEY HAVE NOT BEEN ABLE TO DUPLICATE

TRIAD → **Quality**

TUBES

A NEW DEAL

Some of our Service Men and Dealers have wanted to buy regular Triad Tubes to meet ordinary competition—

We have worked out a special proposition with most attractive discounts, and will be glad to supply the details upon request.

With regular Triads you can beat any kind of competition.

Triad Dealers and Service Men everywhere have sold many thousands of these tubes,—they are making money—there hasn't been a single complaint. Mail the coupon today and learn how you can sell these super-grade tubes at a real profit. We protect you in your territory and you are sure of all of the inducements offered by other manufacturers, plus quality which is in a class by itself. **GET THE FACTS!**

TRIAD Manufacturing Co.
Pawtucket, R. I.

Gentlemen:

Please send me the outline of the TRIAD Sales Plan for Dealers and Service Men.

Name.....

Address.....

City.....State.....

My letterhead or business card is attached

Announcing the New Idea in DX



LINCOLN R-9

9-200 METERS

The new R-9 has what one might say—a dual personality. In the hands of an expert commercial operator, the high sensitivity brings in CW and voice signals, impossible to hear on many receivers, with any volume you want. It has been a sensation to every “Ham” who worked it on the air.

In the hands of the “died in the wool” DXer it has filled the bill 100%. He can be the proud possessor of the most powerful strictly short wave receiver which he can demonstrate to his friends without interrupting the family broadcast receiver.

If you could bring in just half of the stations we bring in daily, regular as clock work, you would be just as enthusiastic as we are.

Don't forget you have the choice of the famous DeLuxe SW-33 all wave, if you prefer, which radio engineers, Army officers, and millionaires claim the greatest receiver they ever operated. The new super powered DeLuxe SW-33 cuts like a knife, absolutely 10KC from the powerful locals. Sensitivity beyond practical measurement and a new fidelity hard to equal in the finest amplifiers.

Just drop me a line and tell me what you want. If you are a licensed operator, please give call letters. I will send complete information on your request.

Cordially yours,

W. H. Hollister, President.

LINCOLN RADIO CORPORATION, 335 S. Wood St., Chicago

LINCOLN RADIO CORPORATION
Dept. E, 335 S. Wood St., Chicago U. S. A.
Please send me Free Technical description of the

R-9

SW-33

Name

Street

City..... State

LINCOLN
DeLuxe Receivers